

LANGUAGES AND CLASSIFICATION

John Scales Avery

October 27, 2017

Introduction

As children, many of us have played the game, “20 Questions”. In this game, someone thinks of a word. Then the other players try to guess the word by asking questions, to which the answer can only be “yes” or “no”. Only 20 questions are allowed, but the word is almost always found correctly with this number of questions or less. This may seem surprising, unless we happen to know that $2^{20} = 1,048,576$, whereas the Second Edition of the 20-volume Oxford English Dictionary contains full entries for only 171,476 words in current use.

Now I hope that the reader will forgive me if I indulge in some personal memories. Between 1950 and 1954, I was an undergraduate student of physics at the Massachusetts Institute of Technology. During this period, it occurred to me that an international language like Esperanto could be based on a system similar to “20 Questions”. The words in my invented language would be pronounceable, since they would alternate between vowels and consonants. The first few letters of the word would define the meaning in a rough way, and the following letters would specify the meaning more and more precisely.

I believed that my invented international language would be very easy to learn because a learner would know the approximate meaning of a word from the first few letters. I wrote an article about my idea, and it was published in MIT’s *Tech Engineering News*. However, I later realized that no invented language, neither Esperanto, nor any other, would be able to compete as an international language with English, which happens to be very widely used at the precise moment that communication has become global. The use of English is backed by a huge literature, and by endless productions of the entertainment industry. Nevertheless, I still believe that my invented language has some interest, perhaps in the context of communication between humans and computers, especially when the computers are able to duplicate some of the functions of human intelligence.

Fast forward more than half a century. In recent years I have become aware of Institute Professor Noam Chomsky’s pioneering work on the structure of languages and on universal grammars, and I have even exchanged a few letters with him. Prof. Chomsky has rightly pointed out that human languages are qualitatively different from the languages of animals. As we have just noted, more than a hundred thousand English words are currently in use, and no animal language comes close to matching this vocabulary size. Moreover, animal languages do not have the grammatical structure or the

combinatorial flexibility of human languages.

Prof. Chomsky also believes that the monumental linguistic abilities of humans were acquired very rapidly. This assertion implies that the human ability to quickly learn enormous numbers of words, as well as our innate tendency to use these words grammatically, can be traced back to a small number of mutations. I believe that we owe it to Prof. Chomsky's stature to take this assertion seriously, and to examine, using the full armory of molecular biology, the question of how a few mutations could have produced our astonishing linguistic abilities.

The 2014 Nobel Prize in Physiology or Medicine

Once again, I hope that the reader will forgive me if I indulge in personal recollections. In 2014 I watched a television program in which Edvard Moser, May-Britt Moser, and John O'Keefe, the three winners of the 2014 Nobel Prize in Physiology or Medicine delivered their lectures in Stockholm. They had received the prize for their discovery of the specific neural networks in animal brains and in human brains, which allow us to learn and remember the branching decision-trees needed to find our way from place to place.

I was already aware of Charles Darwin's discussion of serial homologies in *The Origin of Species*. Darwin discusses cases where symmetrically repeated parts of an ancient progenitor have been modified for special purposes in their descendants. For example, the bones which fit together to form the brain case in reptiles, birds and mammals can be seen in fossil sequences to be modified vertebrae of an ancient progenitor.

After discussing many examples, Darwin exclaims, "How inexplicable are these cases of serial homologies on the ordinary view of creation! Why should the brain be enclosed in a box composed of such numerous and extraordinarily-shaped pieces of bone?... Why should similar bones have been created to form the wing and leg of a bat, used as they are for totally different purposes, namely walking and flying? Why should one crustacean, which has an extremely complex mouth, formed of many parts, consequently have fewer legs; or conversely, those with many legs have simpler mouths? Why should the sepals, petals, stamens and pistils in each flower, though fitted for such distinct purposes, be all constructed on the same pattern?... On the theory of natural selection we can, to a certain extent, answer these questions.... An indefinite repetition of the same part is the common characteristic of all low or little-specialized forms... We have already seen that

parts many times repeated are eminently liable to vary... Consequently such parts, being already present in considerable numbers, and being highly variable, would naturally afford materials for adaption to the most different purposes.”

Listening to the 2014 Nobel lectures, with Darwin’s views in mind, it occurred to me that a single mutation could cause the duplication in humans of the neural networks that all animals use in pathfinding. Once duplicated, one copy of these networks might afterwards be modified to serve as a foundation for human languages.

There are many cases where a single mutation seems to have produced duplication of a structure. For example, we sometimes see the birth of an animal with two heads, or supernumerary legs. In the light of Professor Chomsky’s observation that human languages are qualitatively different from animal languages, and his belief that modern humans acquired their astonishing linguistic abilities very rapidly, we ought to investigate the possibility that a single mutation caused a duplication of the pathfinding neural networks studied by Edvard Moser, May-Britt Moser, and John O’Keefe. We can then imagine that one copy of this duplicated pathfinding neural network system was modified to serve as the basis of human languages, in which the classification of words is closely analogous to the tree-like branching choice-pathways of an animal finding its way through a forest or maze.¹

¹Bold face is used here because this paragraph contains the central message of this book.

Contents

1	LINNAEUS AND BIOLOGICAL CLASSIFICATION	7
1.1	Linnaeus	7
1.2	The language of Linnean classification	8
1.3	Erasmus Darwin	12
1.4	Charles Darwin	13
1.5	Aboard the Beagle	16
1.6	The Galapagos Islands	17
1.7	The Origin of Species	19
1.8	Classical genetics	25
2	CHEMICAL COMMUNICATION	31
2.1	The structure of DNA	31
2.2	The genetic code	40
2.3	The language of molecular complementarity	41
2.4	The flow of information between and within cells	44
2.5	Nervous systems	46
3	ANIMAL LANGUAGES	57
3.1	Communication of emotions	57
3.2	Pheromones	62
3.3	The waggle dance	63
3.4	Parrots and crows	64
3.5	Bushbabies	67
3.6	Washoe, Nim Chimpsky and Koko	67
4	OUT OF AFRICA	73
4.1	Early ancestors of modern humans	73
4.2	Y-chromosomal DNA and mitochondrial DNA	78
4.3	Exodus: Out of Africa	84
4.4	Joseph Greenberg's classification of languages and DNA analysis	86

5	PATHFINDING	93
5.1	The 2014 Nobel Prize in Medicine and Physiology	93
5.2	Paths in cell differentiation	101
5.3	Paths in package address systems	101
5.4	Paths in the organization of computer memories	103
5.5	Pattern abstraction	104
5.6	Abstraction of concepts and natural laws	114
6	THE EVOLUTION OF HUMAN LANGUAGES	129
6.1	Chomsky's assertion of rapid change	129
6.2	Parse trees	132
6.3	Garrod's hypothesis	133
6.4	The FOXP2 gene and protein	133
6.5	Slow evolutionary change; serial homologies	134
6.6	The Neanderthal and Denisovan genomes	135
7	CLASSIFICATION OF WORDS	141
7.1	Nouns	141
7.2	Pronouns	143
7.3	Adjectives	146
7.4	Verbs	147
7.5	Adverbs	148
7.6	Conjunctions	150
7.7	Prepositions	150
7.8	Interjections	151
7.9	Articles	151
8	SOME CONCLUDING REMARKS	153
8.1	Can invented languages be pronounced?	153
8.2	The evolution of consciousness	153
8.3	Dreaming and intelligence	154
8.4	The information explosion	155
8.5	Agriculture	155
8.6	Writing	156
8.7	Printing	157
8.8	An explosion of industry	158
8.9	An explosion of communication	158
8.10	An explosion of population	161
8.11	Paradox	163
8.12	Culture	172

Chapter 1

LINNAEUS AND BIOLOGICAL CLASSIFICATION

1.1 Linnaeus

During the 17th and 18th centuries, naturalists had been gathering information on thousands of species of plants and animals. This huge, undigested heap of information was put into some order by the great Swedish naturalist, Carl von Linné (1707-1778), who is usually called by his Latin name, Carolus Linnaeus.

Linnaeus was the son of a Swedish pastor. Even as a young boy, he was fond of botany, and after medical studies at Lund, he became a lecturer in botany at the University of Uppsala, near Stockholm. In 1732, the 25-year-old Linnaeus was asked by his university to visit Lapland to study the plants in that remote northern region of Sweden.



Figure 1.1: The great Swedish naturalist Carolus Linnaeus developed a language which is now universally used for biological classification.

1.2 The language of Linnean classification

Linnaeus travelled four thousand six hundred miles in Lapland, and he discovered more than a hundred new plant species. In 1735, he published his famous book, *Systema Naturae*, in which he introduced a method for the classification of all living things.

Linnaeus not only arranged closely related species into genera, but he also grouped related genera into classes, and related classes into orders. (Later the French naturalist Cuvier (1769-1832) extended this system by grouping related orders into phyla.) Linnaeus introduced the binomial nomenclature, still used today, in which each plant or animal is given a name whose second part denotes the species while the first part denotes the genus.

Linnaeus proposed three kingdoms, which were divided into classes. From classes, the groups were further divided into orders, families, genera (singular: genus), and species. An additional rank beneath species distinguished between highly similar organisms. While his system of classifying minerals has been discarded, a modified version of the Linnaean classification system is still used to identify and categorize animals and plants.

Although he started a line of study which led inevitably to the theory of evolution, Linnaeus himself believed that species are immutable. He adhered to the then-conventional view that each species had been independently and miraculously created six thousand years ago, as described in the Book of Genesis.

Linnaeus did not attempt to explain why the different species within a genus resemble each other, nor why certain genera are related and can be grouped into classes, etc. It was not until a century later that these resemblances were understood as true family likenesses, so that the resemblance between a cat

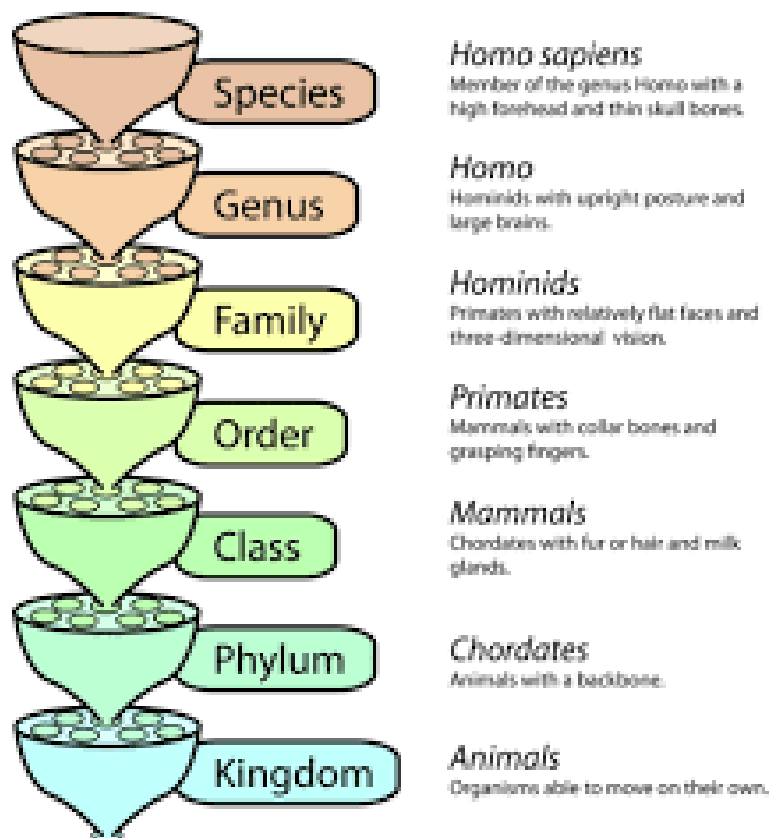

Figure 1.2: The branching decision-trees in the Linnean language of classification resembles the decision-trees in package-address systems such as postal systems of the Internet. Similar decision-trees are found when an animal finds its way through forest or maze.

and a lion came to be understood in terms of their descent from a common ancestor¹.

¹ Linnaeus was to Darwin what Kepler was to Newton. Kepler accurately described the motions of the solar system, but it remained for Newton to explain the underlying dynamical mechanism. Similarly, Linnaeus set forth a descriptive “family tree” of living things, but Darwin discovered the dynamic mechanism that underlies the observations.



Figure 1.3: Within the Animal kingdom, the polar bear belongs to the phylum Chordata, the class Mammalian, the order Carnivora, the family Ursidae, the genus Ursus, and the species Ursus arctos.

Kingdoms and classes

Animals

1. Mammalian (mammals)
2. Aves (birds)
3. Amphibia (amphibians)
4. Pisces (fish)
5. Insecta (insects)
6. Vermes (worms)

Plants

1. Monandria: flowers with 1 stamen
2. Diandria: flowers with 2 stamens
3. Triandria: flowers with 3 stamens
4. Tetrandria: flowers with 4 stamens
5. Pentandria: flowers with 5 stamens
6. Hexandria: flowers with 6 stamens

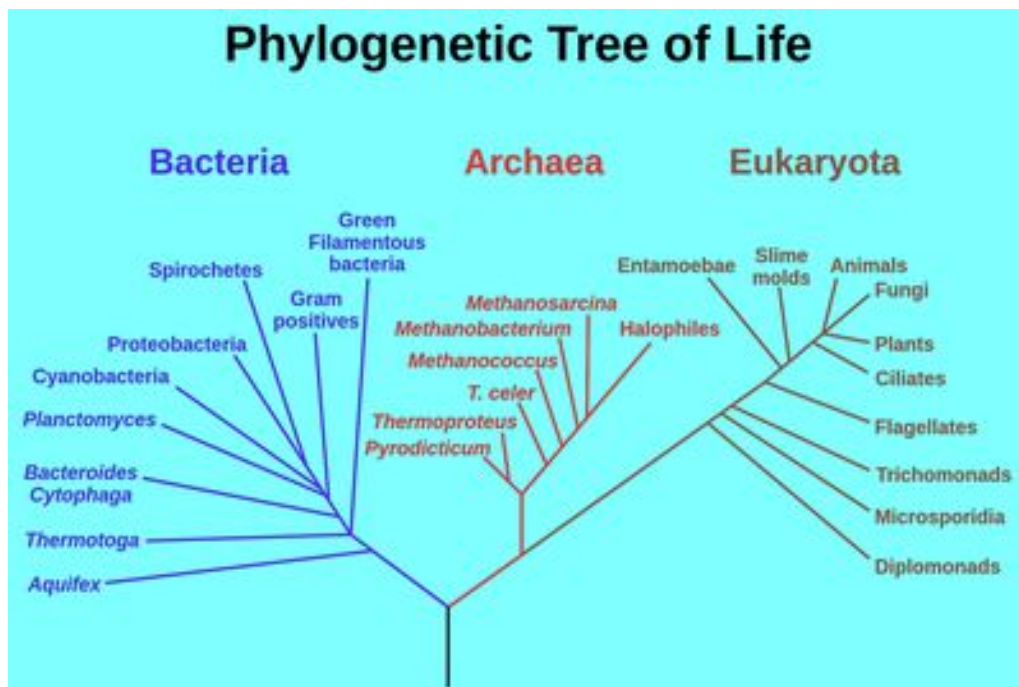

Figure 1.4: The three-domain system currently used to classify living organisms. Within each domain, the classification becomes progressively finer: From classes, the groups were further divided into orders, families, genera (singular: genus), and species. An additional rank beneath species distinguished between highly similar organisms. While his system of classifying minerals has been discarded, a modified version of the Linnaean classification system is still used to identify and categorize animals and plants.

7. Heptandria: flowers with 7 stamens
8. Octandria: flowers with 8 stamens
9. Enneandria: flowers with 9 stamens
10. Decandria: flowers with 10 stamens
11. Dodecandria: flowers with 12 stamens
12. Icosandria: flowers with 20 (or more) stamens
13. Polyandria: flowers with many stamens
14. Didynamia: flowers with 4 stamens, 2 long and 2 short
15. Tetradynamia: flowers with 6 stamens, 4 long and 2 short
16. Monadelphica; flowers with the anthers separate, but the filaments united at the base
17. Diadelphia; flowers with the stamens united in two groups
18. Polyadelphia; flowers with the stamens united in several groups
19. Syngenesia; flowers with 5 stamens having anthers united at the edges
20. Gynandria; flowers having stamens united to the pistils
21. Monoecia: monoecious plants
22. Dioecia: dioecious plants
23. Polygamia: polygamodioecious plants
24. Cryptogamia: organisms that resemble plants but don't have flowers, which included fungi, algae, ferns, and bryophytes

1.3 Erasmus Darwin

Among the ardent admirers of Linnaeus was the brilliant physician-poet, Erasmus Darwin (1731-1802), who was considered by Coleridge to have "...a greater range of knowledge than any other man in Europe". He was also the best English physician of his time, and George III wished to have him as his personal doctor. However, Darwin preferred to live in the north of England rather than in London, and he refused the position.

In 1789, Erasmus Darwin published a book called *The Botanic Garden or The Loves of the Plants*. It was a book of botany written in verse, and in the preface Darwin stated that his purpose was "...to inlist imagination under the banner of science.." and to call the reader's attention to "the immortal works of the celebrated Swedish naturalist, Linnaeus". This book was immensely popular at the time when it was written, but it was later satirized by Pitt's Foreign Minister, Canning, whose book *The Loves of the Triangles* ridiculed Darwin's poetic style.

In 1796 Erasmus Darwin published another book, entitled *Zoonomia*, in which he proposed a theory of evolution similar to that which his grandson, Charles Darwin, was later to make famous. "...When we think over the great changes introduced into various animals", Darwin wrote, "as in horses, which we have exercised for different purposes of strength and swiftness, carrying burthens or in running races; or in dogs, which have been cultivated for strength and courage, as the bull-dog; or for acuteness of his sense of smell, as in the hound and spaniel; or for the swiftness of his feet, as the greyhound; or for his swimming in the water, or for drawing snow-sledges, as the rough-haired dogs of the north... and add to these the great change of shape and color which we daily see produced in smaller animals from our domestication of them, as rabbits or pigeons;... when we revolve in our minds the great similarity of structure which obtains in all the warm-blooded animals, as well as quadrupeds, birds and amphibious animals, as in mankind, from the mouse and the bat to the elephant and whale; we are led to conclude that they have alike been produced from a similar living filament."

"Would it be too bold", Erasmus Darwin asked, "to imagine that in the great length of time since the earth began to exist, perhaps millions of ages before the commencement of the history of mankind - would it be too bold to imagine that all warm-blooded animals have arisen from one living filament?"

1.4 Charles Darwin

It was Erasmus Darwin's grandson Charles (1809-1882) who finally worked out a detailed and correct theory of evolution and supported it by a massive weight of evidence.

As a boy, Charles Darwin was passionately fond of hunting and collecting beetles, but he was a mediocre student. His father once said to him in exasperation: "You care for nothing but shooting, dogs and rat-catching; and you will be a disgrace to yourself, and to all your family!"

Darwin's father, a wealthy physician, sent him to Edinburgh University to study medicine; but Charles did not enjoy his studies there. "Dr. Duncan's

lectures on *Materia Medica* at 8 o'clock on a winter's morning are something fearful to remember", he wrote later. "I also attended the operating theatre in the hospital at Edinburgh and saw two very bad operations, one on a child, but I rushed away before they were completed. Nor did I ever attend again, for hardly any inducement would have been strong enough to make me do so; this being long before the blessed days of chloroform. The two cases fairly haunted me for many a long year."

The time at Edinburgh was not entirely wasted, however, because several of Darwin's friends at the university were natural philosophers², and contact with them helped to develop his interest in natural history. One of the most important of these scientific friends was Dr. R.E. Grant, an expert on marine invertebrate zoology with whom Darwin often collected small sea slugs in the cold waters of the Firth near Edinburgh. On one of these expeditions, Grant suddenly began to praise the evolutionary views of Lamarck, while Darwin listened in silent astonishment. Charles Darwin had previously read his own grandfather's book *Zoonomia* and had greatly admired it; but after a few years he had read it again in a more critical spirit; and after the second reading he had decided that *Zoonomia* was too speculative and contained too few facts. Grant's praise of Lamarck may have helped Darwin to become, later in his life, an advocate of evolution in a different form.

Darwin's father finally gave up the idea of making him into a doctor, and sent him instead to Cambridge to study for the clergy. At Cambridge, Darwin made many friends because of his unfailing good nature, enthusiasm and kindness. A friend from university days remembers that "at breakfast, wine or supper parties he was ever one of the most cheerful, the most popular and the most welcome... He was the most genial, warmhearted, generous and affectionate of friends."

Darwin's best friend during his last two years at Cambridge was the Reverend John Stevens Henslow, Professor of Botany. Darwin was often invited to Henslow's family dinner; and on most days he accompanied the professor on long walks, so that he became known as "the man who walks with Henslow". This friendship did much to develop Darwin's taste for natural history. Henslow's knowledge of botany, zoology and geology was vast; and he transmitted much of it to his enthusiastic young student during their long walks through the beautiful countryside near to the university. At Cambridge Darwin collected beetles; and the hobby became almost a passion for him. "One day, on tearing off some old bark", he wrote later, "I saw two rare beetles, and seized one in each hand. Then I saw a third kind, which I could not bear to lose, so I popped the one held in my right hand into my mouth.

² Today we would call them scientists.



Figure 1.5: Charles Darwin as a young man. In *The Origin of Species*, he showed that the biological classification proposed by Linnaeus corresponded to family trees, indicating descent from common ancestors.

Alas! It ejected some intensely acrid fluid which burnt my tongue, so that I was forced to spit the beetle out, which was lost, as was the third one.”

During his last year at Cambridge, Darwin read Alexander von Humboldt’s famous *Personal Narrative of Travels to the Equinoctial Regions of South America During the Years 1799-1804*, a book which awakened in him “a burning zeal to add even the most humble contribution to the noble structure of Natural Science”. Darwin longed to visit the glorious tropical forests described so vividly by von Humboldt.

Henslow persuaded Darwin to begin to study geology; and during the spring of 1831, Darwin joined the Professor of Geology, Adam Sedgwick, on an expedition to study the ancient rock formations in Wales. This expedition made Darwin realize that “science consists in grouping facts in such a way that general laws or conclusions may be drawn from them.” When Darwin returned from Wales, he found a letter from Professor George Peacock, forwarded by Henslow. “My dear Henslow”, Peacock’s letter read, “Captain Fitz-Roy is going out to survey the southern coast of Tierra del Fuego, and afterwards to visit many of the South Sea Islands, and to return by the Indian Archipelago... An offer has been made to me to recommend a proper person to go out as a naturalist with the expedition. He will be treated with every consideration. The Captain is a young man of very pleasant manners (a nephew of the Duke of Grafton), of great zeal in his profession and highly spoken of...”

In forwarding this letter to Darwin, Henslow added: “I have stated that I consider you to be the best qualified person I know of who is likely to undertake such a situation... The voyage is to last two years and if you take plenty of books with you, anything you please may be done... In short, I suppose that

there never was a finer chance for a young man of zeal and spirit...”

Darwin was beside himself with joy at this chance to follow in the footsteps of his hero, Alexander von Humboldt; but his plans were immediately squelched by the opposition of his father, who considered it “a wild scheme”, unsuitable for a future clergyman. “If you can find any man of common sense who advises you to go”, his father added, “I will give my consent.” Crushed by his father’s refusal, Charles Darwin visited his uncle’s family. Darwin’s favorite “Uncle Jos” was the son of the famous potter, Josiah Wedgwood, and the nearby Wedgwood estate at Maer was always a more relaxing place for him than his own home - a relief from the overpowering presence of his father. (His uncle’s many attractive daughters may also have had something to do with Darwin’s fondness for Maer.)

The Wedgwood family didn’t seem to think that sailing on the *Beagle* as naturalist would be a “wild scheme”, and Darwin’s Uncle Jos offered to drive him over to see whether the verdict could be changed. “My father always maintained that my uncle was one of the most sensible men in the world”, Darwin wrote later, “and he at once consented in the kindest manner.” Darwin had been rather extravagant while at Cambridge, and to console his father he said: “I should be deuced clever to spend more than my allowance whilst on board the *Beagle*.” His father answered with a smile: “But they tell me you are very clever.”

1.5 Aboard the Beagle

Thus it happened that on December 27, 1831, Charles Darwin sailed from Devonport on *H.M.S. Beagle*, a small brig of the British navy. The *Beagle*’s commander, Captain FitzRoy, was twenty-seven years old (four years older than Darwin), but he was already an excellent and experienced sailor. He had orders to survey the South American coast and to carry a chain of chronological measurements around the world. It was to be five years before the *Beagle* returned to England.

As the brig plowed through rough winter seas, Darwin lay in his hammock, miserably seasick and homesick, trying bravely to read a new book which Henslow had given to him as a sending-off present: Sir Charles Lyell’s *Principles of Geology*. It was an exciting and revolutionary book - so revolutionary, in fact, that Henslow had found it necessary to warn Darwin not to believe Lyell’s theories, but only to trust his observations. According to Lyell, “No causes have ever acted (in geology) but those which now are acting, and they have never acted with different degrees of energy from that which they

now exert.”³

Lyell’s hypothesis was directly opposed to the Catastrophist school of geology, a school which included deeply religious men like Cuvier, Henslow and Sedgwick, as well as most other naturalists of the time. The Catastrophists admitted that geological evidence shows the earth to be much older than the six thousand years calculated on the basis of the Bible, but they explained this by saying that the Bible describes only the most recent era. Before this, according to the Catastrophists, life on earth had been created many times, and just as many times destroyed by cataclysms like Noah’s flood.

Lyell’s book contradicted this whole picture. He believed the earth to be immensely old, and asserted that over thousands of millions of years, the same slow changes which we can still see taking place have accumulated to produce the earth’s great geological features. Over long ages, Lyell believed, gradual changes in the level of the land built up even the highest mountain ranges, while the slow action of rain and frost cut the peaks into valleys and planes.

1.6 Tha Galapagos Islands

After charting the Chilian coast, the *Beagle* sailed westward into the Pacific; and on September 15, 1835, the brig arrived at the Galapagos Archipelago, a group of strange volcanic islands about 500 miles from the mainland. Most of the species of plants, birds and animals which Darwin found on these islands were aboriginal species, found nowhere else in the world; yet in studying them he was continually reminded of species which he had seen on the South American continent. For example, a group of aboriginal finches which Darwin found on the Galapagos Islands were related to South American finches. The Galapagos finches were later shown to belong to thirteen separate species, all closely similar to each other, but differing in their habits and in the structure of their beaks.⁴

The geology of the islands showed that they had been pushed up from the bed of the sea by volcanic action in fairly recent times. Originally each island must have been completely bare of plants and animals. How had it been populated? The fact that the Galapagos species resembled those of the South American mainland made it seem probable to Darwin that the islands had become the home of chance wanderers from the continent. Seeds had perhaps drifted onto the shore and germinated, or perhaps they had been

³ This is the famous Principle of Uniformitarianism first formulated by Hutton and later developed in detail by Lyell.

⁴ Darwin was not even aware at the time that they were finches. It was on his return to London that an ornithologist friend identified them, noted their close relationship to an Ecuadorian finch, and Darwin came to understand their significance.



Figure 1.6: Charles Darwin as an old man, surrounded by the finches which he studied on the Galapagos Islands

brought to the islands in the stomachs of birds. Land birds, like the Galapagos finches, could have been blown there by storms. Perhaps a flock of a single species of finch had arrived, storm-driven, on the black volcanic shores of the islands. Over the centuries, as the finches multiplied, their beaks could have become adapted to the various forms of food available. “The most curious fact”, Darwin wrote later, “is the perfect gradation in the size of the beaks in the various species... Seeing this gradation and diversity in one small, intimately related group of birds, one might really fancy that from an original paucity of birds in this archipelago, one species had been taken and modified for different ends.. Here... we seem to be brought somewhat near to that great fact - that mystery of mysteries - the first appearance of new beings on this earth”.

The idea of the gradual modification of species could also explain the fact, observed by Darwin, that the fossil animals of South America were more closely related to African and Eurasian animals than were the living South American

species. In other words, the fossil animals of South America formed a link between the living South American species and the corresponding animals of Europe, Asia and Africa. The most likely explanation for this was that the animals had crossed to America on a land bridge which had since been lost, and that they had afterwards been modified.

1.7 The Origin of Species

In 1837 Darwin had begun a notebook on Transmutation of Species. During the voyage of the *Beagle* he had been deeply impressed by the great fossil animals which he had discovered, so like existing South American species except for their gigantic size. Also, as the *Beagle* had sailed southward, he had noticed the way in which animals were replaced by closely allied species. On the Galapagos Islands, he had been struck by the South American character of the unique species found there, and by the way in which they differed slightly on each island.

It seemed to Darwin that these facts, as well as many other observations which he had made on the voyage, could only be explained by assuming that species gradually became modified. The subject haunted him, but he was unable to find the exact mechanism by which species changed. Therefore he resolved to follow the Baconian method, which his friend Sir Charles Lyell had used so successfully in geology. He hoped that by the wholesale collection of all facts related in any way to the variation of animals and plants under domestication and in nature, he might be able to throw some light on the subject. He soon saw that in agriculture, the key to success in breeding new varieties was selection; but how could selection be applied to organisms living in a state of nature?

In October 1838, 15 months after beginning his systematic enquiry, Darwin happened to read Malthus' book on population.⁵ After his many years as a naturalist, carefully observing animals and plants, Darwin was very familiar with the struggle for existence which goes on everywhere in nature; and it struck him immediately that under the harsh conditions of this struggle, favorable variations would tend to survive while unfavorable ones would perish. The result would be the formation of new species!

Darwin had at last got a theory on which to work, but he was so anxious to avoid prejudice that he did not write it down. He continued to collect facts, and it was not until 1842 that he allowed himself to write a 35-page

⁵ *An Essay on the Principle of Population, or, A View of its Past and Present Effects, with an Inquiry into our Prospects Respecting its Future Removal or Mitigation of the Evils which it Occasions*, 2nd edn, Johnson, London (1803)

sketch of his theory. In 1844 he enlarged this sketch to 230 pages, and showed it to his friend Sir Joseph Hooker, the Director of Kew Botanical Gardens. However, Darwin did not publish his 1844 sketch. Probably he foresaw the storm of bitter hostility which his heretical theory was to arouse. In England at that time, Lamarckian ideas from France were regarded as both scientifically unrespectable and politically subversive. The hierarchal English establishment was being attacked by the Chartist movement, and troops had been called out to suppress large scale riots and to ward off revolution. Heretical ideas which might undermine society were regarded as extremely dangerous. Darwin himself was a respected member of the establishment, and he was married to a conservative and devout wife, whose feelings he wished to spare. So he kept his work on species private, confiding his ideas only to Hooker and Lyell.

Instead of publishing his views on evolution, Darwin began an enormous technical study of barnacles, which took him eight years to finish. Hooker had told him that no one had the right to write on the question of the origin of species without first having gone through the detailed work of studying a particular species. Also, barnacles were extremely interesting to Darwin: They are in fact more closely related to shrimps and crabs than to molluscs.

Finally, in 1854, Darwin cleared away the last of his barnacles and began to work in earnest on the transmutation of species through natural selection, arranging the mountainous piles of notes on the subject which he had accumulated over the years. By 1858 he had completed the first part of a monumental work on evolution. If he had continued writing on the same scale, he would ultimately have produced a gigantic, unreadable multivolume opus. Fortunately this was prevented: A young naturalist named Alfred Russell Wallace, while ill with a fever in Malaya, also read Malthus on Population; and in a fit of inspiration he arrived at a theory of evolution through natural selection which was identical with Darwin's! Wallace wrote out his ideas in a short paper with the title: *On the Tendency of Varieties to Depart Indefinitely from the Original Type*. He sent this paper to Darwin with the request that if Darwin thought the paper good, he should forward it to Lyell.

Lyell had for years been urging Darwin to publish his own work on natural selection, telling him that if he delayed, someone else would reach the same conclusions. Now Lyell's warning had come true with a vengeance, and Darwin's first impulse was to suppress all his own work in favor of Wallace. In a letter to Lyell, Darwin wrote: "I would far rather burn my whole book than that he or any other man should think that I had behaved in a paltry spirit." Darwin's two good friends, Lyell and Hooker, firmly prevented this however; and through their intervention a fair compromise was reached: Wallace's paper, together with an extract from Darwin's 1844 sketch on natural selection, were read jointly to the Linnean Society (which listened in stunned silence).

At the urging of Lyell and Hooker, Darwin now began an abstract of his enormous unfinished book. This abstract, entitled *On The Origin of Species by Means of Natural Selection, or The Preservation of Favoured Races in the Struggle for Life*, was published in 1859. It ranks with Newton's *Principia* as one of the two greatest scientific books ever written.

Darwin's *Origin of Species* can still be read with enjoyment and fascination by a modern reader. His style is vivid and easy to read, and almost all of his conclusions are still believed to be true. Darwin begins his great book with a history of evolutionary ideas. He starts with a quotation from Aristotle, who was groping towards the idea of natural selection: "Wheresoever, therefore... all the parts of one whole happened like as if they were made for something, these were preserved, having been appropriately constituted by an internal spontaneity; and wheresoever things were not thus constituted, they perished, and still perish." Darwin lists many others who contributed to evolutionary thought, including the Chevalier de Lamarck, Geoffroy Saint-Hillaire, Alfred Russell Wallace, and his own grandfather, Erasmus Darwin.

Next, Darwin reminds us of the way in which mankind has produced useful races of domestic animals and plants by selecting from each generation those individuals which show any slight favorable variation, and by using these as parents for the next generation. A closely similar process occurs in nature, Darwin tells us: Wild animals and plants exhibit slight variations, and in nature there is always a struggle for existence. This struggle follows from the fact that every living creature produces offspring at a rate which would soon entirely fill up the world if no check ever fell on the growth of population. We often have difficulty in seeing the exact nature of these checks, since living organisms are related to each other and to their environment in extremely complex ways, but the checks must always be present.

Accidental variations which increase an organism's chance of survival are more likely to be propagated to subsequent generations than are harmful variations. By this mechanism, which Darwin called "natural selection", changes in plants and animals occur in nature just as they do under the artificial selection exercised by breeders.

If we imagine a volcanic island, pushed up from the ocean floor and completely uninhabited, we can ask what will happen as plants and animals begin to arrive. Suppose, for example, that a single species of bird arrives on the island. The population will first increase until the environment cannot support larger numbers, and it will then remain constant at this level. Over a long period of time, however, variations may accidentally occur in the bird population which allow the variant individuals to make use of new types of food; and thus, through variation, the population may be further increased.

In this way, a single species "radiates" into a number of sub-species which

fill every available ecological niche. The new species produced in this way will be similar to the original ancestor species, although they may be greatly modified in features which are related to their new diet and habits. Thus, for example, whales, otters and seals retain the general structure of land-going mammals, although they are greatly modified in features which are related to their aquatic way of life. This is the reason, according to Darwin, why vestigial organs are so useful in the classification of plant and animal species.

The classification of species is seen by Darwin as a genealogical classification. All living organisms are seen, in his theory, as branches of a single family tree. This is a truly remarkable assertion, since the common ancestors of all living things must have been extremely simple and primitive; and it follows that the marvelous structures of the higher animals and plants, whose complexity and elegance utterly surpasses the products of human intelligence, were all produced, over thousands of millions of years, by random variation and natural selection!

Each structure and attribute of a living creature can therefore be seen as having a long history; and a knowledge of the evolutionary history of the organs and attributes of living creatures can contribute much to our understanding of them. For instance, studies of the evolutionary history of the brain and of instincts can contribute greatly to our understanding of psychology, as Darwin pointed out.

Among the many striking observations presented by Darwin to support his theory, are facts related to morphology and embryology. For example, Darwin includes a quotation from the naturalist, von Baer, who stated that he had in his possession two embryos preserved in alcohol, which he had forgotten to label. Von Baer was completely unable to tell by looking at them whether they were embryos of lizards, birds or mammals, since all these species are so similar at an early stage of development.

Darwin also quotes the following passage from G.H. Lewis: "The tadpole of the common Salamander has gills, and passes its existence in the water; but the *Salamandra atra*, which lives high up in the mountains, brings forth its young full-formed. This animal never lives in the water. Yet if we open a gravid female, we find tadpoles inside her with exquisitely feathered gills; and when placed in water, they swim about like the tadpoles of the common Salamander or water-newt. Obviously this aquatic organization has no reference to the future life of the animal, nor has it any adaptation to its embryonic condition; it has solely reference to ancestral adaptations; it repeats a phase in the development of its progenitors."

Darwin points out that, "...As the embryo often shows us more or less plainly the structure of the less modified and ancient progenitor of the group, we can see why ancient and extinct forms so often resemble in their adult state

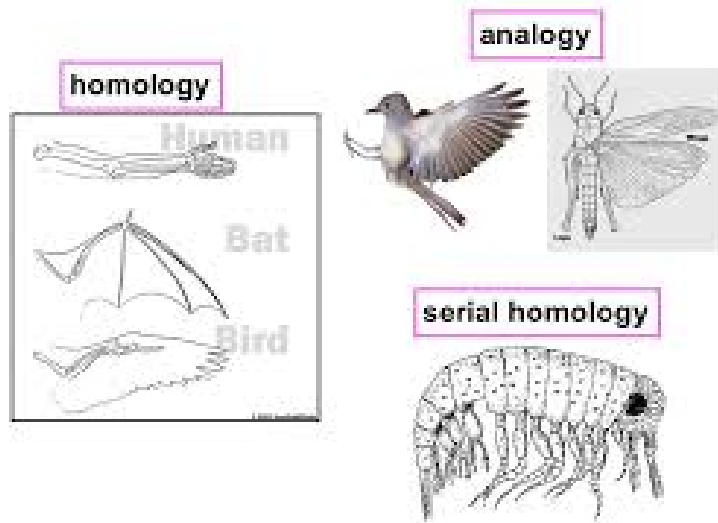
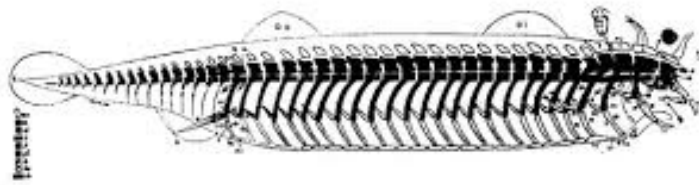

Figure 1.7: Serial homologies are comparisons between multiply repeated parts which, through evolution, have been modified to serve different purposes.

the embryos of existing species.”

Darwin sets forth another line of argument in support of evolution based on “serial homologies”, - cases where symmetrically repeated parts of an ancient progenitor have been modified for special purposes in their descendants. For example, the bones which fit together to form the brain case in reptiles, birds and mammals can be seen in fossil sequences to be modified vertebrae of an ancient progenitor. After discussing many examples, Darwin exclaims, “How inexplicable are these cases of serial homologies on the ordinary view of creation! Why should the brain be enclosed in a box composed of such numerous and extraordinarily-shaped pieces of bone?... Why should similar bones have been created to form the wing and leg of a bat, used as they are for totally different purposes, namely walking and flying? Why should one crustacean, which has an extremely complex mouth, formed of many parts, consequently have fewer legs; or conversely, those with many legs have simpler mouths? Why should the sepals, petals, stamens and pistils in each flower, though fitted for such distinct purposes, be all constructed on the same pattern?... On the theory of natural selection we can, to a certain extent, answer these questions.... An indefinite repetition of the same part is the common characteristic of all low or little-specialized forms... We have already seen that parts many times repeated are eminently liable to vary... Consequently such parts, being already present in considerable numbers, and being highly variable, would naturally afford materials for adaption to the most different purposes.”



Ideal archetype skeleton

Fig. 3.

Figure 1.8: In vertebrates, the repeated sections of the spinal column may be modified to serve different purposes.

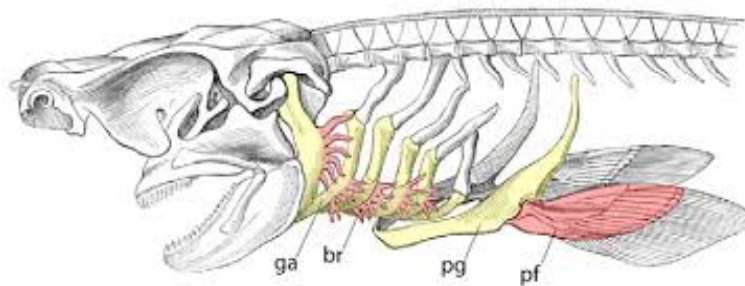

Figure 1.9: In fish, the evolutionary origin of both the gills and the fins can be traced back to the multiply repeated elements of the spinal column.

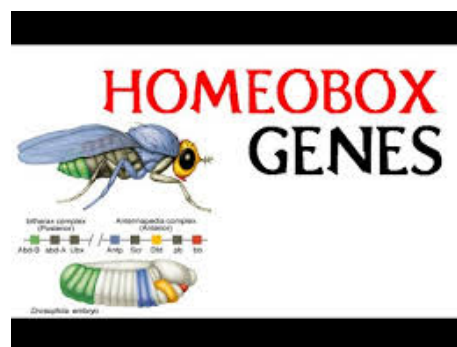

Figure 1.10: The *homeobox genes* are thought to be involved in multiply repeated parts of organisms.

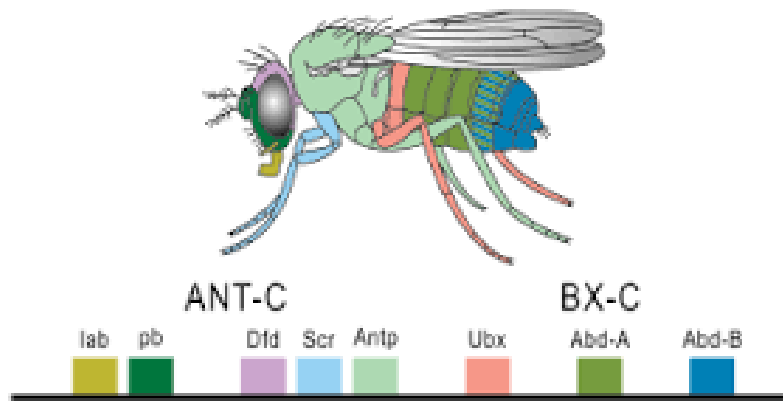

Figure 1.11: An illustration showing repeated parts of a fly which have been modified for different purposes.

1.8 Classical genetics

Charles Darwin postulated that natural selection acts on small inheritable variations in the individual members of a species. His opponents objected that these slight variations would be averaged away by interbreeding. Darwin groped after an answer to this objection, but he did not have one. However, unknown to Darwin, the answer had been uncovered several years earlier by an obscure Augustinian monk, Gregor Mendel, who was born in Silesia in 1822, and who died in Bohemia in 1884.

Mendel loved both botany and mathematics, and he combined these two interests in his hobby of breeding peas in the monastery garden. Mendel carefully self-pollinated his pea plants, and then wrapped the flowers to prevent pollination by insects. He kept records of the characteristics of the plants and their offspring, and he found that dwarf peas always breed true - they invariably produce other dwarf plants. The tall variety of pea plants, pollinated with themselves, did not always breed true, but Mendel succeeded in isolating a strain of true-breeding tall plants which he inbred over many generations.

Next he crossed his true-breeding tall plants with the dwarf variety and produced a generation of hybrids. All of the hybrids produced in this way were tall. Finally Mendel self-pollinated the hybrids and recorded the characteristics of the next generation. Roughly one quarter of the plants in this new generation were true-breeding tall plants, one quarter were true-breeding dwarfs, and one half were tall but not true-breeding.

Gregor Mendel had in fact discovered the existence of dominant and recessive genes. In peas, dwarfism is a recessive characteristic, while tallness is

dominant. Each plant has two sets of genes, one from each parent. Whenever the gene for tallness is present, the plant is tall, regardless of whether it also has a gene for dwarfism. When Mendel crossed the pure-breeding dwarf plants with pure-breeding tall ones, the hybrids received one type of gene from each parent. Each hybrid had a tall gene and a dwarf gene; but the tall gene was dominant, and therefore all the hybrids were tall. When the hybrids were self-pollinated or crossed with each other, a genetic lottery took place. In the next generation, through the laws of chance, a quarter of the plants had two dwarf genes, a quarter had two tall genes, and half had one of each kind.

Mendel published his results in the *Transactions of the Brunn Natural History Society* in 1865, and no one noticed his paper⁶. At that time, Austria was being overrun by the Prussians, and people had other things to think about. Mendel was elected Abbot of his monastery; he grew too old and fat to bend over and cultivate his pea plants; his work on heredity was completely forgotten, and he died never knowing that he would one day be considered to be the founder of modern genetics.

In 1900 the Dutch botanist named Hugo de Vries, working on evening primroses, independently rediscovered Mendel's laws. Before publishing, he looked through the literature to see whether anyone else had worked on the subject, and to his amazement he found that Mendel had anticipated his great discovery by 35 years. De Vries could easily have published his own work without mentioning Mendel, but his honesty was such that he gave Mendel full credit and mentioned his own work only as a confirmation of Mendel's laws. Astonishingly, the same story was twice repeated elsewhere in Europe during the same year. In 1900, two other botanists (Correns in Berlin and Tschermak in Vienna) independently rediscovered Mendel's laws, looked through the literature, found Mendel's 1865 paper, and gave him full credit for the discovery.

Besides rediscovering the Mendelian laws for the inheritance of dominant and recessive characteristics, de Vries made another very important discovery: He discovered genetic mutations - sudden unexplained changes of form which can be inherited by subsequent generations. In growing evening primroses, de Vries found that sometimes, but very rarely, a completely new variety would suddenly appear, and he found that the variation could be propagated to the following generations. Actually, mutations had been observed before the time of de Vries. For example, a short-legged mutant sheep had suddenly appeared during the 18th century; and stock-breeders had taken advantage of this mutation to breed sheep that could not jump over walls. However, de Vries was the first scientist to study and describe mutations. He noticed that most mutations are harmful, but that a very few are beneficial, and those few

⁶ Mendel sent a copy of his paper to Darwin; but Darwin, whose German was weak, seems not to have read it.

tend in nature to be propagated to future generations.

After the rediscovery of Mendel's work by de Vries, many scientists began to suspect that chromosomes might be the carriers of genetic information. The word "chromosome" had been invented by the German physiologist, Walther Flemming, to describe the long, threadlike bodies which could be seen when cells were stained and examined through the microscope during the process of division. It had been found that when an ordinary cell divides, the chromosomes also divide, so that each daughter cell has a full set of chromosomes.

The Belgian cytologist, Edouard van Benedin, had shown that in the formation of sperm and egg cells, the sperm and egg receive only half of the full number of chromosomes. It had been found that when the sperm of the father combines with the egg of the mother in sexual reproduction, the fertilized egg again has a full set of chromosomes, half coming from the mother and half from the father. This was so consistent with the genetic lottery studied by Mendel, de Vries and others, that it seemed almost certain that chromosomes were the carriers of genetic information.

The number of chromosomes was observed to be small (for example, each normal cell of a human has 46 chromosomes); and this made it obvious that each chromosome must contain thousands of genes. It seemed likely that all of the genes on a particular chromosome would stay together as they passed through the genetic lottery; and therefore certain characteristics should always be inherited together.

Suggestions for further reading

1. P.J. Bowler, *Evolution: The History of an Idea*, University of California Press, (1989).
2. D.J. Putuyma, *Evolutionary Biology*, Sinauer Associates, Sunderland Mass., (1986).
3. B. Glass, O. Temkin, and W.L. Strauss, eds., *Forerunners of Darwin: 1745-1859*, Johns Hopkins Press, Baltimore, (1959).
4. R. Milner, *The Encyclopedia of Evolution*, an Owl Book, Henry Holt and Company, New York, (1990).
5. T.A. Appel, *The Cuvier-Geoffroy Debate: French Biology in the Decades before Darwin*, Oxford University Press, (1987).
6. P.J. Bowler, *Fossils and Progress: Paleontology and the Idea of Progressive Evolution in the Nineteenth Century*, Science History Publications, New York, (1976).
7. H. Torrens, *Presidential Address: Mary Anning (1799-1847) of Lyme; 'the greatest fossilist the world ever knew'*, British Journal of the History of Science, **28**, 257-284, (1995).

8. P. Corsi, *The Age of Lamarck: Evolutionary Theories in France, 1790-1834*, University of California Press, Berkeley, (1988).
9. C.C. Gillispie, *Genesis and Geology: A Study in the Relations of Scientific Thought, Natural Theology and Social Opinion in Great Britain, 1790-1850*, Harvard University Press, Cambridge Mass., (1951).
10. M. McNeil, *Under the Banner of Science: Erasmus Darwin and his Age*, Manchester University Press, Manchester, (1987).
11. L.G. Wilson, *Sir Charles Lyell's Scientific Journals on the Species Question*, Yale University Press, New Haven, (1970).
12. M. 'Espinasse, *Robert Hooke, 2nd ed.*, U. of California Press, (1962).
13. M.J.S. Rudwick, *The Meaning of Fossils: Episodes in the History of Paleontology, 2nd ed.*, University of Chicago Press, (1985).
14. A.B. Adams, *Eternal Quest: The Story of the Great Naturalists*, G.P. Putnam's Sons, New York, (1969).
15. A.S. Packard, *Lamarck, the Founder of Evolution: His Life and Work*, Longmans, Green, and Co., New York, (1901).
16. C. Darwin, *An historical sketch of the progress of opinion on the Origin of Species, previously to the publication of this work*, Appended to third and later editions of *On the Origin of Species*, (1861).
17. L. Eiseley, *Darwin's Century: Evolution and the Men who Discovered It*, Doubleday, New York, (1958).
18. H.F. Osborne, *From the Greeks to Darwin: The Development of the Evolution Idea Through Twenty-Four Centuries*, Charles Scribner and Sons, New York, (1929).
19. Sir Julian Huxley and H.B.D. Kettlewell, *Charles Darwin and his World*, Thames and Hudson, London, (1965).
20. Allan Moorehead, *Darwin and the Beagle*, Penguin Books Ltd., (1971).
21. Francis Darwin (editor), *The Autobiography of Charles Darwin and Selected Letters*, Dover, New York, (1958).
22. Charles Darwin, *The Voyage of the Beagle*, J.M. Dent and Sons Ltd., London, (1975).
23. Charles Darwin, *The Origin of Species*, Collier MacMillan, London, (1974).
24. Charles Darwin, *The Expression of Emotions in Man and Animals*, The University of Chicago Press (1965).
25. D.W. Forest, *Francis Galton, The Life and Work of a Victorian Genius*, Paul Elek, London (1974).
26. Ruth Moore, *Evolution*, Time-Life Books (1962).
27. L. Barber, *The Heyday of Natural History: 1820-1870*, Doubleday and Co., Garden City, New York, (1980).
28. A. Desmond, *Huxley*, Addison Wesley, Reading, Mass., (1994).

29. R. Owen, (P.R. Sloan editor), *The Hunterian Lectures in Comparative Anatomy*, May-June, 1837, University of Chicago Press, (1992).
30. C. Nichols, *Darwinism and the social sciences*, Phil. Soc. Scient. 4, 255-277 (1974).
31. M. Ruse, *The Darwinian Revolution*, University of Chicago Press, (1979).
32. A. Desmond and J. Moore, *Darwin*, Penguin Books, (1992).
33. R. Dawkins, *The Extended Phenotype*, Oxford University Press, (1982).
34. R. Dawkins, *The Blind Watchmaker*, W.W. Norton, (1987).
35. R. Dawkins, *River out of Eden: A Darwinian View of Life*, Harper Collins, (1995).
36. R. Dawkins, *Climbing Mount Improbable*, W.W. Norton, (1996).
37. S.J. Gould, *Ever Since Darwin*, W.W. Norton, (1977).
38. S.J. Gould, *The Panda's Thumb*, W.W. Norton, (1980).
39. S.J. Gould, *Hen's Teeth and Horse's Toes*, W.W. Norton, (1983).
40. S.J. Gould, *The Burgess Shale and the Nature of History*, W.W. Norton, (1989).
41. R.G.B. Reid, *Evolutionary Theory: The Unfinished Synthesis*, Croom Helm, (1985).
42. M. Ho and P.T. Saunders, editors, *Beyond Neo-Darwinism: An Introduction to a New Evolutionary Paradigm*, Academic Press, London, (1984).
43. J. Maynard Smith, *Did Darwin Get it Right? Essays on Games, Sex and Evolution*, Chapman and Hall, (1989).
44. E. Sober, *The Nature of Selection: Evolutionary Theory in Philosophical Focus*, University of Chicago Press, (1984).
45. B.K. Hall, *Evolutionary Developmental Biology*, Chapman and Hall, London, (1992).
46. J. Thompson, *Interaction and Coevolution*, Wiley and Sons, (1982).
47. N. Tinbergen, *The Study of Instinct*, Oxford University Press, (1951).
48. N. Tinbergen, *Social Behavior in Animals*, Methuen, London, (1953).
49. N. Tinbergen, *The Animal in its World: Explorations of an Ethologist*, Allan and Unwin, London, (1973).
50. K. Lorenz, *On the evolution of behavior*, Scientific American, December, (1958).
51. K. Lorenz, *Studies in Animal and Human Behavior. I and II.*, Harvard University Press, (1970) and (1971).
52. P.H. Klopfer and J.P. Hailman, *An Introduction to Animal Behavior: Ethology's First Century*, Prentice-Hall, New Jersey, (1969).
53. J. Jaynes, *The historical origins of "Ethology" and "Comparative Psychology"*, Anim. Behav. 17, 601-606 (1969).
54. W.H. Thorpe, *The Origin and Rise of Ethology: The Science of the Natural Behavior of Animals*, Heinemann, London, (1979).

55. R.A. Hinde, *Animal Behavior: A Synthesis of Ethological and Comparative Psychology*, McGraw-Hill, New York, (1970).
56. J.H. Crook, editor, *Social Behavior in Birds and Mammals*, Academic Press, London, (1970).
57. P. Ekman, editor, *Darwin and Facial Expression*, Academic Press, New York, (1973).
58. P. Ekman, W.V. Friesen and P. Ekworth, *Emotions in the Human Face*, Pergamon, New York, (1972).
59. N. Burton Jones, editor, *Ethological Studies of Child Behavior*, Cambridge University Press, (1975).
60. M. von Cranach, editor, *Methods of Inference from Animals to Human Behavior*, Chicago/Mouton, Haag, (1976); Aldine, Paris, (1976).
61. K. Lorenz, *On Aggression*, Bantam Books, (1977).
62. I. Eibl-Eibesfeld, *Ethology, The Biology of Behavior*, Holt, Rinehart and Winston, New York, (1975).
63. P.P.G. Bateson and R.A. Hinde, editors, *Growing Points in Ethology*, Cambridge University Press, (1976).
64. J. Bowlby, *By ethology out of psychoanalysis: An experiment in interbreeding*, *Animal Behavior*, **28**, 649-656 (1980).
65. B.B. Beck, *Animal Tool Behavior*, Garland STPM Press, New York, (1980).
66. R. Axelrod, *The Evolution of Cooperation*, Basic Books, New York, (1984).
67. J.D. Carthy and F.L. Ebling, *The Natural History of Aggression*, Academic Press, New York, (1964)
68. D.L. Cheney and R.M. Seyfarth, *How Monkeys See the World: Inside the Mind of Another Species*, University of Chicago Press, (1990).
69. F. De Waal, *Chimpanzee Politics*, Cape, London, (1982).
70. M. Edmunds, *Defense in Animals*, Longman, London, (1974).
71. R.D. Estes, *The Behavior Guide to African Mammals*, University of California Press, Los Angeles, (1991).
72. R.F. Ewer, *Ethology of Mammals*, Logos Press, London, (1968).

Chapter 2

CHEMICAL COMMUNICATION

2.1 The structure of DNA

Until 1944, most scientists had guessed that the genetic message was carried by the proteins of the chromosome. In 1944, however, O.T. Avery and his co-workers at the laboratory of the Rockefeller Institute in New York performed a critical experiment, which proved that the material which carries genetic information is not protein, but deoxyribonucleic acid (DNA) - a giant chain-like molecule which had been isolated from cell nuclei by the Swiss chemist, Friedrich Miescher.

Avery had been studying two different strains of pneumococci, the bacteria which cause pneumonia. One of these strains, the S-type, had a smooth coat, while the other strain, the R-type, lacked an enzyme needed for the manufacture of a smooth carbohydrate coat. Hence, R-type pneumococci had a rough appearance under the microscope. Avery and his co-workers were able to show that an extract from heat-killed S-type pneumococci could convert the living R-type species permanently into S-type; and they also showed that this extract consisted of pure DNA.

In 1947, the Austrian-American biochemist, Erwin Chargaff, began to study the long, chainlike DNA molecules. It had already been shown by Levine and Todd that chains of DNA are built up of four bases: adenine (A), thymine (T), guanine (G) and cytosine (C), held together by a sugar-phosphate backbone. Chargaff discovered that in DNA from the nuclei of living cells, the amount of A always equals the amount of T; and the amount of G always equals the amount of C.

When Chargaff made this discovery, neither he nor anyone else understood its meaning. However, in 1953, the mystery was completely solved by Ros-

alind Franklin and Maurice Wilkins at Kings College, London, together with James Watson and Francis Crick at Cambridge University. By means of X-ray diffraction techniques, Wilkins and Franklin obtained crystallographic information about the structure of DNA. Using this information, together with Linus Pauling's model-building methods, Crick and Watson proposed a detailed structure for the giant DNA molecule.

The discovery of the molecular structure of DNA was an event of enormous importance for genetics, and for biology in general. The structure was a revelation! The giant, helical DNA molecule was like a twisted ladder: Two long, twisted sugar-phosphate backbones formed the outside of the ladder, while the rungs were formed by the base pairs, A, T, G and C. The base adenine (A) could only be paired with thymine (T), while guanine (G) fit only with cytosine (C). Each base pair was weakly joined in the center by hydrogen bonds - in other words, there was a weak point in the center of each rung of the ladder - but the bases were strongly attached to the sugar-phosphate backbone. In their 1953 paper, Crick and Watson wrote:

"It has not escaped our notice that the specific pairing we have postulated suggests a possible copying mechanism for genetic material". Indeed, a sudden blaze of understanding illuminated the inner workings of heredity, and of life itself.

If the weak hydrogen bonds in the center of each rung were broken, the ladderlike DNA macromolecule could split down the center and divide into two single strands. Each single strand would then become a template for the formation of a new double-stranded molecule.

Because of the specific pairing of the bases in the Watson-Crick model of DNA, the two strands had to be complementary. T had to be paired with A, and G with C. Therefore, if the sequence of bases on one strand was (for example) TTTGCTAAAGGTGAACCA... , then the other strand necessarily had to have the sequence AAACGATTTCCACTTGGT... The Watson-Crick model of DNA made it seem certain that all the genetic information needed for producing a new individual is coded into the long, thin, double-stranded DNA molecule of the cell nucleus, written in a four-letter language whose letters are the bases, adenine, thymine, guanine and cytosine.

The solution of the DNA structure in 1953 initiated a new kind of biology - molecular biology. This new discipline made use of recently-discovered physical techniques - X-ray diffraction, electron microscopy, electrophoresis, chromatography, ultracentrifugation, radioactive tracer techniques, autoradiography, electron spin resonance, nuclear magnetic resonance and ultraviolet spectroscopy. In the 1960's and 1970's, molecular biology became the most exciting and rapidly-growing branch of science.

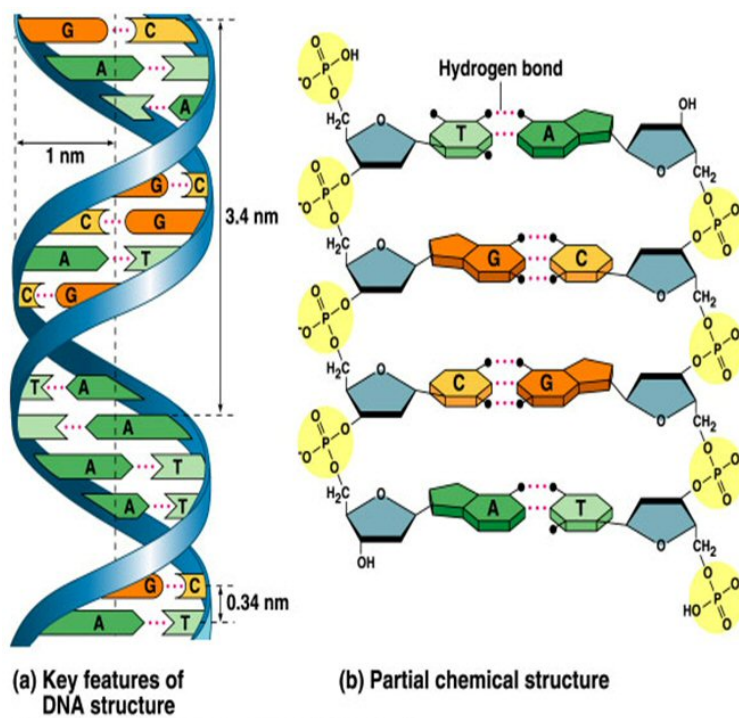

Figure 2.1: Once the structure of DNA was known, it became clear that transgenerational information is transmitted in a chemical language based on a code with four letters, G, T, C and A.

Protein structure

In England, J.D. Bernal and Dorothy Crowfoot Hodgkin pioneered the application of X-ray diffraction methods to the study of complex biological molecules. In 1949, Hodgkin determined the structure of penicillin; and in 1955, she followed this with the structure of vitamin B12. In 1960, Max Perutz and John C. Kendrew obtained the structures of the blood proteins myoglobin and hemoglobin. This was an impressive achievement for the Cambridge crystallographers, since the hemoglobin molecule contains roughly 12,000 atoms.

The structure obtained by Perutz and Kendrew showed that hemoglobin is a long chain of amino acids, folded into a globular shape, like a small, crumpled ball of yarn. They found that the amino acids with an affinity for water were on the outside of the globular molecule; while the amino acids for which contact with water was energetically unfavorable were hidden on the inside. Perutz and Kendrew deduced that the conformation of the protein - the way in which the chain of amino acids folded into a 3-dimensional structure - was determined by the sequence of amino acids in the chain.

In 1966, D.C. Phillips and his co-workers at the Royal Institution in London found the crystallographic structure of the enzyme lysozyme (an egg-white protein which breaks down the cell walls of certain bacteria). Again, the structure showed a long chain of amino acids, folded into a roughly globular shape. The amino acids with hydrophilic groups were on the outside, in contact with water, while those with hydrophobic groups were on the inside. The structure of lysozyme exhibited clearly an active site, where sugar molecules of bacterial cell walls were drawn into a mouth-like opening and stressed by electrostatic forces, so that bonds between the sugars could easily be broken.

Meanwhile, at Cambridge University, Frederick Sanger developed methods for finding the exact sequence of amino acids in a protein chain. In 1945, he discovered a compound (2,4-dinitrofluorobenzene) which attaches itself preferentially to one end of a chain of amino acids. Sanger then broke down the chain into individual amino acids, and determined which of them was connected to his reagent. By applying this procedure many times to fragments of larger chains, Sanger was able to deduce the sequence of amino acids in complex proteins. In 1953, he published the sequence of insulin. This led, in 1964, to the synthesis of insulin.

The biological role and structure of proteins which began to emerge was as follows: A mammalian cell produces roughly 10,000 different proteins. All enzymes are proteins; and the majority of proteins are enzymes - that is, they catalyze reactions involving other biological molecules. All proteins are built from chainlike polymers, whose monomeric sub-units are the following twenty amino acids: glycine, alanine, valine, isoleucine, leucine, serine, threonine, pro-

line, aspartic acid, glutamic acid, lysine, arginine, asparagine, glutamine, cysteine, methionine, tryptophan, phenylalanine, tyrosine and histidine. These individual amino acid monomers may be connected together into a polymer (called a polypeptide) in any order - hence the great number of possibilities. In such a polypeptide, the backbone is a chain of carbon and nitrogen atoms showing the pattern ...-C-C-N-C-C-N-C-C-N-...and so on. The -C-C-N- repeating unit is common to all amino acids. Their individuality is derived from differences in the side groups which are attached to the universal -C-C-N-group.

Some proteins, like hemoglobin, contain metal atoms, which may be oxidized or reduced as the protein performs its biological function. Other proteins, like lysozyme, contain no metal atoms, but instead owe their biological activity to an active site on the surface of the protein molecule. In 1909, the English physician, Archibald Garrod, had proposed a one-gene-one-protein hypothesis. He believed that hereditary diseases are due to the absence of specific enzymes. According to Garrod's hypothesis, damage suffered by a gene results in the faulty synthesis of the corresponding enzyme, and loss of the enzyme ultimately results in the symptoms of the hereditary disease.

In the 1940's, Garrod's hypothesis was confirmed by experiments on the mold, *Neurospora*, performed at Stanford University by George Beadle and Edward Tatum. They demonstrated that mutant strains of the mold would grow normally, provided that specific extra nutrients were added to their diets. The need for these dietary supplements could in every case be traced to the lack of a specific enzyme in the mutant strains. Linus Pauling later extended these ideas to human genetics by showing that the hereditary disease, sickle-cell anemia, is due to a defect in the biosynthesis of hemoglobin.

RNA and ribosomes

Since DNA was known to carry the genetic message, coded into the sequence of the four nucleotide bases, A, T, G and C, and since proteins were known to be composed of specific sequences of the twenty amino acids, it was logical to suppose that the amino acid sequence in a protein was determined by the base sequence of DNA. The information somehow had to be read from the DNA and used in the biosynthesis of the protein.

It was known that, in addition to DNA, cells also contain a similar, but not quite identical, polynucleotide called ribonucleic acid (RNA). The sugar-phosphate backbone of RNA was known to differ slightly from that of DNA; and in RNA, the nucleotide thymine (T) was replaced by a chemically similar nucleotide, uracil (U). Furthermore, while DNA was found only in cell nuclei,

RNA was found both in cell nuclei and in the cytoplasm of cells, where protein synthesis takes place. Evidence accumulated indicating that genetic information is first transcribed from DNA to RNA, and afterwards translated from RNA into the amino acid sequence of proteins.

At first, it was thought that RNA might act as a direct template, to which successive amino acids were attached. However, the appropriate chemical complementarity could not be found; and therefore, in 1955, Francis Crick proposed that amino acids are first bound to an adaptor molecule, which is afterward bound to RNA.

In 1956, George Emil Palade of the Rockefeller Institute used electron microscopy to study subcellular particles rich in RNA (ribosomes). Ribosomes were found to consist of two subunits - a smaller subunit, with a molecular weight one million times the weight of a hydrogen atom, and a larger subunit with twice this weight.

It was shown by means of radioactive tracers that a newly synthesized protein molecule is attached temporarily to a ribosome, but neither of the two subunits of the ribosome seemed to act as a template for protein synthesis. Instead, Palade and his coworkers found that genetic information is carried from DNA to the ribosome by a messenger RNA molecule (mRNA). Electron microscopy revealed that mRNA passes through the ribosome like a punched computer tape passing through a tape-reader. It was found that the adapter molecules, whose existence Crick had postulated, were smaller molecules of RNA; and these were given the name "transfer RNA" (tRNA). It was shown that, as an mRNA molecule passes through a ribosome, amino acids attached to complementary tRNA adaptor molecules are added to the growing protein chain.

The relationship between DNA, RNA, the proteins and the smaller molecules of a cell was thus seen to be hierarchical: The cell's DNA controlled its proteins (through the agency of RNA); and the proteins controlled the synthesis and metabolism of the smaller molecules.

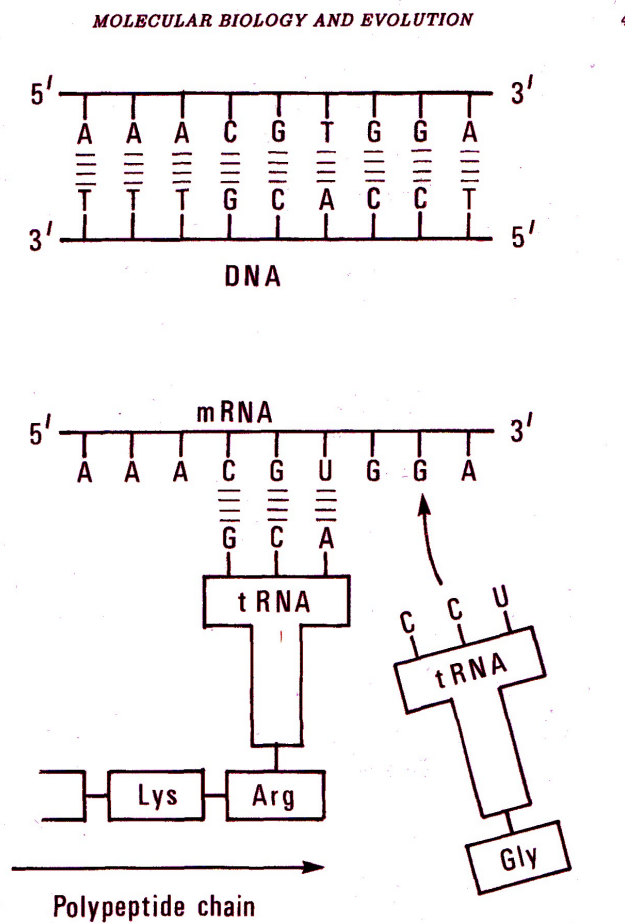

Figure 2.2: Information coded on DNA molecules in the cell nucleus is transcribed to mRNA molecules. The messenger RNA molecules in turn provide information for the amino acid sequence in protein synthesis.

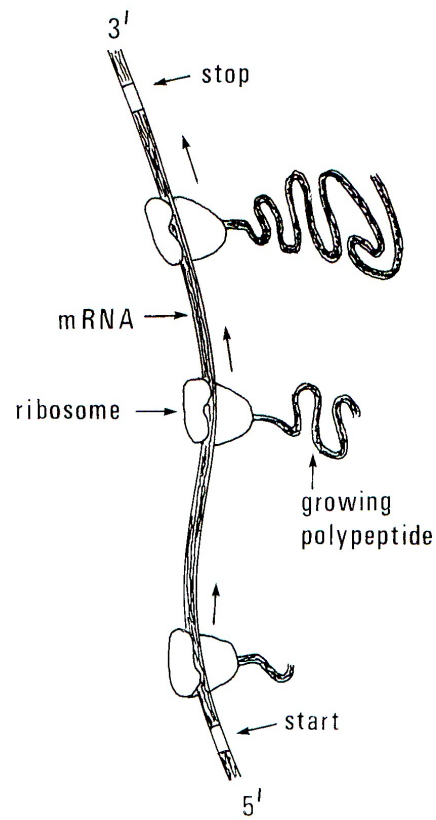

Figure 2.3: mRNA passes through the ribosome like a punched computer tape passing through a tape-reader.

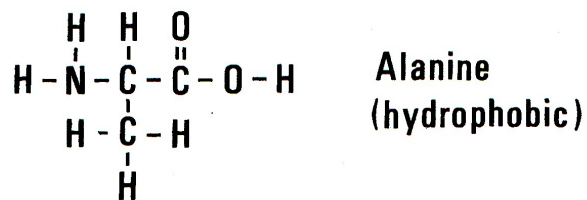
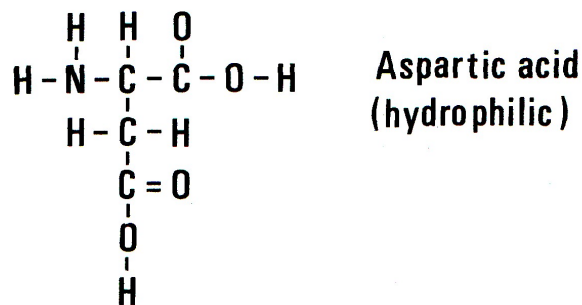
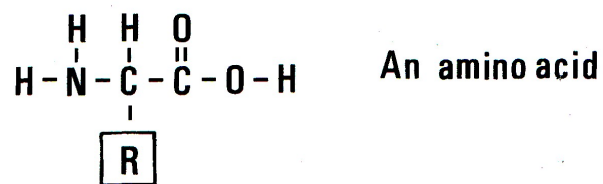

Figure 2.4: This figure shows aspartic acid, whose residue (R) is hydrophilic, contrasted with alanine, whose residue is hydrophobic.

2.2 The genetic code

In 1955, Severo Ochoa, at New York University, isolated a bacterial enzyme (RNA polymerase) which was able to join the nucleotides A, G, U and C so that they became an RNA strand. One year later, this feat was repeated for DNA by Arthur Kornberg.

With the help of Ochoa's enzyme, it was possible to make synthetic RNA molecules containing only a single nucleotide - for example, one could join uracil molecules into the ribonucleic acid chain, ...U-U-U-U-U-U-... In 1961, Marshall Nirenberg and Heinrich Matthaei used synthetic poly-U as messenger RNA in protein synthesis; and they found that only polyphenylalanine was synthesized. In the same year, Sydney Brenner and Francis Crick reported a series of experiments on mutant strains of the bacteriophage, T4. The experiments of Brenner and Crick showed that whenever a mutation added or deleted either one or two base pairs, the proteins produced by the mutants were highly abnormal and non-functional. However, when the mutation added or subtracted three base pairs, the proteins often were functional. Brenner and Crick concluded that the genetic language has three-letter words (codons). With four different "letters", A, T, G and C, this gives sixty-four possible codons - more than enough to specify the twenty different amino acids.

In the light of the phage experiments of Brenner and Crick, Nirenberg and Matthaei concluded that the genetic code for phenylalanine is UUU in RNA and TTT in DNA. The remaining words in the genetic code were worked out by H. Gobind Khorana of the University of Wisconsin, who used other mRNA sequences (such as GUGUGU..., AAGAAGAAG... and GUUGUUGUU...) in protein synthesis. By 1966, the complete genetic code, specifying amino acids in terms of three-base sequences, was known. The code was found to be the same for all species studied, no matter how widely separated they were in form; and this showed that all life on earth belongs to the same family, as postulated by Darwin.

Table 2.1: The genetic code

TTT=Phe	TCT=Ser	TAT=Tyr	TGT=Cys
TTC=Phe	TCC=Ser	TAC=Tyr	TGC=Cys
TTA=Leu	TCA=Ser	TAA=Ter	TGA=Ter
TTG=Leu	TGC=Ser	TAG=Ter	TGG=Trp
CTT=Leu	CCT=Pro	CAT=His	CGT=Arg
CTC=Leu	CCC=Pro	CAC=His	CGC=Arg
CTA=Leu	CCA=Pro	CAA=Gln	CGA=Arg
CTG=Leu	CGC=Pro	CAG=Gln	CGG=Arg
ATT=Ile	ACT=Thr	AAT=Asn	AGT=Ser
ATC=Ile	ACC=Thr	AAC=Asn	AGC=Ser
ATA=Ile	ACA=Thr	AAA=Lys	AGA=Arg
ATG=Met	AGC=Thr	AAG=Lys	AGG=Arg
GTT=Val	GCT=Ala	GAT=Asp	GGT=Gly
GTC=Val	GCC=Ala	GAC=Asp	GGC=Gly
GTA=Val	GCA=Ala	GAA=Glu	GGA=Gly
GTG=Val	GGC=Ala	GAG=Glu	GGG=Gly

2.3 The language of molecular complementarity

In living (and even non-living) systems, signals can be written and read at the molecular level. The language of molecular signals is a language of complementarity. The first scientist to call attention to complementarity and pattern recognition at the molecular level was Paul Ehrlich, who was born in 1854 in Upper Silesia (now a part of Poland). Ehrlich was not an especially good student, but his originality attracted the attention of his teacher, Professor Waldeyer, under whom he studied chemistry at the University of Strasbourg. Waldeyer encouraged him to do independent experiments with the newly-discovered aniline dyes; and on his own initiative, Ehrlich began to use these dyes to stain bacteria. He was still staining cells with aniline dyes a few years later (by this time he had become a medical student at the University of Breslau) when the great bacteriologist Robert Koch visited the laboratory. “This is young Ehrlich, who is very good at staining, but will never pass his examinations”, Koch was told. Nevertheless, Ehrlich did pass his examinations, and he went on to become a doctor of medicine at the University of Leipzig at the age of 24. His doctoral thesis dealt with the specificity of the aniline dyes:

Each dye stained a special class of cell and left all other cells unstained.

Paul Ehrlich had discovered what might be called “the language of molecular complementarity”: He had noticed that each of his aniline dyes stained only a particular type of tissue or a particular species of bacteria. For example, when he injected one of his blue dyes into the ear of a rabbit, he found to his astonishment that the dye molecules attached themselves selectively to the nerve endings. Similarly, each of the three types of phagocytes could be stained with its own particular dye, which left the other two kinds unstained¹.

Ehrlich believed that this specificity came about because the side chains on his dye molecules contained groupings of atoms which were complementary to groups of atoms on the surfaces of the cells or bacteria which they selectively stained. In other words, he believed that biological specificity results from a sort of lock and key mechanism: He visualized a dye molecule as moving about in solution until it finds a binding site which exactly fits the pattern of atoms in one of its side chains. Modern research has completely confirmed this picture, with the added insight that we now know that the complementarity of the “lock” and “key” is electrostatic as well as spatial.

Two molecules in a biological system may fit together because the contours of one are complementary to the contours of the other. This is how Paul Ehrlich visualized the fit - a spatial (steric) complementarity, like that of a lock and key. However, we now know that for maximum affinity, the patterns of excess charges on the surfaces of the two molecules must also be complementary. Regions of positive excess charge on the surface of one molecule must fit closely with regions of negative excess charge on the other if the two are to bind maximally. Thus the language of molecules is not only a language of contours, but also a language of charge distributions.

¹ The specificity which Ehrlich observed in his staining studies made him hope that it might be possible to find chemicals which would attach themselves selectively to pathogenic bacteria in the blood stream and kill the bacteria without harming normal body cells. He later discovered safe cures for both sleeping sickness and syphilis, thus becoming the father of chemotherapy in medicine. He had already received the Nobel Prize for his studies of the mechanism of immunity, but after his discovery of a cure for syphilis, a street in Frankfurt was named after him!

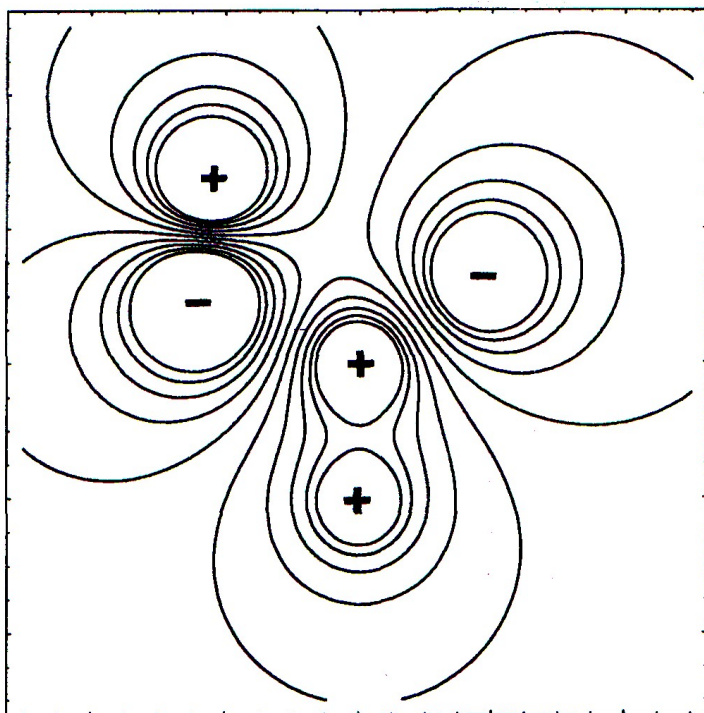

Figure 2.5: This figure shows the excess charges and the resulting electrostatic potential on a molecule of formic acid, HCOOH . The two oxygens in the carboxyl group are negatively charged, while the carbon and the two hydrogens have positive excess charges. Molecular recognition involves not only steric complementarity, but also complementarity of charge patterns.

2.4 The flow of information between and within cells

Information is transferred between cells in several ways. Among bacteria, in addition to the chronologically vertical transfer of genetic information directly from a single parent to its two daughter cells on cell division, there are mechanisms for the sharing of genetic information in a chronologically horizontal way, between cells of the same generation. These horizontal genetic information transfers can be thought of as being analogous to sex, as will be seen more clearly from some examples.

In the most primitive mechanism of horizontal information transfer, a bacterium releases DNA into its surroundings, and the DNA is later absorbed by another bacterium, not necessarily of the same species. For example, a loop or plasmid of DNA conferring resistance to an antibiotic (an “R-factor”) can be released by a resistant bacterium and later absorbed by a bacterium of another species, which then becomes resistant².

A second mechanism for horizontal information transfer involves infection of a bacterium by a virus. As the virus reproduces itself inside the bacterium, some of the host’s DNA can chance to be incorporated in the new virus particles, which then carry the extra DNA to other bacteria.

Finally, there is a third mechanism (discovered by J. Lederberg) in which two bacteria come together and construct a conjugal bridge across which genetic information can flow.

Almost all multicellular animals and plants reproduce sexually. In the case of sexual reproduction the genetic information of both parents is thrown into a lottery by means of special cells, the gametes. Gametes of each parent contain only half the genetic information of the parent, and the exact composition of that half is determined by chance. Thus, when the gametes from two sexes fuse to form a new individual, the chances for variability are extremely large. This variability is highly valuable to multicellular organisms which reproduce sexually, not only because variability is the raw material of evolutionary adaptation to changes in the environment, but also because the great variability of sexually-reproducing organisms makes them less likely to succumb to parasites. Infecting bacteria might otherwise deceive the immune systems of their hosts

² The fact that this can happen is a strong reason for using antibiotics with great caution in agriculture. Resistance to antibiotics can be transferred from the bacteria commonly found in farm animals to bacteria which are dangerous for humans. Microbiologists have repeatedly warned farmers, drug companies and politicians of this danger, but the warnings have usually been ignored. Unfortunately there are now several instances of antibiotic-resistant human pathogens that have been produced by indiscriminate use of antibiotics in agriculture.

by developing cell-surface antigens which resemble those of the host, but when they infect sexually-reproducing organisms where each individual is unique, this is much less likely.

Within the cells of all organisms living today, there is a flow of information from polynucleotides (DNA and RNA) to proteins. As messenger RNA passes through a ribosome, like punched tape passing through a computer tapereader, the sequence of nucleotides in the mRNA is translated into the sequence of nucleic acids in the growing protein. The molecular mechanism of the reading and writing in this process involves not only spatial complementarity, but also complementarity of charge distributions.

As a protein grows, one amino acid at a time, it begins to fold. The way in which it folds (the "tertiary conformation") is determined both by spatial complementarity and by complementarity of charge distributions: Those amino acids which have highly polar groups, i.e., where several atoms have large positive or negative excess charges - "hydrophilic" amino acids - tend to be placed on the outside of the growing protein, while amino acids lacking large excess charges - "hydrophobic" amino acids - tend to be on the inside, away from water. Hydrophilic amino acids form hydrogen bonds with water molecules. Whenever there is a large negative charge on an atom of an amino acid, it attracts a positively-charged hydrogen from water, while positively-charged hydrogens on nucleic acids are attracted to negatively charged oxygens of water. Meanwhile, in the interior of the growing protein, non-polar amino acids are attracted to each other by so-called van der Waals forces, which do not require large excess charges, but only close proximity.

When a protein is complete, it is ready to participate in the activities of the cell, perhaps as a structural element or perhaps as an enzyme. Enzymes catalyze the processes by which carbohydrates, and other molecules used by the cell, are synthesized. Often an enzyme has an "active site", where such a process takes place. Not only the spatial conformation of the active site but also its pattern of excess charges must be right if the catalysis is to be effective. An enzyme sometimes acts by binding two smaller molecules to its active site in a proper orientation to allow a reaction between them to take place. In other cases, substrate molecules are stressed and distorted by electrostatic forces as they are pulled into the active site, and the activation energy for a reaction is lowered.

Thus, information is transferred first from DNA and RNA to proteins, and then from proteins to (for example) carbohydrates. Sometimes the carbohydrates then become part of surface of a cell. The information which these surface carbohydrates ("cell surface antigens") contain may be transmitted to other cells. In this entire information transfer process, the "reading" and "writing" depend on steric complementarity and on complementarity of molecular

charge distributions.

Not only do cells communicate by touching each other and recognizing each other's cell surface antigens - they also communicate by secreting and absorbing transmitter molecules. For example, the group behavior of slime mold cells is coordinated by the cyclic adenosine monophosphate molecules, which the cells secrete when distressed.

Within most multicellular organisms, cooperative behavior of cells is coordinated by molecules such as hormones - chemical messengers. These are recognized by "receptors", the mechanism of recognition once again depending on complementarity of charge distributions and shape. Receptors on the surfaces of cells are often membrane-bound proteins which reach from the exterior of the membrane to the interior. When an external transmitter molecule is bound to a receptor site on the outside part of the protein, it causes a conformational change which releases a bound molecule of a different type from a site on the inside part of the protein, thus carrying the signal to the cell's interior. In other cases the messenger molecule passes through the cell membrane.

In this way the individual cell in a society of cells (a multicellular organism) is told when to divide and when to stop dividing, and what its special role will be in the economy of the cell society (differentiation). For example, in humans, follicle-stimulating hormone, lutenizing hormone, prolactin, estrogen and progesterone are among the chemical messengers which cause the cell differentiation needed to create the secondary sexual characteristics of females.

Another role of chemical messengers in multicellular organisms is to maintain a reasonably constant internal environment in spite of drastic changes in the external environment of individual cells or of the organism as a whole (homeostasis). An example of such a homeostatic chemical messenger is the hormone insulin, which is found in humans and other mammals. The rate of its release by secretory cells in the pancreas is increased by high concentrations of glucose in the blood. Insulin carries the news of high glucose levels to target cells in the liver, where the glucose is converted to glycogen, and to other target cells in the muscles, where the glucose is burned.

2.5 Nervous systems

Hormones require a considerable amount of time to diffuse from the cells where they originate to their target cells; but animals often need to act very quickly, in fractions of seconds, to avoid danger or to obtain food. Because of the need for quick responses, a second system of communication has evolved - the system of neurons.

Neurons have a cell bodies, nuclei, mitochondria and other usual features of

eukaryotic cells, but in addition they possess extremely long and thin tubelike extensions called axons and dendrites. The axons function as informational output channels, while the dendrites are inputs. These very long extensions of neurons connect them with other neurons which can be at distant sites, to which they are able to transmit electrical signals. The complex network of neurons within a multicellular organism, its nervous system, is divided into three parts. A sensory or input part brings in signals from the organism's interior or from its external environment. An effector or output part produces a response to the input signal, for example by initiating muscular contraction. Between the sensory and effector parts of the nervous system is a message-processing (internuncial) part, whose complexity is not great in the jellyfish or the leech. However, the complexity of the internuncial part of the nervous system increases dramatically as one goes upward in the evolutionary order of animals, and in humans it is truly astonishing.

The small button-like connections between neurons are called synapses. When an electrical signal propagating along an axon reaches a synapse, it releases a chemical transmitter substance into the tiny volume between the synapse and the next neuron (the post-synaptic cleft). Depending on the nature of the synapse, this chemical messenger may either cause the next neuron to "fire" (i.e., to produce an electrical pulse along its axon) or it may inhibit the firing of the neuron. Furthermore, the question of whether a neuron will or will not fire depends on the past history of its synapses. Because of this feature, the internuncial part of an animal's nervous system is able to learn. There are many kinds of synapses and many kinds of neurotransmitters, and the response of synapses is sensitive to the concentration of various molecules in the blood, a fact which helps to give the nervous systems of higher animals extraordinary subtlety and complexity.

The first known neurotransmitter molecule, acetylcholine, was discovered jointly by Sir Henry Dale in England and by Otto Loewi in Germany. In 1921 Loewi was able to show that nerve endings transmit information to muscles by means of this substance. The idea for the critical experiment occurred to him in a dream at 3 am. Otto Loewi woke up and wrote down the idea; but in the morning he could not read what he had written. Luckily he had the same dream the following night. This time he took no chances. He got up, drank some coffee, and spent the whole night working in his laboratory. By morning he had shown that nerve cells separated from the muscle of a frog's heart secrete a chemical substance when stimulated, and that this substance is able to cause contractions of the heart of another frog. Sir Henry Dale later showed that Otto Loewi's transmitter molecule was identical to acetylcholine, which Dale had isolated from the ergot fungus in 1910. The two men shared a Nobel Prize in 1936. Since that time, a large variety of neurotransmitter

molecules have been isolated. Among the excitatory neurotransmitters (in addition to acetylcholine) are noradrenalin, norepinephrine, serotonin, dopamine, and glutamate, while gamma-amino-butyric acid is an example of an inhibitory neurotransmitter.

The mechanism by which electrical impulses propagate along nerve axons was clarified by the English physiologists Alan Lloyd Hodgkin and Andrew Fielding Huxley (a grandson of Darwin's defender, Thomas Henry Huxley). In 1952, working with the giant axon of the squid (which can be as large as a millimeter in diameter), they demonstrated that the electrical impulse propagating along a nerve is in no way similar to an electrical current in a conducting wire, but is more closely analogous to a row of dominoes knocking each other down. The nerve fiber, they showed, is like a long thin tube, within which there is a fluid containing K^+ , and Na^+ ions, as well as anions. Inside a resting nerve, the concentration of K^+ is higher than in the normal body fluids outside, and the concentration of Na^+ is lower. These abnormal concentrations are maintained by an "ion pump", which uses the Gibbs free energy of adenosine triphosphate (ATP) to bring potassium ions into the nerve and to expel sodium ions.

The membrane surrounding the neural axon is more permeable to potassium ions than to sodium, and the positively charged potassium ions tend to leak out of the resting nerve, producing a small difference in potential between the inside and outside. This "resting potential" helps to hold the molecules of the membrane in an orderly layer, so that the membrane's permeability to ions is low.

Hodgkin and Huxley showed that when a neuron fires, the whole situation changes dramatically. Triggered by the effects of excitatory neurotransmitter molecules, sodium ions begin to flow into the axon, destroying the electrical potential which maintained order in the membrane. A wave of depolarization passes along the axon. Like a row of dominoes falling, the disturbance propagates from one section to the next: Sodium ions flow in, the order-maintaining electrical potential disappears, the next small section of the nerve membrane becomes permeable, and so on. Thus, Hodgkin and Huxley showed that when a neuron fires, a quick pulse-like electrical and chemical disturbance is transmitted along the axon.

In 1953, Stephen W. Kuffler, working at Johns Hopkins University, made a series of discoveries which yielded much insight into the mechanisms by which the internuncial part of mammalian nervous systems processes information. Kuffler's studies showed that some degree of abstraction of patterns already takes place in the retina of the mammalian eye, before signals are passed on through the optic nerve to the visual cortex of the brain. In the mammalian retina, about 100 million light-sensitive primary light-receptor cells are con-

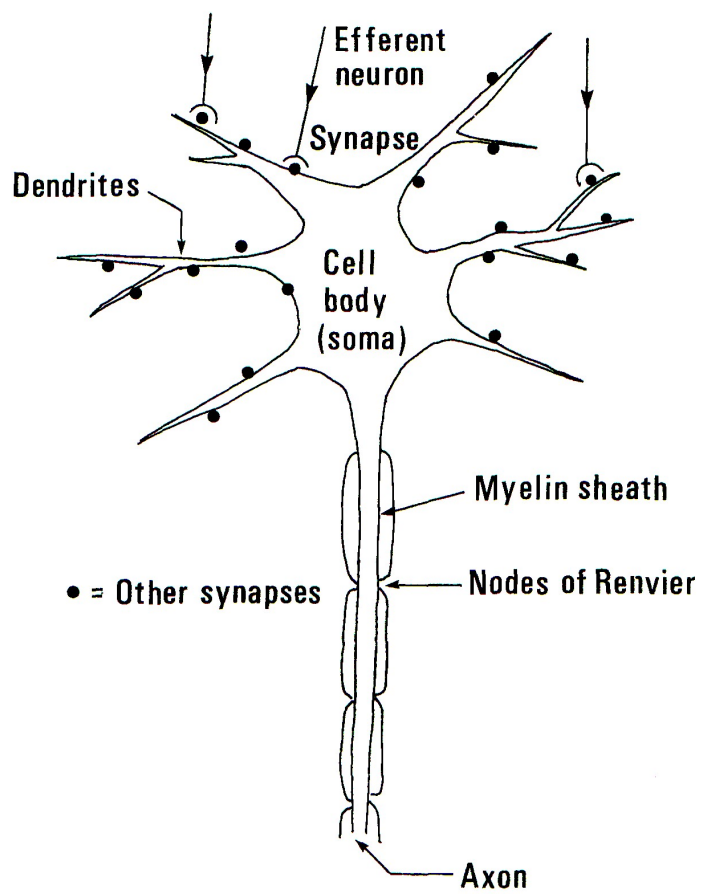

Figure 2.6: A schematic diagram of a neuron.

nected through bipolar neurons to approximately a million retinal neurons of another type, called ganglions. Kuffler's first discovery (made using micro-electrodes) was that even in total darkness, the retinal ganglions continue to fire steadily at the rate of about thirty pulses per second. He also found that diffuse light illuminating the entire retina does not change this steady rate of firing.

Kuffler's next discovery was that each ganglion is connected to an array of about 100 primary receptor cells, arranged in an inner circle surrounded by an outer ring. Kuffler found the arrays to be of two types, which he called "on center arrays" and "off center arrays". In the "on center arrays", a tiny spot of light, illuminating only the inner circle, produces a burst of frequent firing of the associated ganglion, provided that cells in the outer ring of the array remain in darkness. However, if the cells in the outer ring are also illuminated, there is a cancellation, and there is no net effect. Exactly the opposite proved to be the case for the "off center arrays". As before, uniform illumination of both the inner circle and outer ring of these arrays produces a cancellation and hence no net effect on the steady background rate of ganglion firing. However, if the central circle by itself is illuminated by a tiny spot of light, the ganglion firing is inhibited, whereas if the outer ring alone is illuminated, the firing is enhanced. Thus Kuffler found that both types of arrays give no response to uniform illumination, and that both types of arrays measure, in different ways, the degree of contrast in the light falling on closely neighboring regions of the retina.

Kuffler's research was continued by his two associates, David H. Hubel and Torsten N. Wiesel, at the Harvard Medical School, to which Kuffler had moved. In the late 1950's, they found that when the signals sent through the optic nerves reach the visual cortex of the brain, a further abstraction of patterns takes place through the arrangement of connections between two successive layers of neurons. Hubel and Wiesel called the cells in these two pattern-abstracting layers "simple" and "complex". The retinal ganglions were found to be connected to the "simple" neurons in such a way that a "simple" cell responds to a line of contrasting illumination of the retina. For such a cell to respond, the line has to be at a particular position and has to have a particular direction. However, the "complex" cells in the next layer were found to be connected to the "simple" cells in such a way that they respond to a line in a particular direction, even when it is displaced parallel to itself³.

³ Interestingly, at about the same time, the English physiologist J.Z. Young came to closely analogous conclusions regarding the mechanism of pattern abstraction in the visual cortex of the octopus brain. However, the similarity between the image-forming eye of the octopus and the image-forming vertebrate eye and the rough similarity between the mechanisms for pattern abstraction in the two cases must both be regarded as instances of

In analyzing their results, Kuffler, Hubel and Wessel concluded that pattern abstraction in the mammalian retina and visual cortex takes place through the selective destruction of information. This conclusion agrees with what we know in general about abstractions: They are always simpler than the thing which they represent.

Suggestions for further reading

1. H. Lodish, A. Berk, S.L. Zipursky, P. Matsudaira, D. Baltimore, and J. Darnell, *Molecular Cell Biology, 4th Edition*, W.H. Freeman, New York, (2000).
2. Lily Kay, *Who Wrote the Book of Life? A History of the Genetic Code*, Stanford University Press, Stanford CA, (2000).
3. Sahotra Sarkar (editor), *The Philosophy and History of Molecular Biology*, Kluwer Academic Publishers, Boston, (1996).
4. James D. Watson et al. *Molecular Biology of the Gene, 4th Edition*, Benjamin-Cummings, (1988).
5. J.S. Fruton, *Proteins, Enzymes, and Genes*, Yale University Press, New Haven, (1999).
6. S.E. Lauria, *Life, the Unfinished Experiment*, Charles Scribner's Sons, New York (1973).
7. A. Lwoff, *Biological Order*, MIT Press, Cambridge MA, (1962).
8. James D. Watson, *The Double Helix*, Athenium, New York (1968).
9. F. Crick, *The genetic code*, Scientific American, **202**, 66-74 (1962).
10. F. Crick, *Central dogma of molecular biology*, Nature, **227**, 561-563 (1970).
11. David Freifelder (editor), *Recombinant DNA, Readings from the Scientific American*, W.H. Freeman and Co. (1978).
12. James D. Watson, John Tooze and David T. Kurtz, *Recombinant DNA, A Short Course*, W.H. Freeman, New York (1983).
13. Richard Hutton, *Biorevolution, DNA and the Ethics of Man-Made Life*, The New American Library, New York (1968).
14. Martin Ebon, *The Cloning of Man*, The New American Library, New York (1978).
15. Sheldon Krinsky, *Genetic Alchemy: The Social History of the Recombinant DNA Controversy*, MIT Press, Cambridge Mass (1983).
16. M. Lappe, *Germs That Won't Die*, Anchor/Doubleday, Garden City N.Y. (1982).
17. M. Lappe, *Broken Code*, Sierra Club Books, San Francisco (1984).

convergent evolution, since the mollusc eye and the vertebrate eye have evolved independently.

18. President's Commission for the Study of Ethical Problems in Medicine and Biomedical and Behavioral Research, *Splicing Life: The Social and Ethical Issues of Genetic Engineering with Human Beings*, U.S. Government Printing Office, Washington D.C. (1982).
19. U.S. Congress, Office of Technology Assessment, *Impacts of Applied Genetics - Microorganisms, Plants and Animals*, U.S. Government Printing Office, Washington D.C. (1981).
20. W.T. Reich (editor), *Encyclopedia of Bioethics*, The Free Press, New York (1978).
21. Martin Brown (editor), *The Social Responsibility of the Scientist*, The Free Press, New York (1970).
22. B. Zimmerman, *Biofuture*, Plenum Press, New York (1984).
23. John Lear, *Recombinant DNA, The Untold Story*, Crown, New York (1978).
24. B. Alberts, D. Bray, J. Lewis, M. Raff, K. Roberts and J.D. Watson, *Molecular Biology of the Cell*, Garland, New York (1983).
25. C. Woese, *The Genetic Code; The Molecular Basis for Genetic Expression*, Harper and Row, New York, (1967).
26. F.H.C. Crick, *The Origin of the Genetic Code*, J. Mol. Biol. **38**, 367-379 (1968).
27. M.W. Niernberg, *The genetic code: II*, Scientific American, **208**, 80-94 (1962).
28. L.E. Orgel, *Evolution of the Genetic Apparatus*, J. Mol. Biol. **38**, 381-393 (1968).
29. Melvin Calvin, *Chemical Evolution Towards the Origin of Life, on Earth and Elsewhere*, Oxford University Press (1969).
30. R. Shapiro, *Origins: A Skeptic's Guide to the Origin of Life*, Summit Books, New York, (1986).
31. J. William Schopf, *Earth's earliest biosphere: its origin and evolution*, Princeton University Press, Princeton, N.J., (1983).
32. J. William Schopf (editor), *Major Events in the History of Life*, Jones and Bartlet, Boston, (1992).
33. Robert Rosen, *Life itself: a comprehensive inquiry into the nature, origin and fabrication of life*, Colombia University Press, (1991).
34. R.F. Gesteland, T.R Cech, and J.F. Atkins (editors), *The RNA World, 2nd Edition*, Cold Spring Harbor Laboratory Press, Cold Spring Harbor, New York, (1999).
35. C. de Duve, *Blueprint of a Cell*, Niel Patterson Publishers, Burlington N.C., (1991).
36. C. de Duve, *Vital Dust; Life as a Cosmic Imperative*, Basic Books, New York, (1995).

37. F. Dyson, *Origins of Life*, Cambridge University Press, (1985).
38. S.A. Kaufman, *Antichaos and adaption*, Scientific American, 265, 78-84, (1991).
39. S.A. Kauffman, *The Origins of Order*, Oxford University Press, (1993).
40. F.J. Varela and J.-P. Dupuy, *Understanding Origins: Contemporary Views on the Origin of Life, Mind and Society*, Kluwer, Dordrecht, (1992).
41. Stefan Bengtson (editor) *Early Life on Earth; Nobel Symposium No. 84*, Colombia University Press, New York, (1994).
42. Herrick Baltscheffsky, *Origin and Evolution of Biological Energy Conversion*, VCH Publishers, New York, (1996).
43. J. Chilea-Flores, T. Owen and F. Raulin (editors), *First Steps in the Origin of Life in the Universe*, Kluwer, Dordrecht, (2001).
44. R.E. Dickerson, Nature **283**, 210-212 (1980).
45. R.E. Dickerson, Scientific American **242**, 136-153 (1980).
46. C.R. Woese, *Archaeobacteria*, Scientific American **244**, 98-122 (1981).
47. N. Iwabe, K. Kuma, M. Hasegawa, S. Osawa and T. Miyata, *Evolutionary relationships of archaeobacteria, eubacteria, and eukaryotes inferred phylogenetic trees of duplicated genes*, Proc. Nat. Acad. Sci. USA **86**, 9355-9359 (1989).
48. C.R. Woese, O. Kandler, and M.L. Wheelis, *Towards a Natural System of Organisms: Proposal for the Domains Archaea, Bacteria and Eucaria*, Proc. Nat. Acad. Sci. USA **87**, 4576-4579 (1990).
49. W. Ford Doolittle, *Phylogenetic Classification and the Universal Tree*, Science, **284**, (1999).
50. G. Wächterhäuser, *Pyrite formation, the first energy source for life: A hypothesis*, Systematic and Applied Microbiology **10**, 207-210 (1988).
51. G. Wächterhäuser, *Before enzymes and templates: Theory of surface metabolism*, Microbiological Reviews, **52**, 452-484 (1988).
52. G. Wächterhäuser, *Evolution of the first metabolic cycles*, Proc. Nat. Acad. Sci. USA **87**, 200-204 (1990).
53. G. Wächterhäuser, *Groundworks for an evolutionary biochemistry the iron-sulfur world*, Progress in Biophysics and Molecular Biology **58**, 85-210 (1992).
54. M.J. Russell and A.J. Hall, *The emergence of life from iron monosulphide bubbles at a submarine hydrothermal redox and pH front* J. Geol. Soc. Lond. **154**, 377-402, (1997).
55. L.H. Caporale (editor), *Molecular Strategies in Biological Evolution*, Ann. N.Y. Acad. Sci., May 18, (1999).

56. W. Martin and M.J. Russell, *On the origins of cells: a hypothesis for the evolutionary transitions from abiotic geochemistry to chemoautotrophic prokaryotes, and from prokaryotes to nucleated cells*, Philos. Trans. R. Soc. Lond. B Biol. Sci., **358**, 59-85, (2003).
57. Werner Arber, *Elements in Microbial Evolution*, J. Mol. Evol. **33**, 4 (1991).
58. Michael Gray, *The Bacterial Ancestry of Plastids and Mitochondria*, BioScience, **33**, 693-699 (1983).
59. Michael Grey, *The Endosymbiont Hypothesis Revisited*, International Review of Cytology, **141**, 233-257 (1992).
60. Lynn Margulis and Dorian Sagan, *Microcosmos: Four Billion Years of Evolution from Our Microbial Ancestors*, Allan and Unwin, London, (1987).
61. Lynn Margulis and Rene Fester, eds., *Symbiosis as a Source of Evolutionary Innovation: Speciation and Morphogenesis*, MIT Press, (1991).
62. Charles Mann, *Lynn Margulis: Science's Unruly Earth Mother*, Science, **252**, 19 April, (1991).
63. Jan Sapp, *Evolution by Association; A History of Symbiosis*, Oxford University Press, (1994).
64. J.A. Shapiro, *Natural genetic engineering in evolution*, Genetics, **86**, 99-111 (1992).
65. E.M. De Robertis et al., *Homeobox genes and the vertebrate body plan*, Scientific American, July, (1990).
66. J.S. Schrum, T.F. Zhu and J.W. Szostak, *The origins of cellular life*, Cold Spring Harb. Perspect. Biol., May 19 (2010).
67. I. Budin and J.W. Szostak, *Expanding Roles for Diverse Physical Phenomena During the Origin of Life*, Annu. Rev. Biophys., **39**, 245-263, (2010).
68. M. Eigen et al., *The Origin of genetic information*, Scientific American, April, 78-94 (1981).
69. L.E. Kay, *Cybernetics, information, life: The emergence of scriptural representations of heredity*, Configurations, **5**, 23-91 (1997).
70. T.D. Schneider, G.D. Stormo, L. Gold and A. Ehrenfeucht, *Information content of binding sites on nucleotide sequences*, J. Mol. Biol. **88**, 415-431 (1986).
71. J. Avery, *A model for biological specificity*, Int. J. Quant. Chem., **26**, 843 (1984).
72. P.G. Mezey, *Shape in Chemistry: An Introduction to Molecular Shape and Topology*, VCH Publishers, New York, (1993).
73. P.G. Mezey, *Potential Energy Hypersurfaces*, Elsevier, Amsterdam, (1987).

74. P.G. Mezey, *Molecular Informatics and Topology in Chemistry, in Topology in Chemistry*, R.B. King and D.H. Rouvray, eds., Ellis Horwood, Pbl., U.K., (2002).
75. G. Stent, *Cellular communication*, Scientific American, **227**, 43-51 (1972).
76. A. Macieira-Coelho, editor, *Signaling Through the Cell Matrix*, Progress in Molecular and Subcellular Biology, **25**, Springer, (2000).
77. D.H. Hubel, *The visual cortex of the brain*, Scientific American, 209, 54, November, (1963).
78. G. Stent, editor, *Function and Formation of Neural Systems*.
79. J.Z. Young, *Programs of the Brain*, Oxford University Press, (1978).
80. J.Z. Young, *Philosophy and the Brain*, Oxford University Press, (1987).
81. K. von Frisch, *Dialects in the languages of bees*, Scientific American, August, (1962).
82. R.A. Hinde, *Non-Verbal Communication*, Cambridge University Press, (1972).
83. E.O. Wilson, *Animal communication*, Scientific American, **227**, 52-60 (1972).
84. E.O. Wilson, *Sociobiology*, Harvard University Press, (1975).
85. H.S. Terrace, L.A. Petitto, et al., *Can an ape create a sentence?*, Science, **206**, 891-902 (1979).
86. S. Savage-Rumbaugh, R. Lewin, et al., *Kanzi: The Ape at the Brink of the Human Mind*, John Wiley and Sons, New York, (1996).
87. R.W. Rutledge, B.L. Basore, and R.J. Mulholland, *Ecological stability: An information theory viewpoint*, J. Theor. Biol., **57**, 355-371 (1976).
88. L. Johnson, *Thermodynamics and ecosystems*, in *The Handbook of Environmental Chemistry*, O. Hutzinger, editor, Springer Verlag, Heidelberg, (1990), pp. 2-46.
89. C. Pahl-Wostl, *Information theoretical analysis of functional temporal and spatial organization in flow networks*, Math. Comp. Model. **16 (3)**, 35-52 (1992).
90. C. Pahl-Wostl, *The Dynamic Nature of Ecosystems: Chaos and Order Intertwined*, Wiley, New York, (1995).
91. E.D. Schneider and J.J. Kay, *Complexity and thermodynamics: Towards a new ecology*, Futures, **24 (6)**, 626-647 (1994).
92. R.E. Ulanowicz, *Ecology, the Ascendent Perspective*, Colombia University Press, New York, (1997).

Chapter 3

ANIMAL LANGUAGES

3.1 Communication of emotions

Communication between two or more multicellular organism often takes place through the medium of signal molecules, which are recognized by receptors. For example, the perfume of flowers is recognized by insects (and by us). Insect pheromones are among the most powerful signal molecules.

The language of ants depends predominantly on chemical signals. In most mammals too, the sense of smell plays a large role in mating, maternal behavior, and group organization¹. Anyone who has owned a pet cat or dog knows what an important role the sense of smell plays in their social lives.

Pheromones are defined as chemical compounds that are exchanged as signals between members of the same species, and very many of these substances have now been isolated and studied. Pheromones often play a role in reproduction. For example, females of the silkworm moth species *Bombyx mori* emit an alcohol, *trans*-10-*cis*-12-hexadecadienol, from a gland in tip of their their abdomens. The simplified name of this alcohol is “bombykol”, after the name of the moth. The male moth is equipped with feathery antennae, the hairs of which are sensitive to the pheromone - so sensitive in fact that a receptor on one of the hairs is able to register the presence of a single bombykol molecule! Aroused by even a very modest concentration of bombykol, the male finds himself compelled by the inherited programs of his brain to follow the path of increasing concentration until he finds the female and mates with her.

The pheromone *trans*-9-keto-2-decanoic acid, the “queen substance”, plays a somewhat more complex role in the social organization of the honeybee. This pheromone, which is emitted by the queen’s mandibular glands, has several functions. Workers lick the queen’s body and regurgitate the substance back

¹ Puppies up to the age of 7 weeks or so have a distinctive odor which is attractive to humans as well as to dogs.

and forth to each other, so that it is spread throughout the hive. When they do so, their ovaries fail to develop, and they are also restrained from raising larvae in such a way that the young bees could become queens. Thus, as long as the reigning queen is alive and producing the pheromone, she has no rivals. Another function of *trans*-9-keto-2-decanoic acid is to guide a husband to the queen on her nuptial flight and to promote the consummation of their marriage.

Worker bees cannot recognize each other as individuals, but each hive has a distinctive scent, shared by all its members. Foreign bees, with a different nest scent, are aggressively repelled. Like bees, their close relatives the ants also have a distinctive nest scent by which members of a colony recognize each other and repel foreigners.

Ants use chemical trails to guide each other to sources of food. An ant which has found an open jam jar marks the trail to it with a signalling substance, and other ants following this pheromone trail increase the intensity of the marking. However, the signal molecules continually evaporate. Eventually the trails disappear, and the ants are freed to explore other sources of food.

Bees guide each other to sources of food by another genetically programmed signaling method - the famous waggle dance, deciphered in 1945 by Karl von Frisch. When a worker bee has found a promising food source, she returns to the hive and performs a complex dance, the pattern of which indicates both the direction and distance of the food. The dancer moves repeatedly in a pattern resembling the Greek letter Θ . If the food-discoverer is able to perform her dance on a horizontal flat surface in view of the sun, the line in the center of the pattern points in the direction of the food. However, if the dance is performed in the interior of the hive on a vertical surface, gravity takes the place of the sun, and the angle between the central line and the vertical represents the angle between the food source and the sun.

The central part of the dance is, in a way, a re-enactment of the excited forager's flight to the food. As she traverses the central portion of the pattern, she buzzes her wings and waggles her abdomen rapidly, the number of waggles indicating the approximate distance to the food². After this central portion of the dance, she turns alternately to the left or to the right, following one or the other of the semicircles, and repeats the performance. Studies of the accuracy with which her hive-mates follow these instructions show that the waggle dance is able to convey approximately 7 bits of information - 3 bits concerning distance and 4 bits concerning direction. After making his initial discovery of the meaning of the dance, von Frisch studied the waggle dance in many species of bees. He was able to distinguish species-specific dialects, and

² The number of waggles is largest when the source of food is near, and for extremely nearby food, the bees use another dance, the "round dance"

to establish a plausible explanation for the evolution of the dance.

Like bees, most mammals have communication systems which utilize not only scent, but also other displays and signals. For example, galagos or bushbabies, small furry primates found in the rainforests of Africa, have scent glands on their faces, chests, arms, elbows, palms, and soles, and they also scent-mark their surroundings and each other with saliva and urine. In fact, galagos bathe themselves in urine, standing on one foot and using their hands and feet as cups. This scent-repertoire is used by the bushbabies to communicate reproductive and social information. However, in addition, they also communicate through a variety of calls. They croak, chirp, click, whistle and bark, and the mating call of the Greater Galago sounds exactly like the crying of a baby - whence the name.

The communication of animals (and humans) through visual displays was discussed by Charles Darwin in his book *The Expression of the Emotions in Man and Animals*. For example, he discussed the way in which the emotions of a dog are expressed as visual signs: "When a dog approaches a strange dog or man in a savage or hostile frame of mind", Darwin wrote, "he walks very stiffly; his head is slightly raised, or not much lowered; the tail is held erect and quite rigid; the hairs bristle, especially along the neck and back; the pricked ears are directed forwards, and the eyes have a fixed stare... Let it now be supposed that the dog suddenly discovers that the man he is approaching is not a stranger, but his master; and let it be observed how completely and instantaneously his whole bearing is reversed. Instead of walking upright, the body sinks downwards or even crouches, and is thrown into flexuous movements; the tail, instead of being held stiff and upright, is lowered and wagged from side to side; his hair instantly becomes smooth; his ears are depressed and drawn backwards, but not closely to the head, and his lips hang loosely. From the drawing back of the ears, the eyelids become elongated, and the eyes no longer appear round and staring."

A wide variety of animals express hostility by making themselves seem larger than they really are: Cats arch their backs, and the hairs on their necks and backs are involuntarily raised; birds ruffle their feathers and spread their wings; lizards raise their crests and lower their dewlaps; and even some species of fish show hostility by making themselves seem larger, by spreading their fins or extending their gill covers. Konrad Lorenz has noted, in his book *On Aggression*, that the "holy shiver" experienced by humans about to perform an heroic act in defense of their community is closely related to the bristling hair on the neck and back of a cat or dog when facing an enemy.

Human language has its roots in the nonverbal signs by which our evolutionary predecessors communicated, and traces of early human language can be seen in the laughter, tears, screams, groans, grins, winks, frowns, sneers,



Figure 3.1: A cat, confronting an enemy, arches its back. The hairs are also raised to make the cat seem larger and more threatening. Like the next few figures, this is one of the illustrations from Charles Darwin's book, *The Expression of Emotions in Man and Animals*.



Figure 3.2: A dog approaching an enemy in a hostile mood.



Figure 3.3: A man's face expressing terror.



Figure 3.4: An ape's face, expressing affection.

smiles, and explanatory gestures which we use even today to clarify and emphasize our words.

3.2 Pheromones

Communication between two or more multicellular organism often takes place through the medium of signal molecules, which are recognized by receptors. For example, the perfume of flowers is recognized by insects (and by us). Insect pheromones are among the most powerful signal molecules.

The language of ants depends predominantly on chemical signals. In most mammals too, the sense of smell plays a large role in mating, maternal behavior, and group organization³. Anyone who has owned a pet cat or dog knows what an important role the sense of smell plays in their social lives.

Pheromones are defined as chemical compounds that are exchanged as signals between members of the same species, and very many of these substances have now been isolated and studied. Pheromones often play a role in reproduction. For example, females of the silkworm moth species *Bombyx mori* emit

³ Puppies up to the age of 7 weeks or so have a distinctive odor which is attractive to humans as well as to dogs.

an alcohol, *trans*-10-*cis*-12-hexadecadienol, from a gland in tip of their their abdomens. The simplified name of this alcohol is “bombykol”, after the name of the moth. The male moth is equipped with feathery antennae, the hairs of which are sensitive to the pheromone - so sensitive in fact that a receptor on one of the hairs is able to register the presence of a single bombykol molecule! Aroused by even a very modest concentration of bombykol, the male finds himself compelled by the inherited programs of his brain to follow the path of increasing concentration until he finds the female and mates with her.

The pheromone *trans*-9-keto-2-decanoic acid, the “queen substance”, plays a somewhat more complex role in the social organization of the honeybee. This pheromone, which is emitted by the queen’s mandibular glands, has several functions. Workers lick the queen’s body and regurgitate the substance back and forth to each other, so that it is spread throughout the hive. When they do so, their ovaries fail to develop, and they are also restrained from raising larvae in such a way that the young bees could become queens. Thus, as long as the reigning queen is alive and producing the pheromone, she has no rivals. Another function of *trans*-9-keto-2-decanoic acid is to guide a husband to the queen on her nuptial flight and to promote the consummation of their marriage.

Worker bees cannot recognize each other as individuals, but each hive has a distinctive scent, shared by all its members. Foreign bees, with a different nest scent, are aggressively repelled. Like bees, their close relatives the ants also have a distinctive nest scent by which members of a colony recognize each other and repel foreigners.

Ants use chemical trails to guide each other to sources of food. An ant which has found an open jam jar marks the trail to it with a signalling substance, and other ants following this pheromone trail increase the intensity of the marking. However, the signal molecules continually evaporate. Eventually the trails disappear, and the ants are freed to explore other sources of food.

3.3 The waggle dance

Bees guide each other to sources of food by another genetically programmed signaling method - the famous waggle dance, deciphered in 1945 by Karl von Frisch. When a worker bee has found a promising food source, she returns to the hive and performs a complex dance, the pattern of which indicates both the direction and distance of the food. The dancer moves repeatedly in a pattern resembling the Greek letter Θ . If the food-discoverer is able to perform her dance on a horizontal flat surface in view of the sun, the line in the center of the pattern points in the direction of the food. However, if the dance is performed

in the interior of the hive on a vertical surface, gravity takes the place of the sun, and the angle between the central line and the vertical represents the angle between the food source and the sun.

The central part of the dance is, in a way, a re-enactment of the excited forager's flight to the food. As she traverses the central portion of the pattern, she buzzes her wings and waggles her abdomen rapidly, the number of waggles indicating the approximate distance to the food⁴. After this central portion of the dance, she turns alternately to the left or to the right, following one or the other of the semicircles, and repeats the performance. Studies of the accuracy with which her hive-mates follow these instructions show that the waggle dance is able to convey approximately 7 bits of information - 3 bits concerning distance and 4 bits concerning direction. After making his initial discovery of the meaning of the dance, von Frisch studied the waggle dance in many species of bees. He was able to distinguish species-specific dialects, and to establish a plausible explanation for the evolution of the dance.

3.4 Parrots and crows

Birds, especially members of the crow family, can have problem/solving abilities that are comparable to the most intelligent non-human animals, such as apes, elephants, dolphins and whales. An recent article by Edward Vajda states that:

“Bird calls consist of one or more short notes and seem to be instinctive responses to danger, nesting, flocking and a few other basic situations. The English sparrow has three flight calls - one used just before takeoff, another during flight, and one just before landing at a nesting site. Sparrows have two types of danger calls, one to announce that a predator is nearby - like an owl in a tree - and the other to announce that a predator is soaring overhead. These calls seem intended to coordinate group activity in specific situations. The meanings of these signs constitute a small, finite set which can't be increased. And bird calls cannot be varied to produce variations of meaning.

“Bird songs are used primarily by males to attract mates or establish territory. Bird songs are limited to these and only these functions. Although bird songs are longer than bird calls, their internal elements aren't separable into meaningful units and cannot be rearranged to produce new songs.

“Interestingly, although bird songs are inborn, and young birds naturally begin producing them at a certain age even if raised away from their species, the fledgling bird must experience adult songs to reproduce the song perfectly.

⁴ The number of waggles is largest when the source of food is near, and for extremely nearby food, the bees use another dance, the “round dance”



Figure 3.5: Crows and ravens are highly intelligent. Their problem-solving abilities are comparable to those of the most intelligent non-human animals, such as apes, elephants, whales and dolphins.



Figure 3.6: The Australian raven.

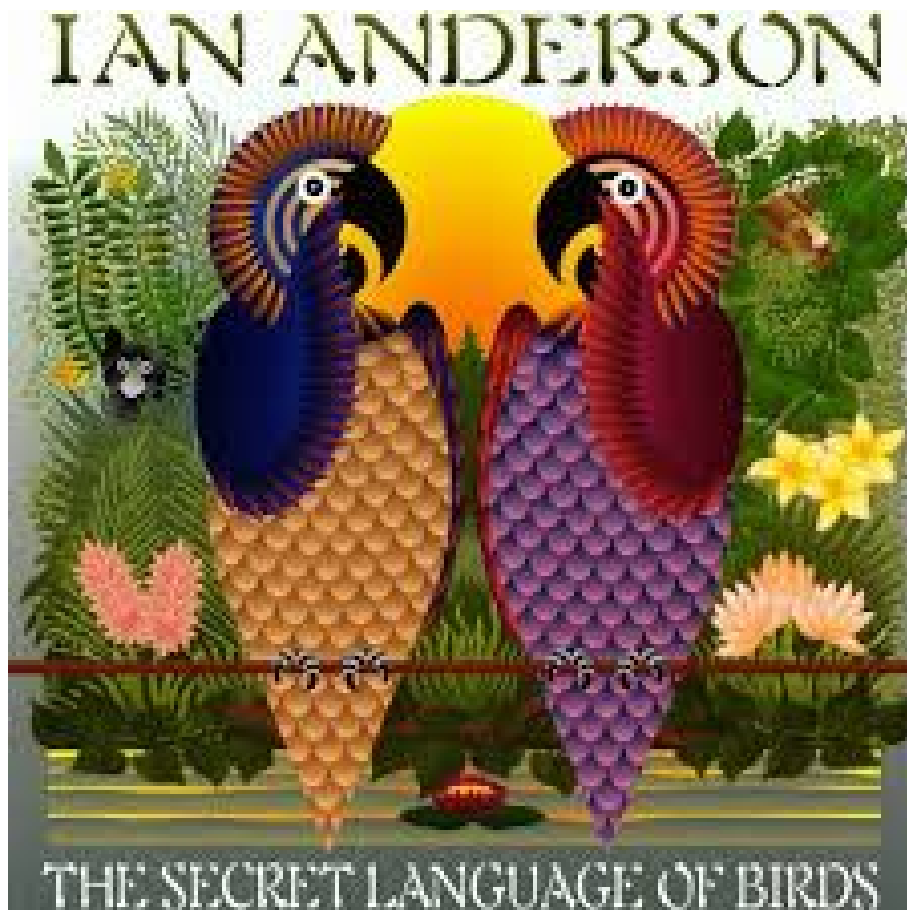

Figure 3.7: Although parrots can imitate many of the sounds of human speech, they certainly do not understand more than a tiny fraction of what they are able to say.

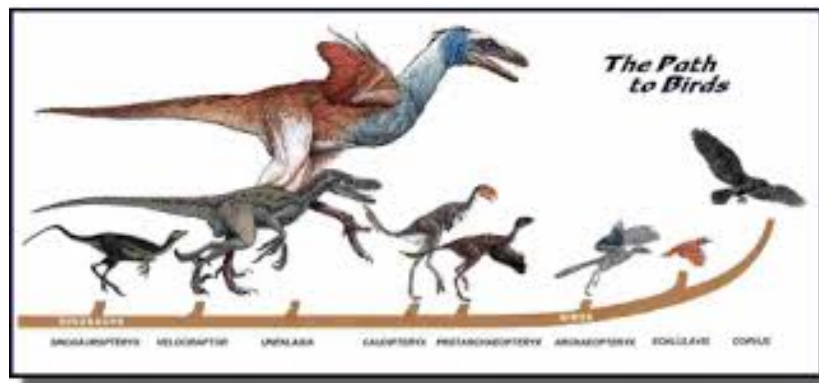

Figure 3.8: Birds may owe their problem-solving and communication abilities to their descent from dinosaurs.

If the fledgling is deprived of this input, it will grow up to produce the song naturally anyway, but with marked imperfections. ”

The relatively high intelligence of birds may be due to the fact that they have descended from the dinosaurs, which were capable of complex behavior, and which became extinct only 65 million years ago.

3.5 Bushbabies

Most mammals have communication systems which utilize not only scent, but also other displays and signals. For example, galagos or bushbabies, small furry primates found in the rainforests of Africa, have scent glands on their faces, chests, arms, elbows, palms, and soles, and they also scent-mark their surroundings and each other with saliva and urine. In fact, galagos bathe themselves in urine, standing on one foot and using their hands and feet as cups. This scent-repertoire is used by the bushbabies to communicate reproductive and social information. However, in addition, they also communicate through a variety of calls. They croak, chirp, click, whistle and bark, and the mating call of the Greater Galago sounds exactly like the crying of a baby - whence the name.

3.6 Washoe, Nim Chimpsky and Koko

The chimpanzee, Washoe, was the first ape to be taught sign language. Washoe (named after a county in Nevada) was taught American Sign Language by the husband and wife research team, Beatrix and Allen Gardner. The Gardners believed that previous efforts to teach language to apes had failed because the



Figure 3.9: Washoe, was the first ape to be taught sign language.

animals were anatomically unable to produce the appropriate sounds. Therefore in their research project at the University of Nevada, they tried to give Washoe an environment similar to that of a human baby with deaf parents. During all of Washoe's waking hours, there was always a researcher in attendance, and they all tried to communicate with her using American Sign Language (ASL). Ultimately (according to the Gardners) Washoe learned approximately 350 words of sign language.

The Wikipedia article on *Great ape language* states that “Linguistic critics challenged the animal trainers to demonstrate that Washoe was actually using language and not symbols. The null hypothesis was that the Gardners were using conditioning to teach the chimpanzee to use hand formations in certain contexts to create desirable outcomes, and that they had not learned the same linguistic rules that humans innately learn.

“In response to this challenge, the chimpanzee Nim Chimpsky (whose name is a play on linguist Noam Chomsky) was taught to communicate using sign language in studies led by Herbert S. Terrace. In 44 months, Nim Chimpsky learned 125 signs. However, linguistic analysis of Nim's communications demonstrated that Nim's use was symbolic, and lacked grammar, or rules, of the kind that humans use in communicating via language.

“Dr. Francine ‘Penny’ Patterson, a student of the Gardners, in 1972 began an ongoing program to teach ASL to a lowlands gorilla. Unlike the Gardners she did not limit her English speech around Koko, and as a result Koko understands approximately 1,000 ASL signs and 2,000 English words. Her results were similar to the Gardners' results with chimpanzees; although the gorilla learned a large number of signs she never understood grammar or symbolic speech, and hasn't displayed any cognition beyond that of a 2-3 year old human child.”



Figure 3.10: Nim Chimpski, (1973-2000), learning about eyes.



Figure 3.11: Koko and one of her friends.

Suggestions for further reading

1. M. Eigen et al., *The Origin of genetic information*, Scientific American, April, 78-94 (1981).
2. L.E. Kay, *Cybernetics, information, life: The emergence of scriptural representations of heredity*, Configurations, **5**, 23-91 (1997).
3. T.D. Schneider, G.D. Stormo, L. Gold and A. Ehrenfeucht, *Information content of binding sites on nucleotide sequences*, J. Mol. Biol. **88**, 415-431 (1986).
4. J. Avery, *A model for biological specificity*, Int. J. Quant. Chem., **26**, 843 (1984).
5. P.G. Mezey, *Shape in Chemistry: An Introduction to Molecular Shape and Topology*, VCH Publishers, New York, (1993).
6. P.G. Mezey, *Potential Energy Hypersurfaces*, Elsevier, Amsterdam, (1987).
7. P.G. Mezey, *Molecular Informatics and Topology in Chemistry*, in *Topology in Chemistry*, R.B. King and D.H. Rouvray, eds., Ellis Horwood, Pbl., U.K., (2002).
8. G. Stent, *Cellular communication*, Scientific American, **227**, 43-51 (1972).
9. A. Macieira-Coelho, editor, *Signaling Through the Cell Matrix*, Progress in Molecular and Subcellular Biology, **25**, Springer, (2000).
10. D.H. Hubel, *The visual cortex of the brain*, Scientific American, 209, 54, November, (1963).
11. G. Stent, editor, *Function and Formation of Neural Systems*.
12. J.Z. Young, *Programs of the Brain*, Oxford University Press, (1978).
13. J.Z. Young, *Philosophy and the Brain*, Oxford University Press, (1987).
14. K. von Frisch, *Dialects in the languages of bees*, Scientific American, August, (1962).
15. R.A. Hinde, *Non-Verbal Communication*, Cambridge University Press, (1972).
16. E.O. Wilson, *Animal communication*, Scientific American, **227**, 52-60 (1972).
17. E.O. Wilson, *Sociobiology*, Harvard University Press, (1975).
18. H.S. Terrace, L.A. Petitto, et al., *Can an ape create a sentence?*, Science, **206**, 891-902 (1979).
19. S. Savage-Rumbaugh, R. Lewin, et al., *Kanzi: The Ape at the Brink of the Human Mind*, John Wiley and Sons, New York, (1996).
20. R.W. Rutledge, B.L. Basore, and R.J. Mulholland, *Ecological stability: An information theory viewpoint*, J. Theor. Biol., **57**, 355-371 (1976).
21. L. Johnson, *Thermodynamics and ecosystems*, in *The Handbook of Environmental Chemistry*, O. Hutzinger, editor, Springer Verlag, Heidelberg, (1990), pp. 2-46.

22. C. Pahl-Wostl, *Information theoretical analysis of functional temporal and spatial organization in flow networks*, Math. Comp. Model. **16 (3)**, 35-52 (1992).
23. C. Pahl-Wostl, *The Dynamic Nature of Ecosystems: Chaos and Order Intertwined*, Wiley, New York, (1995).
24. E.D. Schneider and J.J. Kay, *Complexity and thermodynamics: Towards a new ecology*, Futures, **24 (6)**, 626-647 (1994).
25. R.E. Ulanowicz, *Ecology, the Ascendent Perspective*, Columbia University Press, New York, (1997).

Chapter 4

OUT OF AFRICA

4.1 Early ancestors of modern humans

In his *Systema Naturae*, published in 1735, Carolus Linnaeus correctly classified humans as mammals associated with the anthropoid apes. However, illustrations of possible ancestors of humans in a later book by Linnaeus, showed one with a manlike head on top of a long-haired body, and another with a tail. A century later, in 1856, light was thrown on human ancestry by the discovery of some remarkable bones in a limestone cave in the valley of Neander, near Düsseldorf - a skullcap and some associated long bones. The skullcap was clearly manlike, but the forehead was low and thick, with massive ridges over the eyes. The famous pathologist Rudolf Virchow dismissed the find as a relatively recent pathological idiot. Other authorities thought that it was “one of the Cossacks who came from Russia in 1814”. Darwin knew of the “Neanderthal man”, but he was too ill to travel to Germany and examine the bones. However, Thomas Huxley examined them, and in his 1873 book, *Zoological Evidences of Man’s Place in Nature*, he wrote: “Under whatever aspect we view this cranium... we meet with apelike characteristics, stamping it as the most pithecoïd (apelike) of human crania yet discovered.”

“In some older strata,” Huxley continued, “do the fossilized bones of an ape more anthropoid, or a man more pithecoïd, than any yet known await the researches of some unborn paleontologist?” Huxley’s question obsessed Eugene Dubois, a young Dutch physician, who reasoned that such a find would be most likely in Africa, the home of chimpanzees and gorillas, or in the East Indies, where orang-outangs live. He was therefore happy to be appointed to a post in Sumatra in 1887. While there, Dubois heard of a site in Java where the local people had discovered many ancient fossil bones, and at this site, after much searching, he uncovered a cranium which was much too low and flat to have belonged to a modern human. On the other hand it had features which

proved that it could not have belonged to an ape. Near the cranium, Dubois found a leg bone which clearly indicated upright locomotion, and which he (mistakenly) believed to belong to the same creature. In announcing his find in 1894, Dubois proposed the provocative name “*Pithecanthropus erectus*”, i.e. “upright-walking ape-man” Neand

Instead of being praised for this discovery, Dubois was denounced. His attackers included not only the clergy, but also many scientists (who had expected that an early ancestor of man would have an enlarged brain associated with an apelike body, rather than apelike head associated with upright locomotion). He patiently exhibited the fossil bones at scientific meetings throughout Europe, and gave full accounts of the details of the site where he had unearthed them. When the attacks nevertheless continued, Dubois became disheartened, and locked the fossils in a strongbox, out of public view, for the next 28 years. In 1923, however, he released a cast of the skull, which showed that the brain volume was about 900 cm³ - well above the range of apes, but below the 1200-1600 cm³ range which characterizes modern man. Thereafter he again began to exhibit the bones at scientific meetings.

The fossil bones of about 1000 hominids, intermediate between apes and humans, have now been discovered. The oldest remains have been found in Africa. Many of these were discovered by Raymond Dart and Robert Broom, who worked in South Africa, and by Louis and Mary Leaky and their son Richard, who made their discoveries at the Olduvai Gorge in Tanzania and at Lake Rudolph in Kenya. Table 6.1 shows some of the more important species and their approximate dates.

One can deduce from biochemical evidence that the most recent common ancestor of the anthropoid apes and of humans lived in Africa between 5 and 10 million years before the present. Although the community of palaeoanthropologists is by no means unanimous, there is reasonably general agreement that while *A. africanus* is probably an ancestor of *H. habilis* and of humans, the “robust” species, *A. aethiopicus*, *A. robustus* and *A. boisei*¹ represent a side-branch which finally died out. “*Pithecanthropus erectus*”, found by Dubois, is now classified as a variety of *Homo erectus*, as is “*Sinanthropus pekinensis*” (“Peking man”), discovered in 1929 near Beijing, China.

Footprints 3.7 million years old showing upright locomotion have been discovered near Laetoli in Tanzania. The Laetoli footprints are believed to have been made by *A. afarensis*, which was definitely bipedal, but upright locomotion is thought to have started much earlier. There is even indirect evidence which suggests that *A. ramidus* may have been bipedal. *Homo habilis*

¹ *A. boisei* was originally called “*Zinjanthropus boisei*” by Mary and Louis Leakey who discovered the fossil remains at the Olduvai Gorge. Charles Boise helped to finance the Leakey’s expedition.



Figure 4.1: Australopithecus afarensis lived between 3.9 and 2.9 million years ago, and walked upright. The most famous example of this homonid was given the name Lucy.



Figure 4.2: Homo erectus. Fossil evidence for this homonid starts 1.9 million years ago. Homo erectus left Africa and spread throughout Eurasia, as far as Georgia, Armenia, India, Sri Lanka, China and Indonesia.



Figure 4.3: *Homo sapiens neanderthalis*. Neanderthal man lived in Europe until about 30,000 years before the present and interbred with modern humans (*Homo sapiens sapiens*).

was discovered by Mary and Louis Leakey at the Olduvai Gorge, among beds of extremely numerous pebble tools. The Leakeys gave this name (meaning “handy man”) to their discovery in order to call special attention to his use of tools. The brain of *H. habilis* is more human than that of *A. africanus*, and in particular, the bulge of Broca’s area, essential for speech, can be seen on one of the skull casts. This makes it seem likely that *H. habilis* was capable of at least rudimentary speech.

Homo erectus was the first species of homonid to leave Africa, and his remains are found not only there, but also in Europe and Asia. “Peking man”, who belonged to this species, probably used fire. The stone tools of *H. erectus* were more advanced than those of *H. habilis*; and there is no sharp line of demarcation between the most evolved examples of *H. erectus* and early fossils of archaic *H. sapiens*.

Homo sapiens neanderthalensis lived side by side with *Homo sapiens sapiens* (modern man) for a hundred thousand years; but in relatively recent times, only 30,000 years ago, Neanderthal man disappeared. Did modern man out-compete him? Do present-day humans carry any Neanderthal genes? To what extent was modern man influenced by Neanderthal cultural achievements? Future research may tell us the answers to these questions, but for the moment they are mysteries.

The early ancestors of modern humans show an overall progression in various characteristics: Their body size and brain size grew. They began to mature more slowly and to live longer. Their tools and weapons increased in sophistication. Meanwhile their teeth became smaller, and their skeletons more gracile - less heavy in proportion to their size. What were the evolutionary forces which produced these changes? How were they rewarded by a better chance of survival?

Our ancestors moved from a forest habitat to the savannas of Africa. They changed from a vegetarian diet to an omnivorous one, becoming hunter-gatherers. The primate hand, evolved for grasping branches in a forest environment, found new uses. Branches and stones became weapons and tools - essential to hunters whose bodies lacked powerful claws and teeth. With a premium on skill in making tools, brain size increased. The beginnings of language helped to make hunts successful, and also helped in transmitting cultural skills, such as toolmaking and weaponmaking, from one generation to the next.

A modern human baby is almost entirely helpless. Compared with offspring of grazing animals, which are able to stand up and follow the herd immediately after birth, a human baby's development is almost ludicrously slow. However, there is nothing slow about the rate at which a young member of our species learns languages. Between the ages of one and four, young humans develop astonishing linguistic skills, far surpassing those of any other animal on earth. In the learning of languages by human children there is an interplay between genes and culture: The language learned is culturally determined, but the predisposition to learn some form of speech seems to be an inherited characteristic. For example, human babies of all nationalities have a tendency to "babble" - to produce random sounds. The sounds which they make are the same in all parts of the world, and they may include many sounds which are not used in the languages which the babies ultimately learn.

In his book, *Descent of Man* (John Murray, London, 1871) Charles Darwin wrote: "Man has an instinctive tendency to speak, as we see in the babble of young children, while no child has an instinctive tendency to bake, brew or write." Thus Darwin was aware of the genetic component of learning of speech by babies. When our ancestors began to evolve a complex language and culture, it marked the start of an entirely new phase in the evolution of life on earth.

4.2 Y-chromosomal DNA and mitochondrial DNA

Recent DNA studies have cast much light on human prehistory, and especially on the story of how a small group of anatomically and behaviorally modern humans left Africa and populated the remainder of the world. Two types of DNA have been especially useful - Y-chromosomal DNA and mitochondrial DNA.

When we reproduce, the man's sperm carries either an X chromosome or a Y chromosome. It is almost equally probable which of the two it carries. The waiting egg of the mother has an X chromosome with complete certainty. When the sperm and egg unite to form a fertilized egg and later an embryo, the YX combinations become boys while the XX combinations become girls. Thus every male human carries a Y chromosome inherited from his father, and in fact this chromosome exists in every cell of a male's body.

Humans have a total of 23 chromosomes, and most of these participate in what might be called the "genetic lottery" - part of the remaining 22 chromosomes come from the father, and part from the mother, and it is a matter of chance which parent contributes which chromosome. Because of this genetic lottery, no two humans are genetically the same, except in the case of identical twins. This diversity is a great advantage, not only because it provides natural selection variation on which to act, but also it because prevents parasites from mimicking our cell-surface antigens and thus outwitting our immune systems. In fact the two advantages of diversity just mentioned are so great that sexual reproduction is almost universal among higher animals and plants.

Because of its special role in determining the sex of offspring, the Y chromosome is exempted from participation in the genetic lottery. This makes it an especially interesting object of study because the only changes that occur in Y chromosomes as they are handed down between generations are mutations. These mutations are not only infrequent but they also happen at a calculable rate. Thus by studying Y-chromosomal lineages, researchers have been able not only to build up prehistoric family trees but also to assign dates to events associated with the lineages.

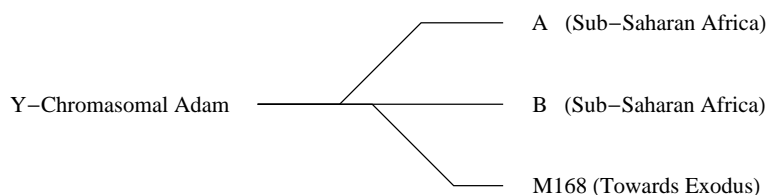

Figure 4.4: The mutation M168 seems to have occurred just before the ancestral population of anatomically and behaviorally modern humans left Africa, roughly 60,000 years ago. All of the men who left Africa at that time carried this mutation. The descendents of this small group, probably a single tribe, were destined to populate the entire world outside Africa.

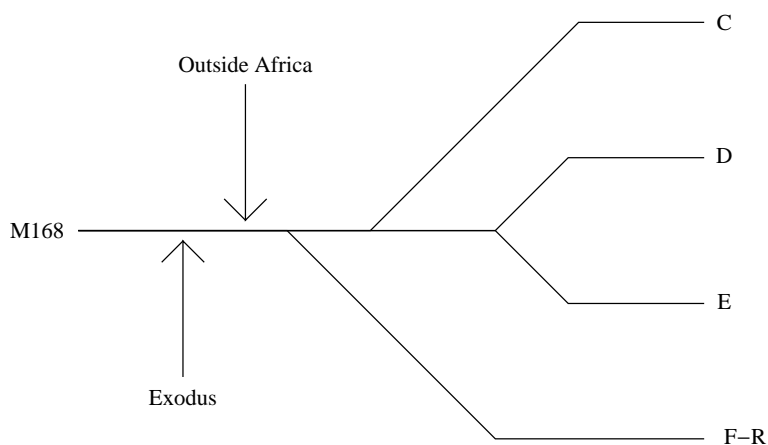

Figure 4.5: After M168, further mutations occurred, giving rise to the Y-chromosomal groups C, D, E and F-R. Men carrying Y chromosomes of type C migrated to Central Asia, East Asia and Australia/New Guinea. The D group settled in Central Asia, while men carrying Y chromosomes of type E can be found today in East Asia, Sub-Saharan Africa, the Middle East, West Eurasia, and Central Asia. Populations carrying Y chromosomes of types F-R migrated to all parts of the world outside Africa. Those members of population P who found their way to the Americas carried the mutation M242. Only indigenous men of the Americas have Y chromosomes with M242.

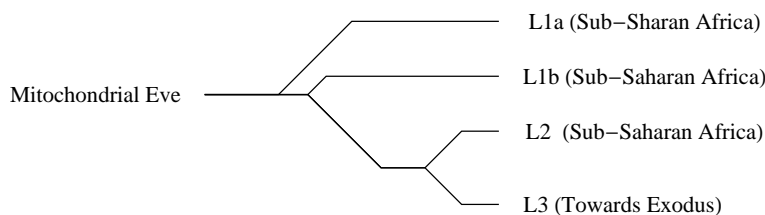

Figure 4.6: Mitochondrial DNA is present in the bodies of both men and women, but is handed on only from mother to daughter. The human family tree constructed from mutations in mitochondrial DNA is closely parallel to the tree constructed by studying Y chromosomes. In both trees we see that only a single small group left Africa, and that the descendents of this small group populated the remainder of the world. The mitochondrial groups L1a, L1b, and L2 are confined to Sub-Saharan Africa, but by following the lineage L3 we see a path leading out of Africa towards the population of the remainder of the world, as is shown in the next figure.

Mitochondrial DNA is also exempted from participation in the genetic lottery, but for a different reason. In Chapter 3 we mentioned that mitochondria were once free-living eubacteria of a type called alpha-proteobacteria. These free-living bacteria were able to perform oxidative phosphorylation, i.e. they could couple the combustion of glucose to the formation of the high-energy phosphate bond in ATP. When photosynthesis evolved, the earth's atmosphere became rich in oxygen, which was a deadly poison to most of the organisms alive at the time. Two billion years ago, when atmospheric oxygen began to increase in earnest, many organisms retreated into anaerobic ecological niches, while others became extinct; but some survived the oxygen crisis by incorporating alpha-proteobacteria into their cells and living with them symbiotically. Today, mitochondria living as endosymbionts in all animal cells, use oxygen constructively to couple the burning of food with the synthesis of ATP. As a relic of the time when they were free-living bacteria, mitochondria have their own DNA, which contained within them rather than within the cell nuclei.

When a sperm and an egg combine, the sperm's mitochondria are lost; and therefore all of the mitochondria in the body of a human child come from his or her mother. Just as Y-chromosomal DNA is passed essentially unchanged between generations in the male lines of a family tree, mitochondrial DNA is passed on almost without change in the female lines. The only changes in both cases are small and infrequent mutations. By estimating the frequency of these mutations, researchers can assign approximate dates to events in human prehistory.

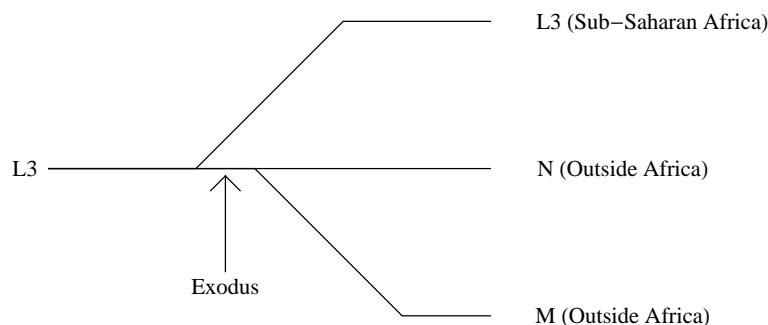

Figure 4.7: While the unmutated L3 lineage remained in Africa, a slightly changed group of people found their way out. It seems to have been a surprisingly small group, perhaps only a single tribe. Their descendents populated the remainder of the the world. The branching between the N and M lineages occurred after their exodus from Africa. All women in Western Eurasia are daughters of the N line, while in Eastern Eurasia women are descended from both the N and M lineages. Daughters of both N and M reached the Americas.

Mitochondrial Eve and Y-Chromosomal Adam

On the female side of the human family tree, all lines lead back to a single woman, whom we might call “Mitochondrial Eve”. Similarly, all the lines of the male family tree lead back to a single man, to whom we can give the name “Y-Chromosomal Adam”. (“Eve” and “Adam” were not married, however; they were not even contemporaries!)

But why do the female and male and family trees both lead back to single individuals? This has to do with a phenomenon called “genetic drift”. Sometimes a man will have no sons, and in that case, his male line will end, thus reducing the total number of Y-chromosomes in the population. Finally, after many generations, all Y-chromosomes will have dropped away through the ending of male lines except those that can be traced back to a single individual. Similar considerations hold for female lines.

When did Y-Chromosomal Adam walk the earth? Peter Underhill and his colleagues at Stanford University calculate that, on the basis of DNA evidence, Adam lived between 40,000 and 140,000 years before the present (BP). However, on the basis of other evidence (for example the dating of archaeological sites in Australia) 40,000 years BP can be ruled out as being much too recent. Similar calculations on the date of Mitochondrial Eve find that she lived very approximately 150,000 years BP, but again there is a wide error range.

Table 4.1: **Events leading up to the dispersal of fully modern humans from Africa (a model proposed by Sir Paul Mellars).**

Years before present	Event
150,000-200,000 BP	Initial emergence of anatomically modern populations in Africa
110,000-90,000 BP	Temporary dispersal of anatomically modern populations (with Middle Paleolithic technology) from Africa to southwest Asia, associated with clear symbolic expression
80,000-70,000 BP	Rapid climatic and environmental changes in Africa
80,000-70,000 BP	Major technological, economic and social changes in south and east Africa
70,000-60,000 BP	Major population expansion in Africa from small source area
ca. 60,000 BP	Dispersal of modern populations from Africa to Eurasia



Figure 4.8: A 2014 photograph of Prof. Dr. Svante Pääbo, one of the founders of paleogenetics. In 1997, Pääbo and his colleagues at the Max Planck Institute for Evolutionary Anthropology reported their successful sequencing of Neanderthal mitochondrial DNA. Later they sequenced the DNA of Denisovans, the eastern cousins of the Neanderthals. They were also able to show that 3-5% of the DNA of humans living outside Africa is shared with Neanderthals and Denisovans, indicating intermarriage.

4.3 Exodus: Out of Africa

A model for the events leading up to the exodus of fully modern humans from Africa has been proposed by Sir Paul Mellars of Cambridge University, and it is shown in Table 6.3. In the article on which this table is based, Mellars calls our attention to archaeological remains of anatomically modern humans at the sites of Skhul and Qafzeh in what is now northern Israel. The burials have been dated as having taken place 110,000-90,000 BP, and they show signs of cultural development, including ceremonial arrangement with arms folded, and sacrificial objects such as pierced shell ornaments. This early exodus was short-lived, however, probably because of competition with the long-established Neanderthal populations in the region.

In Mellars' model, rapid climatic and environmental changes took place in Africa during the period 80,000-70,000 BP. According to the Toba Catastrophe Theory² the climatic changes in Mellars' model were due to the eruption of a supervolcano at the site of what is now Lake Toba in Indonesia. This eruption, one of the largest known to us, took place ca. 73,000 BP, and plunged the earth into a decade of extreme cold, during which the population of our direct ancestors seem to have been reduced to a small number, perhaps as few as 10,000 individuals³.

The survivors of the Toba Catastrophe may have been selected for improved linguistic ability, which gave them a more advanced culture than their contemporaries. Mellars points to archaeological and genetic evidence that a major population expansion of the L2 and L3 mitochondrial lineages took place in Africa 70,000-60,000 BP, starting from a small source region in East Africa, and spreading west and south. The expanding L2 and L3 populations were characterized by advanced cultural features such as upper paleolithic technology, painting and body ornaments.

All researchers agree that it was a small group of the L3 mitochondrial lineage that made the exodus from Africa, but there is some disagreement about the date of this event. These differences reflect the intrinsic inaccuracy of the genetic dating methods, but all researchers agree that the group passing out of Africa was remarkably small, especially when we reflect that the entire population of the remainder of the world is descended from them.

The small group of modern humans leaving Africa probably crossed the Red

²The Toba Catastrophe Theory is supported by such authors as Ann Gibbons, Michael R. Rampino and Steven Self

³Additional support to the Toba Catastrophe Theory comes from DNA studies of mammals, such as chimpanzees, orangutans, macques, cheetahs, tigers and gorillas. These mammals also seem, on the basis of DNA studies, to have been reduced to very small populations at the time of the Toba eruption.

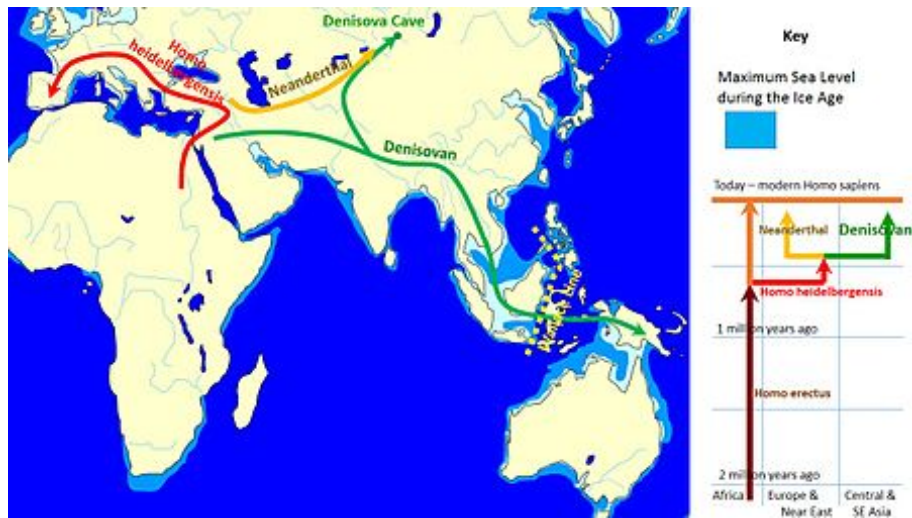

Figure 4.9: Spread and evolution of the Denisovans

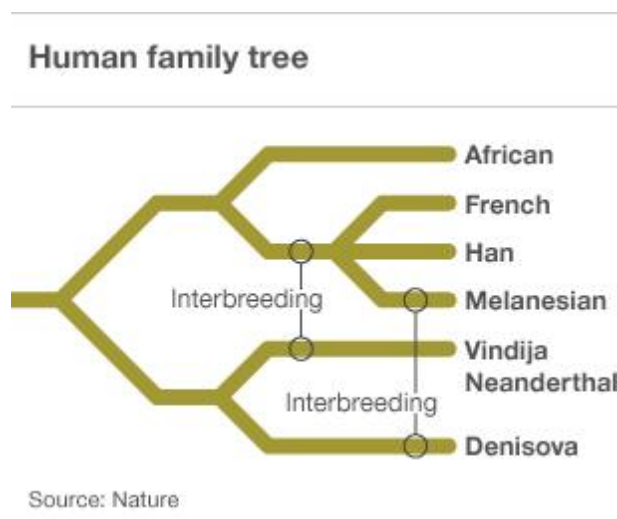

Figure 4.10:

Sea at its narrowest point⁴. The men in this tiny but brave group of explorers carried with them the Y-chromosomal mutation M168, while the women were of the mitochondrial lineage L3. Shortly after they crossed the Red Sea (like Moses and his followers), a mutation occurred and two new mitochondrial lineages were established, M and N. All women today in Western Eurasia are daughters of the N lineage⁵, while the M lineage spread to the entire world outside Africa. The mitochondrial lineages M and N had further branches, and daughters of the A, B, C, D and X lineages passed over a land bridge which linked Siberia to Alaska during the period 22,000-7,000 BP, thus reaching the Americas.

4.4 Joseph Greenberg's classification of languages and DNA analysis

In his excellent and fascinating book *Before the Dawn*, the science journalist Nicholas Wade discusses linguistic studies that support the early human migration scenarios that can be deduced from DNA research. The work of the unconventional but visionary linguist Joseph Greenberg of Stanford University is particularly interesting.

While other linguists were content to demonstrate relationships between a few languages, such as those in the Indo-European family, Greenberg attempted to arrange all known languages into an enormous family tree. He

⁴Today this narrow place is sometimes called "Gate of Grief" because many shipwrecks take place there.

⁵Of course, this broad statement does not take into account the movements of peoples that have taken place during historic times.



Figure 4.11: A photograph of the great but controversial linguist Joseph Greenberg (1915-2001). After his death, his visionary studies were vindicated by DNA-based human migration scenarios, which agreed in surprising detail with Greenberg's linguistically-based story of how early humans left their ancestral homeland in Africa and populated the entire earth.

published this work in the 1950's, long before the DNA studies that we have just been discussing, and because of what other linguists regarded as lack of rigor in his methods, Greenberg's prophetic voice was largely ignored by his peers. The linguist Paul Newman recalls visiting the London School of Oriental and African Studies ca. 1970. He was told that he could use the Common Room as long as he promised never to mention the name of Joseph Greenberg.

Finally, after Joseph Greenberg's death, his visionary studies were vindicated by DNA-based human migration scenarios, which agreed in surprising detail with the great but neglected scholar's linguistically-based story of how early humans left their ancestral homeland in Africa and populated the entire earth.

The Wikipedia article on Joseph Greenberg states that "Greenberg's reputation rests partly on his contributions to synchronic linguistics and the quest to identify linguistic universals. During the late 1950s, Greenberg began to examine languages covering a wide geographic and genetic distribution. He located a number of interesting potential universals as well as many strong cross-linguistic tendencies.

"In particular, Greenberg conceptualized the idea of 'implicational universal', which has the form, 'if a language has structure X, then it must also have structure Y.' For example, X might be 'mid front rounded vowels' and Y 'high front rounded vowels' (for terminology see phonetics). Many scholars adopted this kind of research following Greenberg's example and it remains important in synchronic linguistics.

"Like Noam Chomsky, Greenberg sought to discover the universal structures on which human language is based. Unlike Chomsky, Greenberg's method was functionalist, rather than formalist. An argument to reconcile the Greenbergian and Chomskyan methods can be found in *Linguistic Universals* (2006), edited by Ricardo Mairal and Juana Gil ."

Suggestions for further reading

1. Mairal. Ricardo and Juana Gil, (2006), *Linguistic Universals*, Cambridge University Press.
2. Chafe, Wallace. (1987). [Review of Greenberg 1987]. *Current Anthropology*, 28, 652-653.
3. Goddard, Ives. (1987). [Review of Joseph Greenberg, *Language in the Americas*]. *Current Anthropology*, 28, 656-657.
4. Goddard, Ives. (1990). [Review of *Language in the Americas* by Joseph H. Greenberg]. *Linguistics*, 28, 556-558.
5. Golla, Victor. (1988). [Review of *Language in the Americas*, by Joseph Greenberg]. *American Anthropologist*, 90, 434-435.

6. Kimball, Geoffrey. (1992). A critique of Muskogean, 'Gulf,' and Yukian materials in *Language in the Americas*. *International Journal of American Linguistics*, 58, 447-501.
7. Poser, William J. (1992). The Salinan and YurumanguÃ data in *Language in the Americas*. *International Journal of American Linguistics*, 58 (2), 202-229. PDF
8. D.R. Griffin, *Animal Mind - Human Mind*, Dahlem Conferenzen 1982, Springer, Berlin, (1982).
9. S. Savage-Rumbaugh, R. Lewin, et al., *Kanzi: The Ape at the Brink of the Human Mind*, John Wiley and Sons, New York, (1996).
10. R. Dunbar, *Grooming, Gossip, and the Evolution of Language*, Harvard University Press, (1998).
11. J.H. Greenberg, *Research on language universals*, *Annual Review of Anthropology*, 4, 75-94 (1975).
12. M.E. Bitterman, *The evolution of intelligence*, *Scientific American*, January, (1965).
13. R. Fox, *In the beginning: Aspects of hominid behavioral evolution*, *Man*, NS 2, 415-433 (1967).
14. M.S. Gazzaniga, *The split brain in man*, *Scientific American*, 217, 24-29 (1967).
15. D. Kimura, *The asymmetry of the human brain*, *Scientific American*, 228, 70-78 (1973).
16. R.G. Klein, *Anatomy, behavior, and modern human origins*, *Journal of World Prehistory*, 9 (2), 167-198 (1995).
17. N.G. Jablonski and L.C. Aiello, editors, *The Origin and Diversification of Language*, *Wattis Symposium Series in Anthropology*. *Mem- oirs of the California Academy of Sciences*, No. 24, The California Academy of Sciences, San Francisco, (1998).
18. S. Pinker, *The Language Instinct: How the Mind Creates Language*, Harper-Collins Publishers, New York, (1995).
19. J.H. Barkow, L. Cosmides and J. Tooby, editors, *The Adapted Mind: Evolutionary Psychology and the Generation of Culture*, Oxford Uni- versity Press, (1995).
20. D.R. Begun, C.V. Ward and M.D. Rose, *Function, Phylogeny and Fossils: Miocene Hominid Evolution and Adaptations*, Plenum Press, New York, (1997).
21. R.W. Byrne and A.W. Whitten, *Machiavellian Intelligence: Social Ex- pertise and the Evolution of Intellect in Monkeys, Apes and Humans*, Cambridge University Press, (1988),
22. V.P. Clark, P.A. Escholz and A.F. Rosa, editors, *Language: Readings in Language and Culture*, St Martin's Press, New York, (1997).

23. T.W. Deacon, *The Symbolic Species: The Co-evolution of Language and the Brain*, W.W. Norton and Company, New York, (1997).
24. C. Gamble, *Timewalkers: The Prehistory of Global Colonization*, Harvard University Press, (1994).
25. K.R. Gibson and T. Ingold, editors, *Tools, Language and Cognition in Human Evolution*, Cambridge University Press, (1993).
26. P. Mellers, *The Emergence of Modern Humans: An Archeological Perspective*, Edinburgh University Press, (1990).
27. P. Mellers, *The Neanderthal Legacy: An Archeological Perspective of Western Europe*, Princeton University Press, (1996).
28. S. Mithen, *The Prehistory of the Mind*, Thames and Hudson, London, (1996).
29. D. Haraway, *Signs of dominance: from a physiology to a cybernetics, of primate biology*, C.R. Carpenter, 1939-1970, *Studies in History of Biology*, **6**, 129-219 (1983).
30. D. Johanson and M. Edey, *Lucy: The Beginnings of Humankind*, Simon and Schuster, New York, (1981).
31. B. Kurten, *Our Earliest Ancestors*, Columbia University Press, New York, (1992).
32. R. Lass, *Historical Linguistics and Language Change*, Cambridge University Press, (1997).
33. R.E. Leakey and R. Lewin, *Origins Reconsidered*, Doubleday, New York, (1992).
34. P. Lieberman, *The Biology and Evolution of Language*, Harvard University Press, (1984).
35. C.S.L. Lai, S.E. Fisher, J.A. Hurst, F. Vargha-Khadem, and A.P. Monaco, *A forkhead-domain gene is mutated in a severe speech and language disorder*, *Nature*, **413**, 519-523, (2001).
36. W. Enard, M. Przeworski, S.E. Fisher, C.S.L. Lai, V. Wiebe, T. Kitano, A.P. Monaco, and S. Paabo, *Molecular evolution of FOXP2, a gene involved in speech and language*, *Nature AOP*, published online 14 August 2002.
37. M. Gopnik and M.B. Crago, *Familial aggregation of a developmental language disorder*, *Cognition*, **39**, 1-50 (1991).
38. K.E. Watkins, N.F. Dronkers, and F. Vargha-Khadem, *Behavioural analysis of an inherited speech and language disorder. Comparison with acquired aphasia*, *Brain*, **125**, 452-464 (2002).
39. J.D. Wall and M. Przeworski, *When did the human population size start increasing?*, *Genetics*, **155**, 1865-1874 (2000).
40. L. Aiello and C. Dean, *An Introduction to Human Evolutionary Anatomy*, Academic Press, London, (1990).

41. F. Ikawa-Smith, ed., *Early Paleolithic in South and East Asia*, Mouton, The Hague, (1978).
42. M. Aitken, *Science Based Dating in Archeology*, Longman, London, (1990).
43. R.R. Baker, *Migration: Paths Through Space and Time*, Hodder and Stoughton, London, (1982).
44. P. Bellwood, *Prehistory of the Indo-Malaysian Archipelago*, Academic Press, Sidney, (1985).
45. P.J. Bowler, *Theories of Human Evolution: A Century of Debate, 1884-1944*, Basil Blackwell, Oxford, (1986).
46. G. Isaac and M. McCown, eds., *Human Origins: Louis Leaky and the East African Evidence*, Benjamin, Menlo Park, (1976).
47. F.J. Brown, R. Leaky, and A. Walker, *Early Homo erectus skeleton from west Lake Turkana, Kenya*, *Nature*, **316**, 788-92 (1985).
48. K.W. Butzer, *Archeology as Human Ecology*, Cambridge University Press, (1982).
49. A.T. Chamberlain and B.A. Wood, *Early hominid phylogeny*, *Journal of Human Evolution*, **16**, 119-33, (1987).
50. P. Mellars and C. Stringer, eds., *The Human Revolution: Behavioural and Biological Perspectives in the Origins of Modern Humans*, Edinburgh University Press, (1989).
51. G.C. Conroy, *Primate Evolution*, W.W. Norton, New York, (1990).
52. R.I.M. Dunbar, *Primate Social Systems*, Croom Helm, London, (1988).
53. B. Fagan, *The Great Journey: The Peopling of Ancient America*, Thames and Hudson, London, (1987).
54. R.A. Foley, ed., *Hominid Evolution and Community Ecology*, Academic Press, New York, (1984).
55. S.R. Binford and L.R. Binford, *Stone tools and human behavior*, *Scientific American*, **220**, 70-84, (1969).
56. G. Klein, *The Human Career, Human Biological and Cultural Origins*, University of Chicago Press, (1989).
57. B.F. Skinner and N. Chomsky, *Verbal behavior*, *Language*, **35**, 26-58 (1959).
58. D. Bickerton, *The Roots of Language*, Karoma, Ann Arbor, Mich., (1981).
59. E. Lenneberg in *The Structure of Language: Readings in the Philosophy of Language*, J.A. Fodor and J.A. Katz editors, Prentice-Hall, Englewood Cliffs N.J., (1964).
60. S. Pinker, *Talk of genetics and visa versa*, *Nature*, **413**, 465-466, (2001).
61. S. Pinker, *Words and rules in the human brain*, *Nature*, **387**, 547-548, (1997).
62. M. Ruhelen, *The Origin of Language*, Wiley, New York, (1994).

63. C.B. Stringer and R. McKie, *African Exodus: The Origins of Modern Humanity*, Johnathan Cape, London (1996).
64. R. Lee and I. DeVore, editors, *Kalahari Hunter-Gatherers*, Harvard University Press, (1975).
65. R.W. Sussman, *The Biological Basis of Human Behavior*, Prentice Hall, Englewood Cliffs, (1997).
66. D. Schmand-Besserat, *Before Writing, Volume 1, From Counting to Cuneiform*, University of Texas Press, Austin, (1992).
67. D. Schmandt-Besserat, *How Writing Came About*, University of Texas Press, Austin, (1992).
68. A. Robinson, *The Story of Writing*, Thames, London, (1995).
69. A. Robinson, *Lost Languages: The Enigma of the World's Great Undeciphered Scripts*, McGraw-Hill, (2002).
70. D. Jackson, *The Story of Writing*, Taplinger, New York, (1981).
71. G. Jeans, *Writing: The Story of Alphabets and Scripts*, Abrams and Thames, (1992).
72. W.M. Senner, editor, *The Origins of Writing*, University of Nebraska Press, Lincoln and London, (1989).
73. F. Coulmas, *The Writing Systems of the World*, Blackwell, Oxford, (1989).
74. F. Coulmas, *The Blackwell Encyclopedia of Writing Systems*, Blackwell, Oxford, (1996).
75. P.T. Daniels and W. Bright, editors, *The World's Writing Systems*, Oxford University Press, (1996).
76. H.J. Nissen, *The Early History of the Ancient Near East, 9000-2000 B.C.*, University of Chicago Press, (1988).
77. H.J. Nissen, *Archaic Bookkeeping: Early Writing and Techniques of Economic Administration in the Ancient Near East*, University of Chicago Press, (1993).
78. J. Bottero, *Ancient Mesopotamia: Everyday Life in the First Civilization*, Edinburgh University Press, (2001).
79. J. Bottero, *Mesopotamia: Writing, Reasoning and the Gods*, University of Chicago Press, (1992).
80. J.T. Hooker, *Reading the Past: Ancient Writing, from Cuneiform to the Alphabet*, University of California Press, Berkeley and Los Angeles, (1990).
81. W.A. Fairservis, Jr., *The Script of the Indus Valley*, Scientific American, March (1983), 41-49.
82. C.H. Gordon, *Forgotten Scripts: Their Ongoing Discovery and Decipherment*, Dorset Press, New York, (1992).

83. G. Ferraro, *Cultural Anthhropology, 3rd Edition*, Wadsworth, Belmont CA, (1998).
84. R. David, *Handbook to Life in Ancient Egypt*, Facts on File, New York, (1998).
85. D. Sandison, *The Art of Egyptian Hieroglyphs*, Reed, London, (1997).
86. K.T. Zauzich, *Hieroglyphs Without Mystery*, University of Texas Press, Austin, (1992).
87. B. Watterson, *Introducing Egyptian Hieroglyphs*, Scottish Academic Press, Edinburgh, (1981).
88. M. Pope, *The Story of Decipherment, from Egyptian Hieroglyphs to Maya Script*, Thames and Hudson, London, (1999).
89. M.D. Coe, *Breaking the Maya Script*, Thames and Hudson, New York, (1992).
90. M.D. Coe, *The Maya, 5th Edition*, Thames and Hudson, New York, (1993).
91. M.D. Coe, *Mexico: From the Olmecs to the Aztecs, 4th Edition*, Thames and Hudson, New York, (1994).
92. D. Preidel, L. Schele and J. Parker, *Maya Cosmos: Three Thousand Years on the Shaman's Path*, William Morrow, New York, (1993).
93. W.G. Bolz, *The Origin and Early Development of the Chinese Writing System*, American Oriental Society, New Haven Conn., (1994).
94. T.F. Carter, *The Invention of Printing in China and its Spread Westward*, Ronald Press, (1925).
95. E. Eisenstein, *The Printing Revolution in Early Modern Europe*, Cambridge University Press, (1983).
96. M. Olmert, *The Smithsonian Book of Books*, Wing Books, New York, (1992).

Chapter 5

PATHFINDING

5.1 The 2014 Nobel Prize in Medicine and Physiology

Some excerpts from Edvard L. Moser's Nobel lecture

All three 2014 Nobel Prize winners in Physiology or Medicine stand on the shoulders of E.C. Tolman. Based on experiments on rats running in various types of mazes, Tolman suggested from the 1930s to the 1950s that animals form internal maps of the external environment. He referred to such maps as cognitive maps and considered them as mental knowledge structures in which information was stored according to its position in the environment (Tolman, 1948). In this sense, Tolman was not only one of the first cognitive psychologists but he also directly set the stage for studies of how space is represented in the brain. Tolman himself avoided any reference to neural structures and neural activity in his theories, which was understandable at a time when neither concepts nor methods had been developed for investigations at the brain-behaviour interface. However, at the end of his life he expressed strong hopes for a neuroscience of behaviour. In 1958, after the death of Lashley, he wrote the following in a letter to Donald O. Hebb when Hebb asked him about his view of physiological explanations of behaviour in the early days of behaviourism: "I certainly was an anti-physiologist at that time and am glad to be considered as one then. Today, however, I believe that this ('physiologising') is where the great new break-throughs are coming."

The psychology-physiology boundary was broken from the other side by two pioneers of physiology, David Hubel and Torsten Wiesel, who in the late 1950s bravely started to record activity from single neurons in the cortex, the origin of most of our intellectual activity. Inserting electrodes into the primary visual cortex of awake animals, they discovered how activity of individual neurons



Figure 5.1: The three winners of the 2014 Nobel Prize in Physiology or Medicine



Figure 5.2: Edward Chace Tolman (1886-1959). He founded a branch of psychology known as *perposive behaviourism*.

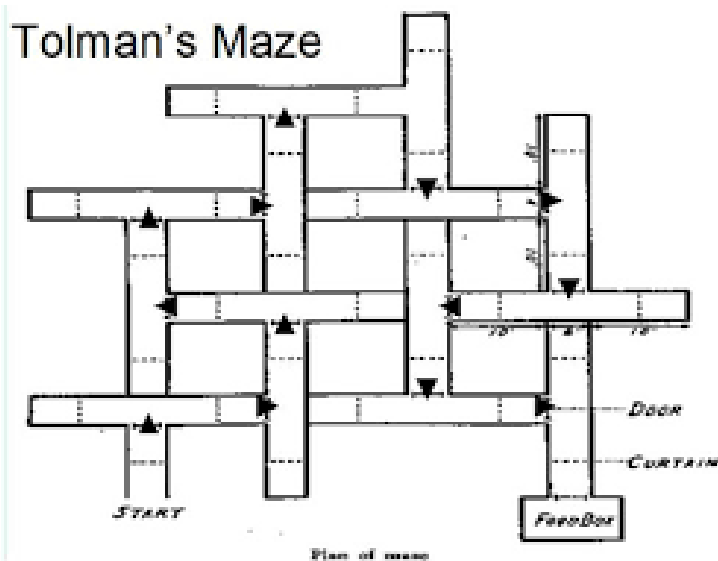

Figure 5.3: Tolman's experiments with animals learning to run through a maze form the foundation on which the work of John O'Keefe, May-Britt Moser and Edvard Moser was built.

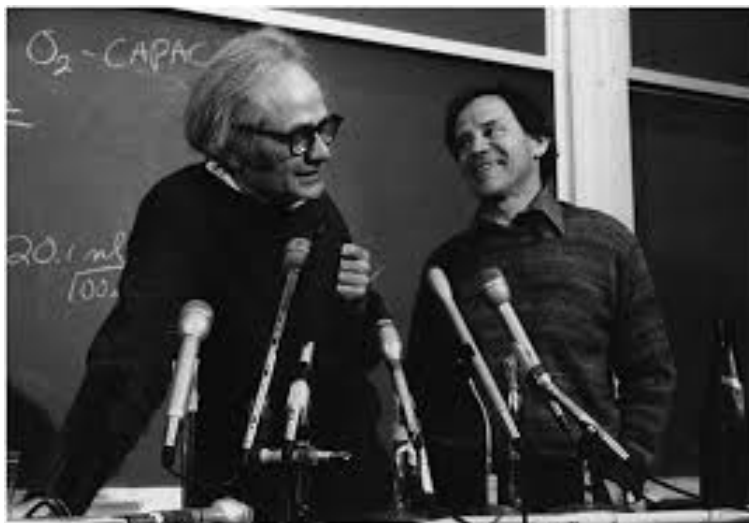

Figure 5.4: David H. Hubel and Torsten N. Wiesel broke the physiology-psychology boundary from the physiology side. By identifying the elementary neural components of the visual image at low levels of the visual cortex, they showed that psychological concepts, such as sensation and perception, could be understood through elementary interactions between cells with specific functions.

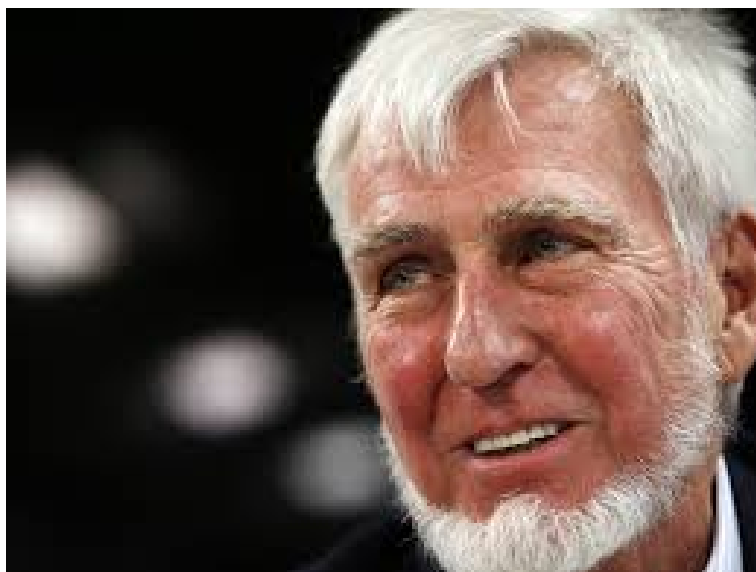

Figure 5.5: A photo of John O'Keefe, who discovered place cells in the hippocampus. Place cells are cells that fire specifically when an animal is at a certain location in its local environment.

could be related to specific elements of the visual image. This work set the stage for decades of investigation of the neural basis for vision and helped the emergence of a new field of cortical computation. Their insights at the low levels of the visual cortex provided a window into how the cortex might work. As a result of Hubel and Wiesel's work, parts of the coding mechanism for vision are now understood, almost 60 years after they started their investigations...

The potential for understanding a higher brain function brought May-Britt and me to John O'Keefe's lab in 1996. During a period of three months, John generously taught us everything about place cells and how they were studied and we then went back to Norway, to Trondheim, to set up our own new lab. One of our hopes was to find out how the place signal was generated.

In this overview, I will first review the events that led up to the discovery of grid cells and the organisation of a grid cell-based map of space in the medial entorhinal cortex. Then, in the second part, I will present recent work on the interactions between grid cells and the geometry of the external environment, the topography of the grid-cell map, and the mechanisms underlying the hexagonal symmetry of the grid cells.

To determine if place fields were formed in the intrahippocampal circuit, we worked together with neuroanatomist Menno Witter, then at the Free University of Amsterdam...

In 2005, with our students Torkel Hafting, Marianne Fyhn and Sturla

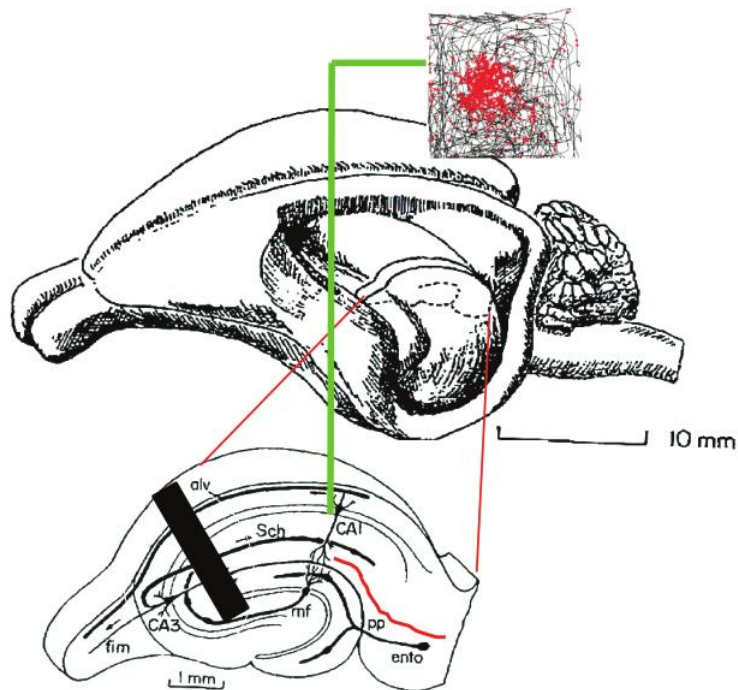

Figure 5.6: Location of recording electrode and lesion in the experiment that led us to move out of the hippocampus, to the entorhinal cortex.

Molden, we were able to describe the structure of the firing pattern. Using larger environments than in the past, we could clearly see that the firing pattern was periodic. The multiple firing fields of the cell formed a hexagonal grid that tiled the entire surface space available to the animal, much like the holes in a bee hive or a Chinese checkerboard. Many entorhinal cells fired like this, and we named them grid cells. We were excited about the grid-like firing pattern, both because nothing like it exists in the sensory inputs to the animal, suggesting that the pattern is generated intrinsically in the entorhinal cortex or neighbouring structures, and because such a regular pattern provides a metric to the brain's spatial map, a metric that had been missing in the place map of the hippocampus.

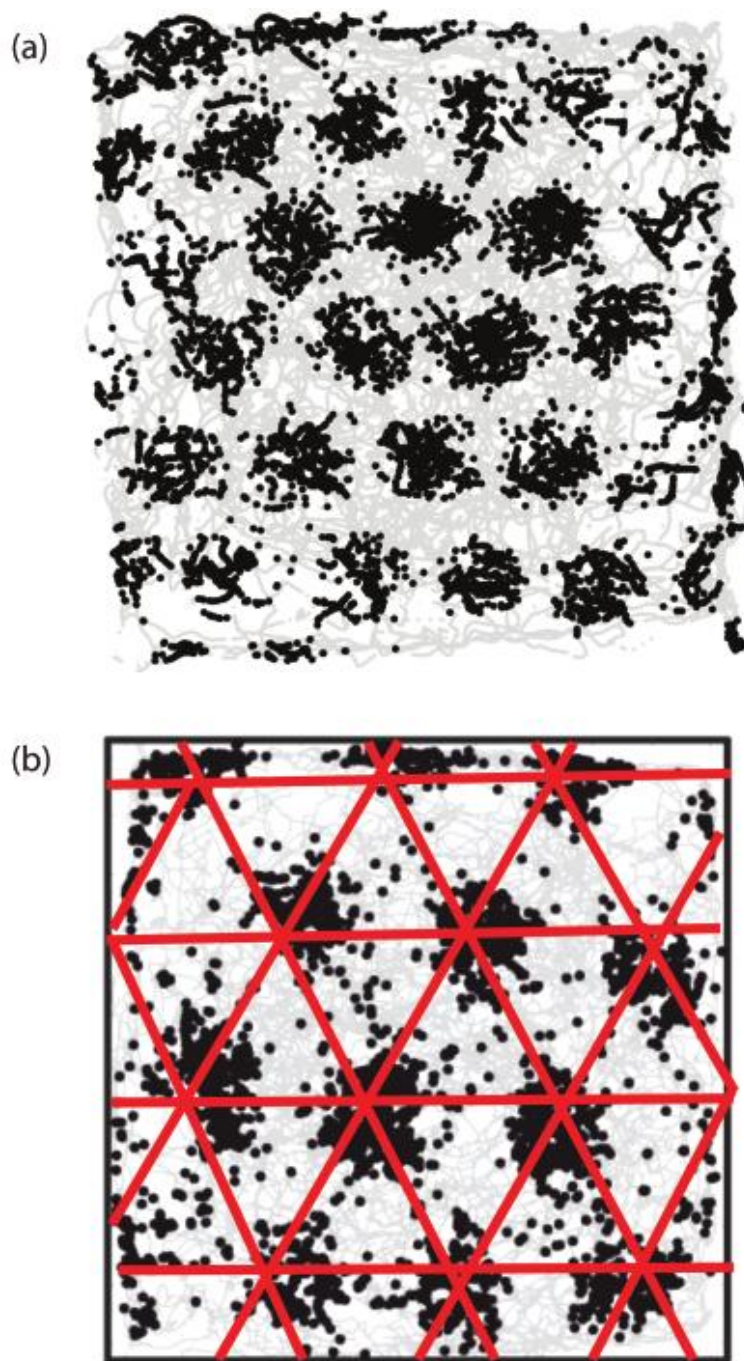

Figure 5.7: Firing pattern of grid cells. (a) Spatially periodic firing pattern of an entorhinal grid cell during 30 min of foraging in a 220 cm wide square enclosure. The trajectory of the rat is shown in grey, individual spike locations in black. (b) Firing pattern of a grid cell in a 1 m wide enclosure. Symbols as in (a) but with red lines superimposed to indicate the hexagonal structure of the grid. Modified from Stensola et al. (2012) and Hafting et al. (2005), respectively.

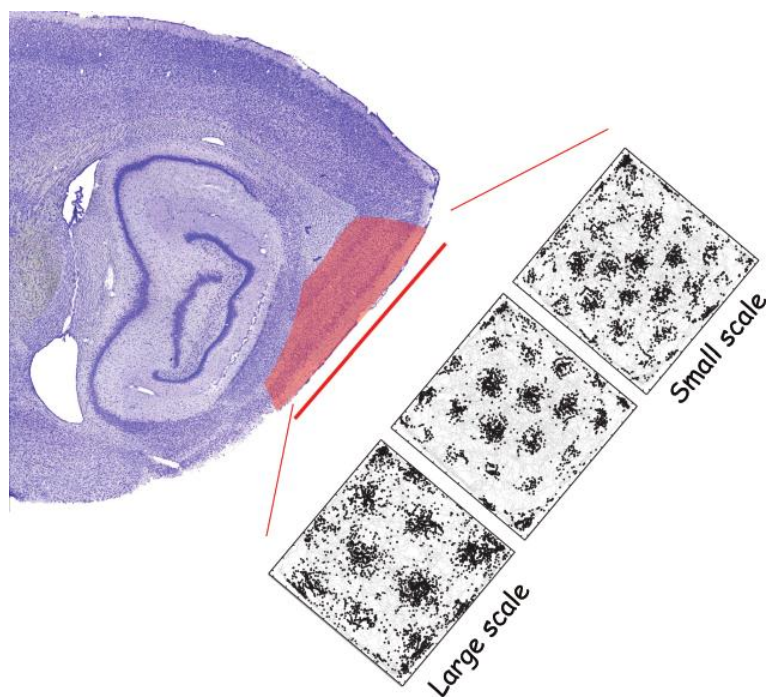

Figure 5.8: Topographical organisation of grid scale. The figure shows a sagittal brain section with medial entorhinal cortex indicated in red. Firing maps are shown for three grid cells recorded at successive dorso-ventral levels in medial entorhinal cortex. Note change from small scale to large scale along the dorso-ventral axis. Modified from Stensola et al. (2012).

5.2 Paths in cell differentiation

In animals, the fertilized egg cell divides a number of times to form the blastula. At this stage of development, the cells are unspecialized. However, as they continue to divide, the cells become increasingly specialized. First they are totipotent, then pluripotent, then multipotent, then oligopotent and finally unipotent. The increasingly specialized differentiation of cells is closely analogous to the increasingly specialized classification of destinations in package address systems, which will be discussed in the next section.

5.3 Paths in package address systems

The history of the Internet and World Wide Web

The history of the Internet began in 1961, when Leonard Kleinrock, a student at MIT, submitted a proposal for Ph.D. thesis entitled “Information Flow in Large Communication Nets”. In his statement of the problem, Kleinrock wrote: “The nets under consideration consist of nodes, connected to each other by links. The nodes receive, sort, store, and transmit messages that enter and leave via the links. The links consist of one-way channels, with fixed capacities. Among the typical systems which fit this description are the Post Office System, telegraph systems, and satellite communication systems.” Kleinrock’s theoretical treatment of package switching systems anticipated the construction of computer networks which would function on a principle analogous to a post office rather than a telephone exchange: In a telephone system, there is a direct connection between the sender and receiver of information. But in a package switching system, there is no such connection - only the addresses of the sender and receiver on the package of information, which makes its way from node to node until it reaches its destination.

Further contributions to the concept of package switching systems and distributed communications networks were made by J.C.R. Licklider and W. Clark of MIT in 1962, and by Paul Baran of the RAND corporation in 1964. Licklider visualized what he called a “Galactic Network”, a globally interconnected network of computers which would allow social interactions and interchange of data and software throughout the world. The distributed computer communication network proposed by Baran was motivated by the desire to have a communication system that could survive a nuclear war. The Cold War had also provoked the foundation (in 1957) of the Advanced Research Projects Agency (ARPA) by the U.S. government as a response to the successful Russian satellite “Sputnik”.

In 1969, a 4-node network was tested by ARPA. It connected computers at

the University of California divisions at Los Angeles and Santa Barbara with computers at the Stanford Research Institute and the University of Utah. Describing this event, Leonard Kleinrock said in an interview: “We set up a telephone connection between us and the guys at SRI. We typed the L and we asked on the phone ‘Do you see the L?’ ‘Yes we see the L’, came the response. We typed the 0 and we asked ‘Do you see the 0?’ ‘Yes we see the O.’ Then we typed the G and the system crashed.” The ARPANET (with 40 nodes) performed much better in 1972 at the Washington Hilton Hotel where the participants at a Conference on Computer Communications were invited to test it.

Although the creators of ARPANET visualized it as being used for long-distance computations involving several computers, they soon discovered that social interactions over the Internet would become equally important if not more so. An electronic mail system was introduced in the early 1970’s, and in 1976 Queen Elizabeth II of the United Kingdom became one of the increasing number of e-mail users.

In September, 1973, Robert F. Kahn and Vinton Cerf presented the basic ideas of the Internet at a meeting of the International Network Working Group at the University Sussex in Brighton, England. Among these principles was the rule that the networks to be connected should not be changed internally. Another rule was that if a packet did not arrive at its destination, it would be retransmitted from its original source. No information was to be retained by the gateways used to connect networks; and finally there was to be no global control of the Internet at the operations level.

Computer networks devoted to academic applications were introduced in the 1970’s and 1980’s, both in England, the United States and Japan. The Joint Academic Network (JANET) in the U.K. had its counterpart in the National Science Foundation’s network (NSFNET) in America and Japan’s JUNET (Japan Unix Network). Internet traffic is approximately doubling each year,¹ and it is about to overtake voice communication in the volume of information transferred.

In March, 2011, there were more than two billion Internet users in the world. In North America they amounted to 78.3 % of the total population, in Europe 58.3 % and worldwide, 30.2 %. Another index that can give us an impression of the rate of growth of digital data generation and exchange is the “digital universe”, which is defined to be the total volume of digital information that human information technology creates and duplicates in a year. In 2011 the digital universe reached 1.2 zettabytes, and it is projected to quadruple by 2015. A zettabyte is 10^{21} bytes, an almost unimaginable number,

¹ In the period 1995-1996, the rate of increase was even faster - a doubling every four months

equivalent to the information contained in a thousand trillion books, enough books to make a pile that would stretch twenty billion kilometers.

Postal addresses

A second example of package address systems can be found in postal addresses. Here the coarsest category is country. Within a particular country the city or town is the next part of the address. Next, the street is specified; then the street number, and finally (in some cases), the number labeling the room or flat within a building. This progression from course categorization to progressively finer specification of the address can be seen in all types of classification.

5.4 Paths in the organization of computer memories

Most of us use directories to organize the data on our computers. For example, on my own PC, the address of the file on which I am working at the moment is “home/work/books/languages”. There is a directory called “home”. Within “home” there are many sub-directories, one of which is called “work”. Suppose that we click on “work”. We find within this sub-directory many sub-sub-directories, one of which is called “books”. If, among the many options, we click on “books”, we find that it contains many sub-sub-sub-directories, one of which is called “languages”.

We can visualize the process of starting in the home directory and finally reaching the sub-sub-sub-directory “languages” as a process of pathfinding. At each point where the paths branch, we make a choice, just as an animal does when finding its way through a forest or maze. At each choice, the destination reached becomes more specific; the classification of destinations becomes more refined.

One is reminded of the postal address system, within which the destination of a letter becomes more refined at each branch: First the country is specified, then the city or town, then the street, then the house number, and finally (in some cases) the apartment or room. Here too, the destination becomes progressively more refined as one progresses through a set of choices.

One may even be reminded of the existentialist philosophy of Jean-Paul Sartre and others, which has the motto “existence is prior to essence”. As we progress through life, we make choices, and within each choice, we make sub-choices which define more and more specifically our final destination, i.e. our destiny or “essence”.

5.5 Pattern abstraction

Pattern abstraction in computers

Information technology and biology are today the two most rapidly developing fields of science. Interestingly, these two fields seem to be merging, each gaining inspiration and help from the other. For example, computer scientists designing both hardware and software are gaining inspiration from physiological studies of the mechanism of the brain; and conversely, neurophysiologists are aided by insights from the field of artificial intelligence. Designers of integrated circuits wish to prolong the period of validity of Moore's law; but they are rapidly approaching physical barriers which will set limits to the miniaturization of conventional transistors and integrated circuits. They gain inspiration from biology, where the language of molecular complementarity and the principle of autoassembly seem to offer hope that molecular switches and self-assembled integrated circuits may one day be constructed.

Geneticists, molecular biologists, biochemists and crystallographers have now obtained so much information about the amino acid sequences and structures of proteins and about the nucleotide sequences in genomes that the full power of modern information technology is needed to store and to analyze this information. Computer scientists, for their part, turn to evolutionary genetics for new and radical methods of developing both software and hardware - genetic algorithms and simulated evolution.

Self-assembly of supramolecular structures; Nanoscience

In previous chapters, we saw that the language of molecular complementarity (the "lock and key" fitting discovered by Paul Ehrlich) is the chief mechanism by which information is stored and transferred in biological systems. Biological molecules have physical shapes and patterns of excess charge² which are recognized by complementary molecules because they fit together, just as a key fits the shape of a lock. Examples of biological "lock and key" fitting are the fit between the substrate of an enzyme and the enzyme's active site, the recognition of an antigen by its specific antibody, the specificity of base pairs in DNA and RNA, and the autoassembly of structures such as viruses and subcellular organelles.

One of the best studied examples of autoassembly through the mechanism of molecular complementarity is the tobacco mosaic virus. The assembled virus has a cylindrical form about 300 nm long (1 nm = 1 nanometer = 10^{-9} meters

² They also have patterns of polarizable groups and reactive groups, and these patterns can also play a role in recognition.

= 10 Ångstroms), with a width of 18 nm. The cylindrically shaped virus is formed from about 2000 identical protein molecules. These form a package around an RNA molecule with a length of approximately 6400 nucleotides. The tobacco mosaic virus can be decomposed into its constituent molecules in vitro, and the protein and RNA can be separated and put into separate bottles, as was discussed in Chapter 4.

If, at a later time, one mixes the protein and RNA molecules together in solution, they spontaneously assemble themselves into new infective tobacco mosaic virus particles. The mechanism for this spontaneous autoassembly is a random motion of the molecules through the solvent until they approach each other in such a way that a fit is formed. When two molecules fit closely together, with their physical contours matching, and with complementary patterns of excess charge also matching, the Gibbs free energy of the total system is minimized. Thus the self-assembly of matching components proceeds spontaneously, just as every other chemical reaction proceeds spontaneously when the difference in Gibbs free energy between the products and reactants is negative. The process of autoassembly is analogous to crystallization, except that the structure formed is more complex than an ordinary crystal.

Perceptrons

In 1943, W. McCulloch and W. Pitts published a paper entitled *A Logical Calculus of the Ideas Immanent in Nervous Activity*. In this pioneering paper, they proposed the idea of a Threshold Logic Unit (TLU), which they visualized not only as a model of the way in which neurons function in the brain but also as a possible subunit for artificial systems which might be constructed to perform learning and pattern-recognition tasks. Problems involving learning, generalization, pattern recognition and noisy data are easily handled by the brains of humans and animals, but computers of the conventional von Neumann type find such tasks especially difficult.

Conventional computers consist of a memory and one or more central processing units (CPUs). Data and instructions are repeatedly transferred from the memory to the CPUs, where the data is processed and returned to the memory. The repeated performance of many such cycles requires a long and detailed program, as well as high-quality data. Thus conventional computers, despite their great speed and power, lack the robustness, intuition, learning powers and powers of generalization which characterize biological neural networks. In the 1950's, following the suggestions of McCulloch and Pitts, and inspired by the growing knowledge of brain structure and function which was being gathered by histologists and neurophysiologists, computer scientists began to construct artificial neural networks - massively parallel arrays of TLU's.

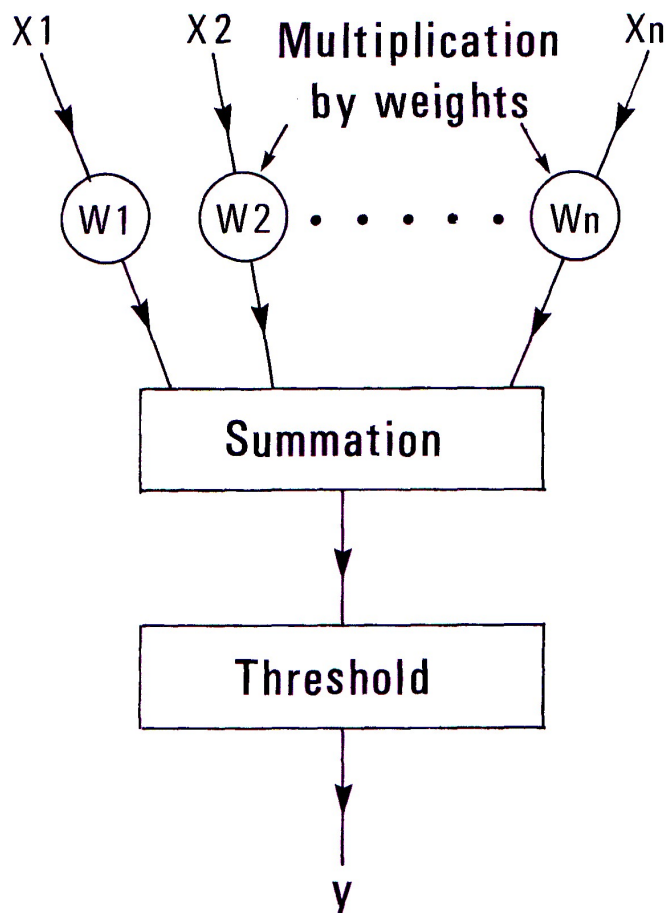

Figure 5.9: A Threshold Logic Unit (TLU) of the type proposed by McCulloch and Pitts.

The analogy between a TLU and a neuron can be seen by comparing Figure 2.6, which shows a neuron, with Figure 8.1, which shows a TLU. As we saw in Chapter 2, a neuron is a specialized cell consisting of a cell body (*soma*) from which an extremely long, tubelike fiber called an *axon* grows. The axon is analogous to the output channel of a TLU. From the soma, a number of slightly shorter, rootlike extensions called *dendrites* also grow. The dendrites are analogous to the input channels of a TLU.

In a biological neural network, branches from the axon of a neuron are connected to the dendrites of many other neurons; and at the points of connection there are small, knoblike structures called synapses. As was discussed in Chapter 5, the “firing” of a neuron sends a wave of depolarization out

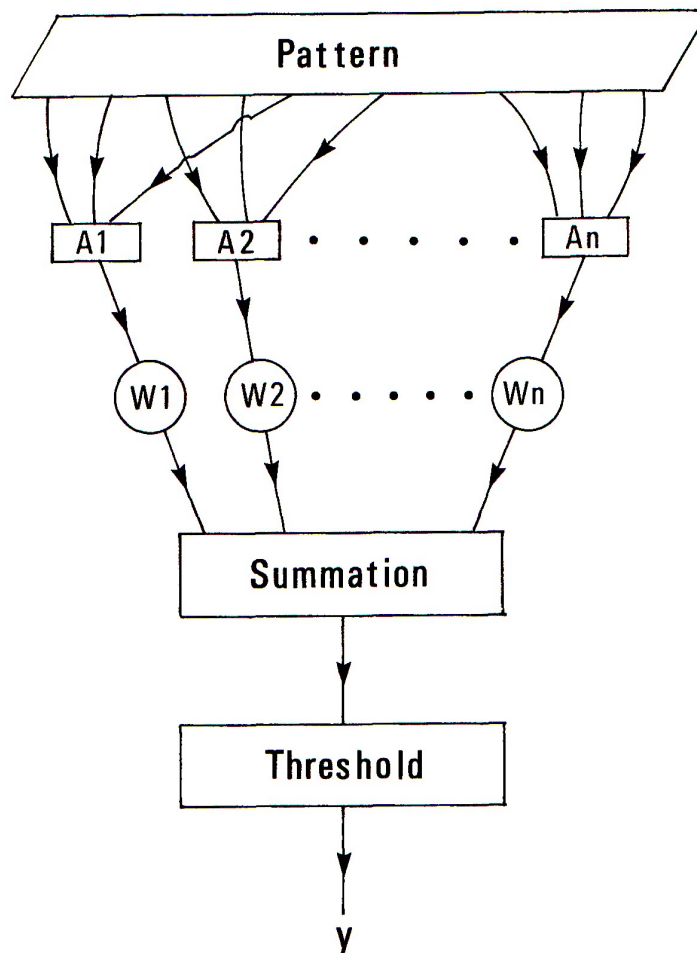

Figure 5.10: A perceptron, introduced by Rosenblatt in 1962. The perceptron is similar to a TLU, but its input is preprocessed by a set of association units (A-units). The A-units are not trained, but are assigned a fixed Boolean functionality.

along its axon. When the pulslike electrical and chemical disturbance associated with the wave of depolarization (the action potential) reaches a synapse, where the axon is connected with another neuron, transmitter molecules are released into the post-synaptic cleft. The neurotransmitter molecules travel across the post-synaptic cleft to receptors on a dendrite of the next neuron in the net, where they are bound to receptors. There are many kinds of neurotransmitter molecules, some of which tend to make the firing of the next neuron more probable, and others which tend to inhibit its firing. When the neurotransmitter molecules are bound to the receptors, they cause a change in the dendritic membrane potential, either increasing or decreasing its polarization. The post-synaptic potentials from the dendrites are propagated to the soma; and if their sum exceeds a threshold value, the neuron fires. The subtlety of biological neural networks derives from the fact that there are many kinds of neurotransmitters and synapses, and from the fact that synapses are modified by their past history.

Turning to Figure 8.1, we can compare the biological neuron with the Threshold Logic Unit of McCulloch and Pitts. Like the neuron, the TLU has many input channels. To each of the N channels there is assigned a weight, w_1, w_2, \dots, w_N . The weights can be changed; and the set of weights gives the TLU its memory and learning capabilities. Modification of weights in the TLU is analogous to the modification of synapses in a neuron, depending on their history. In the most simple type of TLU, the input signals are either 0 or 1. These signals, multiplied by their appropriate weights, are summed, and if the sum exceeds a threshold value, θ the TLU “fires”, i.e. a pulse of voltage is transmitted through the output channel to the next TLU in the artificial neural network.

Let us imagine that the input signals, x_1, x_2, \dots, x_N can take on the values 0 or 1. The weighted sum of the input signals will then be given by

$$a = \sum_{j=1}^N w_j x_j \quad (5.1)$$

The quantity a , is called the *activation*. If the activation exceeds the threshold θ , the unit “fires”, i.e. it produces an output y given by

$$y = \begin{cases} 1 & \text{if } a \geq \theta \\ 0 & \text{if } a < \theta \end{cases} \quad (5.2)$$

The decisions taken by a TLU can be given a geometrical interpretation: The input signals can be thought of as forming the components of a vector, $x = x_1, x_2, \dots, x_N$, in an N -dimensional space called pattern space. The weights

also form a vector, $w = w_1, w_2, \dots, w_N$, in the same space. If we write an equation setting the scalar product of these two vectors equal to some constant,

$$\mathbf{w} \cdot \mathbf{x} \equiv \sum_{j=1}^N w_j x_j = \theta \quad (5.3)$$

then this equation defines a hyperplane in pattern space, called the *decision hyperplane*. The decision hyperplane divides pattern space into two parts - (1) input pulse patterns which will produce firing of the TLU, and (2) patterns which will not cause firing.

The position and orientation of the decision hyperplane can be changed by altering the weight vector w and/or the threshold θ . Therefore it is convenient to put the threshold and the weights on the same footing by introducing an augmented weight vector,

$$\mathbf{W} = w_1, w_2, \dots, w_N, \theta \quad (5.4)$$

and an augmented input pattern vector,

$$\mathbf{X} = x_1, x_2, \dots, x_N, -1 \quad (5.5)$$

In the $N+1$ -dimensional augmented pattern space, the decision hyperplane now passes through the origin, and equation (8.3) can be rewritten in the form

$$\mathbf{W} \cdot \mathbf{X} \equiv \sum_{j=1}^{N+1} W_j X_j = 0 \quad (5.6)$$

Those input patterns for which the scalar product $\mathbf{W} \cdot \mathbf{X}$ is positive or zero will cause the unit to fire, but if the scalar product is negative, there will be no response.

If we wish to “teach” a TLU to fire when presented with a particular pattern vector \mathbf{X} , we can evaluate its scalar product with the current augmented weight vector \mathbf{W} . If this scalar product is negative, the TLU will not fire, and therefore we know that the weight vector needs to be changed. If we replace the weight vector by

$$\mathbf{W}' = \mathbf{W} + \gamma \mathbf{X} \quad (5.7)$$

where γ is a small positive number, then the new augmented weight vector \mathbf{W}' will point in a direction more nearly the same as the direction of \mathbf{X} . This change will be a small step in the direction of making the scalar product positive, i.e. a small step in the right direction.

Why not take a large step instead of a small one? A small step is best because there may be a whole class of input patterns to which we would like

the TLU to respond by firing. If we make a large change in weights to help a particular input pattern, it may undo previous learning with respect to other patterns.

It is also possible to teach a TLU to remain silent when presented with a particular input pattern vector. To do so we evaluate the augmented scalar product $\mathbf{W} \cdot \mathbf{X}$ as before, but now, when we desire silence rather than firing, we wish the scalar product to be negative, and if it is positive, we know that the weight vector must be changed. In changing the weight vector, we can again make use of equation (8.7), but now γ must be a small negative number rather than a small positive one.

Two sets of input patterns, A and B, are said to be linearly separable if they can be separated by some decision hyperplane in pattern space. Now suppose that the four sets, A, B, C, and D, can be separated by two decision hyperplanes. We can then construct a two-layer network which will identify the class of an input signal belonging to any one of the sets, as is illustrated in Figure 8.2.

The first layer consists of two TLU's. The first TLU in this layer is taught to fire if the input pattern belongs to A or B, and to be silent if the input belongs to C or D. The second TLU is taught to fire if the input pattern belongs to A or D, and to be silent if it belongs to B or C. The second layer of the network consists of four output units which are not taught, but which are assigned a fixed Boolean functionality. The first output unit fires if the signals from the first layer are given by the vector $\mathbf{y} = \{0, 0\}$ (class A); the second fires if $\mathbf{y} = \{0, 1\}$ (class B), the third if $\mathbf{y} = \{1, 0\}$ (class C), and the fourth if $\mathbf{y} = \{1, 1\}$ (class D). Thus the simple two-layer network shown in Figure 8.2 functions as a *classifier*. The output units in the second layer are analogous to the "grandmother's face cells" whose existence in the visual cortex is postulated by neurophysiologists. These cells will fire if and only if the retina is stimulated with a particular class of patterns.

This very brief glance at artificial neural networks does not do justice to the high degree of sophistication which network architecture and training algorithms have achieved during the last two decades. However, the suggestions for further reading at the end of this chapter may help to give the reader an impression of the wide range of problems to which these networks are now being applied.

Besides being useful for computations requiring pattern recognition, learning, generalization, intuition, and robustness in the face of noisy data, artificial neural networks are important because of the light which they throw on the mechanism of brain function. For example, one can compare the classifier network shown in Figure 8.2 with the discoveries of Kuffler, Hubel and Wessel concerning pattern abstraction in the mammalian retina and visual cortex.

Pattern abstraction in the octopus brain

J.Z. Young lectures to the Wells Society at Imperial College

I vividly remember a lecture that Prof. J.Z. Young delivered to the Wells Society³ of London's Imperial College of Science and Technology. It was during the early 1960's, and at that time I was writing my Ph.D. thesis in theoretical chemistry.

Professor Young told us of his research on the visual cortex of the octopus. Being a mollusc, the octopus is lucky to have eyes at all, but in fact its eyes are very similar to our own, a striking example of convergent evolution. Young's research combined microscopic examination of extremely thin slices of the octopus brain with experiments on the extent to which the octopus is able to learn, and to profit from past experience.

Each image on the retina of the octopus eye is directly mapped in a one to one manner onto the outer layer of the animal's visual cortex. But as the signal propagated inwards towards the center of the visual cortex, the arrangement of dendrites and axons insures that synapses would only fire if activated by a specific pattern. The specificity of the pattern becomes progressively more refined as it propagates more deeply into the cortex.

Finally a "grandmother's face cell" is reached, a cell which can only be activated by a specific pattern. At this point in the visual cortex of the octopus, neural pathways to parts of the brain controlling muscular actions are activated. The paths branched, with one leading towards an attack response and the other towards retreat. There is a bias towards the attack pathway, so that initially, any pattern observed by the eyes of the animal will produce an attack.

Professor Young told us that he could actually see the arrangements of dendrites and axons in his histological studies of the visual cortex of the octopus. These histological studies were supplemented by behavioral experiments, in which the octopus was either rewarded for the attack, or else punished with a mild electric shock. If rewarded, the animal would continue to attack when again presented with the same pattern. If punished, the animal would always retreat when presented with the same stimulus. Prof. Young explained this behaviour by postulating the existence of a feedback neural circuit which blocked the attack pathway if the animal was punished. When the signal subsequently passed the "grandmother's face cell", only the retreat pathway remained. The octopus had learned.

³H.G. Wells had once been a student at Imperial College, London. and the Wells Society was named after him.



Figure 5.11: Prof. John Zachary Young, FRS, in 1978. He has been described as “one of the most influential biologists of the 20th century”. His studies of pattern abstraction in the visual cortex of the octopus combined examination of histological microsections with experimental studies of octopus learning.

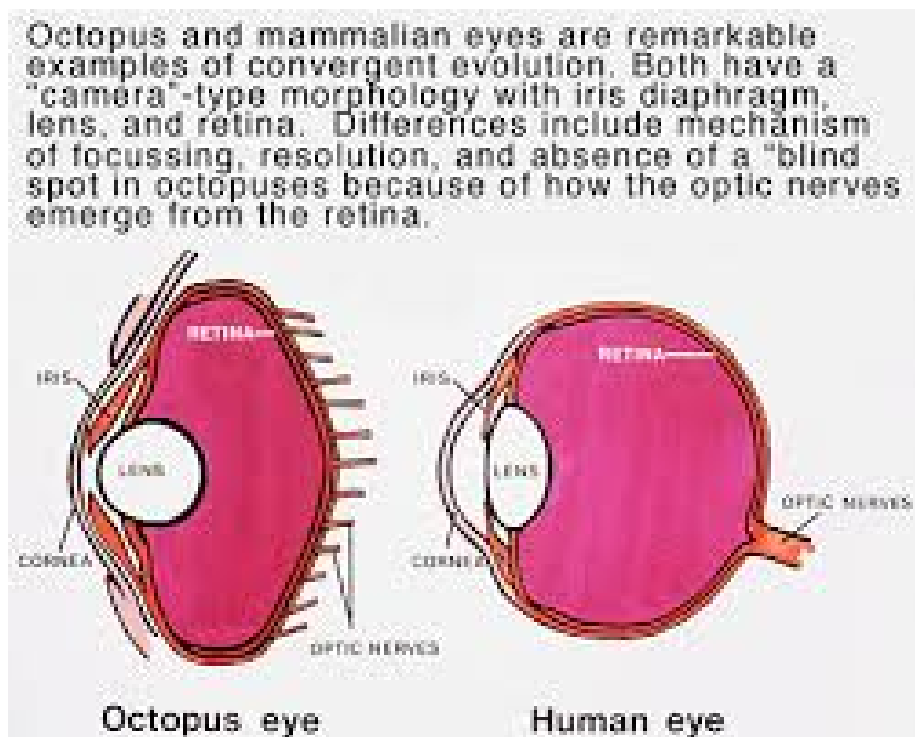

Figure 5.12: The octopus eye, like the human eye, has an image-forming lens and a retina. This similarity is a striking example of convergent evolution. The common ancestor of humans and molluscs had no eye at all.

5.6 Abstraction of concepts and natural laws

Can two contradictory statements both be true? The physicist Niels Bohr thought that this could happen, and he called such an occurrence “complementarity”. I think that I understand what Niels Bohr meant: Whenever we make a statement about the real world we are making a model which is simpler than what it is supposed to represent. Therefore every statement must to some extent be false because it is an oversimplification. In fact, a model of the world is an abstraction, and it is possible to make two conflicting abstractions, starting with the same real object.

If you say, “The eye is like a camera”, you are making an abstraction by concentrating on the way that the eye works and the way that a camera works. Both use a lens to form an image. If you say “The eye is like a small onion”, you are again making an abstraction, but this time concentrating the size and texture of the eye. It is somewhat round, elastic and damp. If you drop it on a stone floor, it will bounce rather than breaking. Both these abstractions have a certain degree of truth, although they are contradictory.

Similarly, science and ethics are both abstractions, and both oversimplify the real world, which is much more complex than either of them. Which abstraction we should use depends on the problem that we wish to discuss. If we are talking about atomic spectra, then Schrödinger and Dirac should be our guides. But if the lecture is on how to achieve peace in the world, I would far rather hear it from Mahatma Gandhi than from either Schrödinger or Dirac.

In his autobiography, Charles Darwin says that “Science consists in arranging facts in such a way that general conclusions may be drawn from them”. At the lowest level of abstraction, we have a very large number of individual observations. A number of these observations may be gathered together to form a low-level generalization. The low-level generalizations may in turn be coordinated into a somewhat more general law, and so on. Today one hears that physicists are aiming at a “theory of everything”, which, if could ever be achieved, would coordinate all individual observations of every kind.

Suggestions for further reading

1. H. Babbage, *Babbages Calculating Engines: A Collection of Papers by Henry Prevost Babbage*, MIT Press, (1984).
2. A.M. Turing, *The Enigma of Intelligence*, Burnett, London (1983).
3. Ft. Penrose, *The Emperor’s New Mind: Concerning Computers, Minds, and the Laws of Physics*, Oxford University Press, (1989).
4. S. Wolfram, *A New Kind of Science*, Wolfram Media, Champaign IL, (2002).

5. A.M. Turing, *On computable numbers, with an application to the Entscheidungsproblem*, Proc. Lond. Math. Soc. Ser 2, **42**, (1937). Reprinted in M. David Ed., *The Undecidable*, Raven Press, Hewlett N.Y., (1965).
6. N. Metropolis, J. Howlett, and Gian-Carlo Rota (editors), *A History of Computing in the Twentieth Century*, Academic Press (1980).
7. J. Shurkin, *Engines of the Mind: A History of Computers*, W.W. Norton, (1984).
8. J. Palfreman and D. Swade, *The Dream Machine: Exploring the Computer Age*, BBC Press (UK), (1991).
9. T.J. Watson, Jr. and P. Petre, *Father, Son, and Co.*, Bantam Books, New York, (1991).
10. A. Hodges, Alan Turing: *The Enigma*, Simon and Schuster, (1983).
11. H.H. Goldstein, *The Computer from Pascal to Von Neumann*, Princeton University Press, (1972).
12. C.J. Bashe, L.R. Johnson, J.H. Palmer, and E.W. Pugh, *IBM's Early Computers*, Vol. 3 in the History of Computing Series, MIT Press, (1986).
13. K.D. Fishman, *The Computer Establishment*, McGraw-Hill, (1982).
14. S. Levy, *Hackers*, Doubleday, (1984).
15. S. Franklin, *Artificial Minds*, MIT Press, (1997).
16. P. Freiburger and M. Swaine, *Fire in the Valley: The Making of the Personal Computer*, Osborne/McGraw-Hill, (1984).
17. R.X. Cringely, *Accidental Empires*, Addison-Wesley, (1992).
18. R. Randell editor, *The Origins of Digital Computers, Selected Papers*, Springer-Verlag, New York (1973).
19. H. Lukoff, *From Dits to Bits*, Robotics Press, (1979).
20. D.E. Lundstrom, *A Few Good Men from Univac*, MIT Press, (1987).
21. D. Rutland, *Why Computers Are Computers (The SWAC and the PC)*, Wren Publishers, (1995).
22. P.E. Ceruzzi, *Reckoners: The Prehistory of the Digital Computer, from Relays to the Stored Program Concept, 1935-1945*, Greenwood Press, Westport, (1983)
23. S.G. Nash, *A History of Scientific Computing*, Addison-Wesley, Reading Mass., (1990).
24. P.E. Ceruzzi, *Crossing the divide: Architectural issues and the emergence of stored programme computers, 1935-1953*, IEEE Annals of the History of Computing, **19**, 5-12, January-March (1997).
25. P.E. Ceruzzi, *A History of Modern Computing*, MIT Press, Cambridge MA, (1998).
26. K. Zuse, *Some remarks on the history of computing in Germany*, in *A History of Computing in the 20th Century*, N. Metropolis et al. editors, 611-627, Academic Press, New York, (1980).

27. A.R. Mackintosh, *The First Electronic Computer*, Physics Today, March, (1987).
28. S.H. Hollingdale and G.C. Tootil, *Electronic Computers*, Penguin Books Ltd. (1970).
29. A. Hodges, *Alan Turing: The Enigma*, Simon and Schuster, New York, (1983).
30. A. Turing, *On computable numbers with reference to the Entscheidungsproblem*, Journal of the London Mathematical Society, **II**, **2**. **42**, 230-265 (1937).
31. J. von Neumann, *The Computer and the Brain*, Yale University Press, (1958).
32. I.E. Sutherland, *Microelectronics and computer science*, Scientific American, 210-228, September (1977).
33. W. Aspray, *John von Neumann and the Origins of Modern Computing*, M.I.T. Press, Cambridge MA, (1990, 2nd ed. 1992).
34. W. Aspray, *The history of computing within the history of information technology*, History and Technology, **11**, 7-19 (1994).
35. G.F. Luger, *Computation and Intelligence: Collected Readings*, MIT Press, (1995).
36. Z.W. Pylyshyn, *Computation and Cognition: Towards a Foundation for Cognitive Science*, MIT Press, (1986).
37. D.E. Shasha and C. Lazere, *Out of Their Minds: The Creators of Computer Science*, Copernicus, New York, (1995).
38. W. Aspray, *An annotated bibliography of secondary sources on the history of software*, Annals of the History of Computing **9**, 291-243 (1988).
39. R. Kurzweil, *The Age of Intelligent Machines*, MIT Press, (1992).
40. S.L. Garfinkel and H. Abelson, eds., *Architects of the Information Society: Thirty-Five Years of the Laboratory for Computer Sciences at MIT*, MIT Press, (1999).
41. J. Haugeland, *Artificial Intelligence: The Very Idea*, MIT Press, (1989).
42. M.A. Boden, *Artificial Intelligence in Psychology: Interdisciplinary Essays*, MIT Press, (1989).
43. J.W. Cortada, *A Bibliographic Guide to the History of Computer Applications, 1950-1990*, Greenwood Press, Westport Conn., (1996).
44. M. Campbell-Kelly and W. Aspry, *Computer: A History of the Information Machine*, Basic Books, New York, (1996).
45. B.I. Blum and K. Duncan, editors, *A History of Medical Informatics*, ACM Press, New York, (1990).
46. J.-C. Guedon, La Planete Cyber, *Internet et Cyberspace*, Gallimard, (1996).

47. S. Augarten, *Bit by Bit: An Illustrated History of Computers*, Unwin, London, (1985).
48. N. Wiener, *Cybernetics; or Control and Communication in the Animal and the Machine*, The Technology Press, John Wiley and Sons, New York, (1948).
49. W.R. Ashby, *An Introduction to Cybernetics*, Chapman and Hall, London, (1956).
50. M.A. Arbib, *A partial survey of cybernetics in eastern Europe and the Soviet Union*, Behavioral Sci., **11**, 193-216, (1966).
51. A. Rosenblueth, N. Wiener and J. Bigelow, *Behavior, purpose and teleology*, Phil. Soc. **10** (1), 18-24 (1943).
52. N. Wiener and A. Rosenblueth, *Conduction of impulses in cardiac muscle*, Arch. Inst. Cardiol. Mex., **16**, 205-265 (1946).
53. H. von Foerster, editor, *Cybernetics - circular, causal and feed-back mechanisms in biological and social systems. Transactions of sixth-tenth conferences*, Josiah J. Macy Jr. Foundation, New York, (1950- 1954).
54. W.S. McCulloch and W. Pitts, *A logical calculus of ideas immanent in nervous activity*, Bull. Math. Biophys., **5**, 115-133 (1943).
55. W.S. McCulloch, *An Account of the First Three Conferences on Teleological Mechanisms*, Josiah Macy Jr. Foundation, (1947).
56. G.A. Miller, *Languages and Communication*, McGraw-Hill, New York, (1951).
57. G.A. Miller, *Statistical behavioristics and sequences of responses*, Psychol. Rev. **56**, 6 (1949).
58. G. Bateson, *Bali - the value system of a steady state*, in M. Fortes, editor, *Social Structure Studies Presented to A.R. Radcliffe-Brown*, Clarendon Press, Oxford, (1949).
59. G. Bateson, *Communication, the Social Matrix of Psychiatry*, Norton, (1951).
60. G. Bateson, *Steps to an Ecology of Mind*, Chandler, San Francisco, (1972).
61. G. Bateson, *Communication et Societe*, Seuil, Paris, (1988).
62. S. Heims, *Gregory Bateson and the mathematicians: From interdisciplinary interactions to societal functions*, J. History Behavioral Sci., **13**, 141-159 (1977).
63. S. Heims, *John von Neumann and Norbert Wiener. From Mathematics to the Technology of Life and Death*, MIT Press, Cambridge MA, (1980).
64. S. Heims, *The Cybernetics Group*, MIT Press, Cambridge MA, (1991).
65. G. van de Vijver, *New Perspectives on Cybernetics (Self-Organization, Autonomy and Connectionism)*, Kluwer, Dordrecht, (1992).

66. A. Bavelas, *A mathematical model for group structures*, Appl. Anthropol. **7 (3)**, 16 (1948).
67. P. de Latil, *La Pensee Artificielle - Introduction a la Cybernetique*, Gallimard, Paris, (1953).
68. L.K. Frank, G.E. Hutchinson, W.K. Livingston, W.S. McCulloch and N. Wiener, *Teleological Mechanisms*, Ann. N.Y. Acad. Sci. **50**, 187- 277 (1948).
69. H. von Foerster, *Quantum theory of memory*, in H. von Foerster, editor, *Cybernetics - circular, causal and feed-back mechanisms in biological and social systems*. Transactions of the sixth conferences, Josiah J. Macy Jr. Foundation, New York, (1950).
70. H. von Foerster, *Observing Systems*, Intersystems Publications, California, (1984).
71. H. von Foerster, *Understanding Understanding: Essays on Cybernetics and Cognition*, Springer, New York, (2002).
72. M. Newborn, *Kasparov vs. Deep Blue: Computer Chess Comes of age*, Springer Verlag, (1996).
73. K.M. Colby, *Artificial Paranoia: A Computer Simulation of the Paranoid Process*, Pergamon Press, New York, (1975).
74. J.Z. Young, *Discrimination and learning in the octopus*, in H. von Foerster, editor, *Cybernetics - circular, causal and feed-back mechanisms in biological and social systems*. Transactions of the ninth conference, Josiah J. Macy Jr. Foundation, New York, (1953).
75. M.J. Apter and L. Wolpert, *Cybernetics and development*. I. Information theory, J. Theor. Biol. **8**, 244-257 (1965).
76. H. Atlan, *L'Organization Biologique et la Theorie de l'Information*, Hermann, Paris, (1972).
77. H. Atlan, *On a formal definition of organization*, J. Theor. Biol. **45**, 295-304 (1974).
78. H. Atlan, *Organization du vivant, information et auto-organization*, in Volume Symposium 1986 de l'Encyclopediea Universalis, pp. 355-361, Paris, (1986).
79. E.R. Kandel, *Nerve cells and behavior*, Scientific American, **223**, 57-70, July, (1970).
80. E.R. Kandel, *Small systems of neurons*, Scientific American, **241 no.3**, 66-76 (1979).
81. A.K. Katchalsky et al., *Dynamic patterns of brain cell assemblies*, Neurosciences Res. Prog. Bull., **12 no.1**, (1974).
82. G.E. Moore, *Cramming more components onto integrated circuits*, Electronics, April 19, (1965).

83. P. Gelsinger, P. Gargini, G. Parker and A. Yu, *Microprocessors circa 2000*, IEEE Spectrum, October, (1989).
84. P. Baron, *On distributed communications networks*, IEEE Trans. Comm. Systems, March (1964).
85. V.G. Cerf and R.E. Khan, *A protocol for packet network intercommunication*, Trans. Comm. Tech. **COM-22**, **V5**, 627-641, May (1974).
86. L. Kleinrock, *Communication Nets: Stochastic Message Flow and Delay*, McGraw-Hill, New York, (1964).
87. L. Kleinrock, *Queueing Systems: Vol. II, Computer Applications*, Wiley, New York, (1976).
88. R. Kahn, editor, *Special Issue on Packet Communication Networks*, Proc. IEEE, **66**, November, (1978).
89. L.G. Roberts, *The evolution of packet switching*, Proc. of the IEEE **66**, 1307-13, (1978).
90. J. Abbate, *The electrical century: Inventing the web*, Proc. IEEE **87**, November, (1999).
91. J. Abbate, *Inventing the Internet*, MIT Press, Cambridge MA, (1999).
92. J.C. McDonald, editor, *Fundamentals of Digital Switching, 2nd Edition*, Plenum, New York, (1990).
93. B. Metcalfe, *Packet Communication, Peer-to-Peer Communication*, San Jose Calif, (1996).
94. T. Berners-Lee, *The Original Design and Ultimate Destiny of the World Wide Web by its Inventor*, Harper San Francisco, (1999).
95. J. Clark, *Netscape Time: The Making of the Billion-Dollar Start-Up That Took On Microsoft*, St. Martin's Press, New York, (1999).
96. J. Wallace, *Overdrive: Bill Gates and the Race to Control Cyberspace*, Wiley, New York, (1997).
97. P. Cunningham and F. Froschl, *The Electronic Business Revolution*, Springer Verlag, New York, (1999).
98. J.L. McKenny, *Waves of Change: Business Evolution Through Information Technology*, Harvard Business School Press, (1995).
99. M.A. Cosumano, *Competing on Internet Time: Lessons From Netscape and Its Battle with Microsoft*, Free Press, New York, (1998).
100. F.J. Dyson, *The Sun, the Genome and the Internet: Tools of Scientific Revolutions*, Oxford University Press, (1999).
101. L. Bruno, *Fiber Optimism: Nortel, Lucent and Cisco are battling to win the high-stakes fiber-optics game*, Red Herring, June (2000).
102. N. Cochrane, *We're insatiable: Now it's 20 million million bytes a day*, Melbourne Age, January 15, (2001).
103. K.G. Coffman and A.N. Odlyzko, *The size and growth rate of the Internet*, First Monday, October, (1998).

104. C.A. Eldering, M.L. Sylla, and J.A. Eisenach, *Is there a Moore's law for bandwidth?*, IEEE Comm. Mag., 2-7, October, (1999).
105. G. Gilder, *Fiber keeps its promise: Get ready, bandwidth will triple each year for the next 25 years*, Forbes, April 7, (1997).
106. A.M. Noll, *Does data traffic exceed voice traffic?*, Comm. ACM, 121-124, June, (1999).
107. B. St. Arnaud, J. Coulter, J. Fitchett, and S. Mokbel, *Architectural and engineering issues for building an optical Internet*, Proc. Soc. Optical Eng. (1998).
108. M. Weisner, *The computer for the 21st century*, Scientific American, September, (1991).
109. R. Wright, *Three Scientists and Their Gods*, Time Books, (1988).
110. S. Nora and A. Mine, *The Computerization of Society*, MIT Press, (1981).
111. T. Forester, *Computers in the Human Context: Information Theory, Productivity, and People*, MIT Press, (1989).
112. P. Friedland and L.H. Kedes, *Discovering the secrets of DNA*, Comm. of the ACM, **28**, 1164-1185 (1985).
113. E.F. Meyer, *The first years of the protein data bank*, Protein Science **6**, 1591-7, July (1997).
114. C. Kulikowski, *Artificial intelligence in medicine: History, evolution and prospects*, in Handbook of Biomedical Engineering, J. Bronzine editor, 181.1-181.18, CRC and IEEE Press, Boca Raton Fla., (2000).
115. C. Gibas and P. Jambeck, *Developing Bioinformatics Computer Skills*, O'Reily, (2001).
116. F.L. Carter, *The molecular device computer: point of departure for large-scale cellular automata*, Physica D, **10**, 175-194 (1984).
117. K.E. Drexler, *Molecular engineering: an approach to the development of general capabilities for molecular manipulation*, Proc. Natl. Acad. Sci USA, **78**, 5275-5278 (1981).
118. K.E. Drexler, *Engines of Creation*, Anchor Press, Garden City, New York, (1986).
119. D.M. Eigler and E.K. Schweizer, *Positioning single atoms with a scanning electron microscope*, Nature, **344**, 524-526 (1990).
120. E.D. Gilbert, editor, *Miniaturization*, Reinhold, New York, (1961).
121. R.C. Haddon and A.A. Lamola, *The molecular electronic devices and the biochip computer: present status*, Proc. Natl. Acad. Sci. USA, **82**, 1874-1878 (1985).
122. H.M. Hastings and S. Waner, *Low dissipation computing in biological systems*, BioSystems, **17**, 241-244 (1985).
123. J.J. Hopfield, J.N. Onuchic and D.N. Beritan, *A molecular shift register based on electron transfer*, Science, **241**, 817-820 (1988).

124. L. Keszthelyi, *Bacteriorhodopsin*, in *Bioenergetics*, P. P. Graber and G. Millazo (editors), Birkhäuser Verlag, Basel Switzerland, (1997).
125. F.T. Hong, *The bacteriorhodopsin model membrane as a prototype molecular computing element*, *BioSystems*, **19**, 223-236 (1986).
126. L.E. Kay, *Life as technology: Representing, intervening and molecularizing*, *Rivista di Storia della Scienza*, **II**, **1**, 85-103 (1993).
127. A.P. Alivisatos et al., *Organization of 'nanocrystal molecules' using DNA*, *Nature*, **382**, 609-611, (1996).
128. T. Bjørnholm et al., *Self-assembly of regioregular, amphiphilic polythiophenes into highly ordered pi-stacked conjugated thin films and nanocircuits*, *J. Am. Chem. Soc.* **120**, 7643 (1998).
129. L.J. Fogel, A.J. Owens, and M.J. Walsh, *Artificial Intelligence Through Simulated Evolution*, John Wiley, New York, (1966).
130. L.J. Fogel, *A retrospective view and outlook on evolutionary algorithms*, in *Computational Intelligence: Theory and Applications*, in *5th Fuzzy Days*, B. Reusch, editor, Springer-Verlag, Berlin, (1997).
131. P.J. Angeline, *Multiple interacting programs: A representation for evolving complex behaviors*, *Cybernetics and Systems*, **29** (8), 779-806 (1998).
132. X. Yao and D.B. Fogel, editors, *Proceedings of the 2000 IEEE Symposium on Combinations of Evolutionary Programming and Neural Networks*, IEEE Press, Piscataway, NJ, (2001).
133. R.M. Brady, *Optimization strategies gleaned from biological evolution*, *Nature* **317**, 804-806 (1985).
134. K. Dejong, *Adaptive system design - a genetic approach*, *IEEE Syst. M.* **10**, 566-574 (1980).
135. W.B. Dress, *Darwinian optimization of synthetic neural systems*, *IEEE Proc. ICNN* **4**, 769-776 (1987).
136. J.H. Holland, *A mathematical framework for studying learning in classifier systems*, *Physica* **22 D**, 307-313 (1986).
137. R.F. Albrecht, C.R. Reeves, and N.C. Steele (editors), *Artificial Neural Nets and Genetic Algorithms*, Springer Verlag, (1993).
138. L. Davis, editor, *Handbook of Genetic Algorithms*, Van Nostrand Reinhold, New York, (1991).
139. Z. Michalewicz, *Genetic Algorithms + Data Structures = Evolution Programs*, Springer-Verlag, New York, (1992), second edition, (1994).
140. K.I. Diamantaris and S.Y. Kung, *Principal Component Neural Networks: Theory and Applications*, John Wiley and Sons, New York, (1996).
141. A. Garliauskas and A. Soliunas, *Learning and recognition of visual patterns by human subjects and artificial intelligence systems*, *Informatika*, **9** (4), (1998).

142. A. Garliauskas, *Numerical simulation of dynamic synapse-dendrite-soma neuronal processes*, Informatica, **9 (2)**, 141-160, (1998).
143. U. Seifert and B. Michaelis, *Growing multi-dimensional self-organizing maps*, International Journal of Knowledge-Based Intelligent Engineering Systems, **2 (1)**, 42-48, (1998).
144. S. Mitra, S.K. Pal, and M.K. Kundu, *Finger print classification using fuzzy multi-layer perceptron*, Neural Computing and Applications, **2**, 227-233 (1994).
145. M. Verleysen (editor), *European Symposium on Artificial Neural Networks*, D-Facto, (1999).
146. R.M. Golden, *Mathematical Methods for Neural Network Analysis and Design*, MIT Press, Cambridge MA, (1996).
147. S. Haykin, *Neural Networks - (A) Comprehensive Foundation*, MacMillan, New York, (1994).
148. M.A. Gronroos, *Evolutionary Design of Neural Networks*, Thesis, Computer Science, Department of Mathematical Sciences, University of Turku, Finland, (1998).
149. D.E. Goldberg, *Genetic Algorithms in Search, Optimization and Machine Learning*, Addison-Wesley, (1989).
150. M. Mitchell, *An Introduction to Genetic Algorithms*, MIT Press, Cambridge MA, (1996).
151. L. Davis (editor), *Handbook of Genetic Algorithms*, Van Nostrand and Reinhold, New York, (1991).
152. J.H. Holland, *Adaptation in Natural and Artificial Systems*, MIT Press, Cambridge MA, (1992).
153. J.H. Holland, *Hidden Order; How Adaptation Builds Complexity*, Addison Wesley, (1995).
154. W. Banzhaf, P. Nordin, R.E. Keller and F. Francone, *Genetic Programming - An Introduction; On the Automatic Evolution of Computer Programs and its Applications*, Morgan Kaufmann, San Francisco CA, (1998).
155. W. Banzhaf et al. (editors), *(GECCO)-99: Proceedings of the Genetic Evolutionary Computation Conference*, Morgan Kaufman, San Francisco CA, (2000).
156. W. Banzhaf, *Editorial Introduction, Genetic Programming and Evolvable Machines*, **1**, 5-6, (2000).
157. W. Banzhaf, *The artificial evolution of computer code, IEEE Intelligent Systems*, **15**, 74-76, (2000).
158. J.J. Grefenstette (editor), *Proceedings of the Second International Conference on Genetic Algorithms and their Applications*, Lawrence Erlbaum Associates, Hillsdale New Jersey, (1987).

159. J. Koza, *Genetic Programming: On the Programming of Computers by means of Natural Selection*, MIT Press, Cambridge MA, (1992).
160. J. Koza et al., editors, *Genetic Programming 1997: Proceedings of the Second Annual Conference*, Morgan Kaufmann, San Francisco, (1997).
161. W.B. Langdon, *Genetic Programming and Data Structures*, Kluwer, (1998).
162. D. Lundh, B. Olsson, and A. Narayanan, editors, *Bio-Computing and Emergent Computation 1997*, World Scientific, Singapore, (1997).
163. P. Angeline and K. Kinnear, editors, *Advances in Genetic Programming: Volume 2*, MIT Press, (1997).
164. J.H. Holland, *Adaptation in Natural and Artificial Systems*, The University of Michigan Press, Ann Arbor, (1975).
165. David B. Fogel and Wirt Atmar (editors), *Proceedings of the First Annual Conference on Evolutionary Programming, Evolutionary Programming Society*, La Jolla California, (1992).
166. M. Sipper et al., *A phylogenetic, ontogenetic, and epigenetic view of bioinspired hardware systems*, IEEE Transactions in Evolutionary Computation **1**, 1 (1997).
167. E. Sanchez and M. Tomassini, editors, *Towards Evolvable Hardware*, Lecture Notes in Computer Science, 1062, Springer-Verlag, (1996).
168. J. Markoff, *A Darwinian creation of software*, New York Times, Section C, p.6, February 28, (1990).
169. A. Thompson, *Hardware Evolution: Automatic design of electronic circuits in reconfigurable hardware by artificial evolution*, Distinguished dissertation series, Springer-Verlag, (1998).
170. W. McCulloch and W. Pitts, *A Logical Calculus of the Ideas Immanent in Nervous Activity*, Bulletin of Mathematical Biophysics, **7**, 115-133, (1943).
171. F. Rosenblatt, *Principles of Neurodynamics*, Spartan Books, (1962).
172. C. von der Malsburg, *Self-Organization of Orientation Sensitive Cells in the Striate Cortex*, Kybernetik, **14**, 85-100, (1973).
173. S. Grossberg, *Adaptive Pattern Classification and Universal Recoding: 1. Parallel Development and Coding of Neural Feature Detectors*, Biological Cybernetics, **23**, 121-134, (1976).
174. J.J. Hopfield and D.W. Tank, *Computing with Neural Circuits: A Model*, Science, **233**, 625-633, (1986).
175. R.D. Beer, *Intelligence as Adaptive Behavior: An Experiment in Computational Neuroethology*, Academic Press, New York, (1990).
176. S. Haykin, *Neural Networks: A Comprehensive Foundation*, IEEE Press and Macmillan, (1994).
177. S.V. Kartalopoulos, *Understanding Neural Networks and Fuzzy Logic: Concepts and Applications*, IEEE Press, (1996).

178. D. Fogel, *Evolutionary Computation: The Fossil Record*, IEEE Press, (1998).
179. D. Fogel, *Evolutionary Computation: Toward a New Philosophy of Machine Intelligence*, IEEE Press, Piscataway NJ, (1995).
180. J.M. Zurada, R.J. Marks II, and C.J. Robinson, editors, *Computational Intelligence: Imitating Life*, IEEE Press, (1994).
181. J. Bezdek and S.K. Pal, editors, *Fuzzy Models for Pattern Recognition: Methods that Search for Structure in Data*, IEEE Press, (1992).
182. M.M. Gupta and G.K. Knopf, editors, *Neuro-Vision Systems: Principles and Applications*, IEEE Press, (1994).
183. C. Lau, editor, *Neural Networks. Theoretical Foundations and Analysis*, IEEE Press, (1992).
184. T. Back, D.B. Fogel and Z. Michalewicz, editors, *Handbook of Evolutionary Computation*, Oxford University Press, (1997).
185. D.E. Rumelhart and J.L. McClelland, *Parallel Distributed Processing: Explorations in the Micro structure of Cognition, Volumes I and II*, MIT Press, (1986).
186. J. Hertz, A. Krogh and R.G. Palmer, *Introduction to the Theory of Neural Computation*, Addison Wesley, (1991).
187. J.A. Anderson and E. Rosenfeld, *Neurocomputing: Foundations of Research*, MIT Press, (1988).
188. R.C. Eberhart and R.W. Dobbins, *Early neural network development history: The age of Camelot*, IEEE Engineering in Medicine and Biology **9**, 15-18 (1990).
189. T. Kohonen, *Self-Organization and Associative Memory*, Springer-Verlag, Berlin, (1984).
190. T. Kohonen, *Self-Organizing Maps*, Springer-Verlag, Berlin, (1997).
191. G.E. Hinton, *How neural networks learn from experience*, Scientific American **267**, 144-151 (1992).
192. K. Swingler, *Applying Neural Networks: A Practical Guide*, Academic Press, New York, (1996).
193. B.K. Wong, T.A. Bodnovich and Y. Selvi, *Bibliography of neural network business applications research: 1988-September 1994*, Expert Systems **12**, 253-262 (1995).
194. I. Kaastra and M. Boyd, *Designing neural networks for forecasting financial and economic time series*, Neurocomputing **10**, 251-273 (1996).
195. T. Poddig and H. Rehkugler, *A world model of integrated financial markets using artificial neural networks*, Neurocomputing **10**, 2251-273 (1996).
196. J.A. Burns and G.M. Whiteside, *Feed forward neural networks in chemistry: Mathematical systems for classification and pattern recognition*, Chem. Rev. **93**, 2583-2601, (1993).

197. M.L. Action and P.W. Wilding, *The application of backpropagation neural networks to problems in pathology and laboratory medicine*, Arch. Pathol. Lab. Med. **116**, 995-1001 (1992).
198. D.J. Maddalena, *Applications of artificial neural networks to problems in quantitative structure activity relationships*, Exp. Opin. Ther. Patents **6**, 239-251 (1996).
199. W.G. Baxt, *Application of artificial neural networks to clinical medicine*, [Review], Lancet **346**, 1135-8 (1995).
200. A. Chablo, *Potential applications of artificial intelligence in telecommunications*, Technovation **14**, 431-435 (1994).
201. D. Horwitz and M. El-Sibaie, *Applying neural nets to railway engineering*, AI Expert, 36-41, January (1995).
202. J. Plummer, *Tighter process control with neural networks*, 49-55, October (1993).
203. T. Higuchi et al., *Proceedings of the First International Conference on Evolvable Systems: From Biology to Hardware (ICES96)*, Lecture Notes on Computer Science, Springer-Verlag, (1997).
204. S.A. Kaufman, *Antichaos and adaptation*, Scientific American, **265**, 78-84, (1991).
205. S.A. Kauffman, *The Origins of Order*, Oxford University Press, (1993).
206. M.M. Waldrop, *Complexity: The Emerging Science at the Edge of Order and Chaos*, Simon and Schuster, New York, (1992).
207. H.A. Simon, *The Science of the Artificial, 3rd Edition*, MIT Press, (1996).
208. M.L. Hooper, *Embryonic Stem Cells: Introducing Planned Changes into the Animal Germline*, Harwood Academic Publishers, Philadelphia, (1992).
209. F. Grosveld, (editor), *Transgenic Animals*, Academic Press, New York, (1992).
210. G. Kohler and C. Milstein, *Continuous cultures of fused cells secreting antibody of predefined specificity*, Nature, **256**, 495-497 (1975).
211. S. Spiegelman, *An approach to the experimental analysis of precellular evolution*, Quarterly Reviews of Biophysics, **4**, 213-253 (1971).
212. M. Eigen, *Self-organization of matter and the evolution of biological macromolecules*, Naturwissenschaften, **58**, 465-523 (1971).
213. M. Eigen and W. Gardiner, *Evolutionary molecular engineering based on RNA replication*, Pure and Applied Chemistry, **56**, 967-978 (1984).
214. G.F. Joyce, *Directed molecular evolution*, Scientific American **267** (6), 48-55 (1992).
215. N. Lehman and G.F. Joyce, *Evolution in vitro of an RNA enzyme with altered metal dependence*, Nature, **361**, 182-185 (1993).
216. E. Culotta, *Forcing the evolution of an RNA enzyme in the test tube*, Science, **257**, 31 July, (1992).

217. S.A. Kauffman, *Applied molecular evolution*, Journal of Theoretical Biology, **157**, 1-7 (1992).
218. H. Fenniri, *Combinatorial Chemistry. A Practical Approach*, Oxford University Press, (2000).
219. P. Seneci, *Solid-Phase Synthesis and Combinatorial Technologies*, John Wiley & Sons, New York, (2001).
220. G.B. Fields, J.P. Tam, and G. Barany, *Peptides for the New Millennium*, Kluwer Academic Publishers, (2000).
221. Y.C. Martin, *Diverse viewpoints on computational aspects of molecular diversity*, Journal of Combinatorial Chemistry, **3**, 231-250, (2001).
222. C.G. Langton et al., editors, *Artificial Life II: Proceedings of the Workshop on Artificial Life Held in Santa Fe, New Mexico*, Addison-Wesley, Reading MA, (1992).
223. W. Aspray and A. Burks, eds., *Papers of John von Neumann on Computers and Computer Theory*, MIT Press, (1967).
224. M. Conrad and H.H. Pattee, *Evolution experiments with an artificial ecosystem*, J. Theoret. Biol., **28**, (1970).
225. C. Emmeche, *Life as an Abstract Phenomenon: Is Artificial Life Possible?*, in *Toward a Practice of Artificial Systems: Proceedings of the First European Conference on Artificial Life*, MIT Press, Cambridge MA, (1992).
226. C. Emmeche, *The Garden in the Machine: The Emerging Science of Artificial Life*, Princeton University Press, Princeton NJ, (1994).
227. S. Levy, *Artificial Life: The Quest for New Creation*, Pantheon, New York, (1992).
228. K. Lindgren and M.G. Nordahl, *Cooperation and Community Structure in Artificial Ecosystems*, Artificial Life, **1**, 15-38 (1994).
229. P. Husbands and I. Harvey (editors), *Proceedings of the 4th Conference on Artificial Life (ECAL '97)*, MIT Press, (1997).
230. C.G. Langton, (editor), *Artificial Life: An Overview*, MIT Press, Cambridge MA, (1997).
231. C.G. Langton, ed., *Artificial Life*, Addison-Wesley, (1987).
232. A.A. Beaudry and G.F. Joyce, *Directed evolution of an RNA enzyme*, Science, **257**, 635-641 (1992).
233. D.P. Bartel and J.W. Szostak, *Isolation of new ribozymes from a large pool of random sequences*, Science, 261, 1411-1418 (1993).
234. K. Kelly, *Out of Control*, www.kk.org/outofcontrol/index.html, (2002).
235. K. Kelly, *The Third Culture*, Science, February 13, (1998).
236. S. Blakeslee, *Computer life-form "mutates" in an evolution experiment, natural selection is found at work in a digital world*, New York Times, November 25, (1997).

237. M. Ward, *It's life, but not as we know it*, New Scientist, July 4, (1998).
238. P. Guinnessy, "*Life*" *crawls out of the digital soup*, New Scientist, April 13, (1996).
239. L. Hurst and R. Dawkins, *Life in a test tube*, Nature, May 21, (1992).
240. J. Maynard Smith, *Byte-sized evolution*, Nature, February 27, (1992).
241. W.D. Hillis, *Intelligence as an Emergent Behavior*, in *Artificial Intelligence*, S. Graubard, ed., MIT Press, (1988).
242. T.S. Ray, *Evolution and optimization of digital organisms*, in *Scientific Excellence in Supercomputing: The IBM 1990 Contest Prize Papers*, K.R. Billingsly, E. Derohanes, and H. Brown, III, editors, The Baldwin Press, University of Georgia, Athens GA 30602, (1991).
243. S. Lloyd, *The calculus of intricacy*, The Sciences, October, (1990).
244. M. Minsky, *The Society of Mind*, Simon and Schuster, (1985).
245. D. Pines, ed., *Emerging Synthesis in Science*, Addison-Wesley, (1988).
246. P. Prusinkiewicz and A. Lindenmayer, *The Algorithmic Beauty of Plants*, Springer-Verlag, (1990).
247. T. Tommaso and N. Margolus, *Cellular Automata Machines: A New Environment for Modeling*, MIT Press, (1987).
248. W.M. Mitchell, *Complexity: The Emerging Science at the Edge of Order and Chaos*, Simon and Schuster, (1992).
249. T.S. Ray et al., *Kurtzweil's Turing Fallacy*, in *Are We Spiritual Machines?: Ray Kurzweil vs. the Critics of Strong AI*, J. Richards, ed., Viking, (2002).
250. T.S. Ray, *Aesthetically Evolved Virtual Pets*, in *Artificial Life 7 Workshop Proceedings*, C.C. Maley and E. Bordreau, eds., (2000).
251. T.S. Ray and J.F. Hart, *Evolution of Differentiation in Digital Organisms*, in *Artificial Life VII, Proceedings of the Seventh International Conference on Artificial Life*, M.A. Bedau, J.S. McCaskill, N.H. Packard, and S. Rasmussen, eds., MIT Press, (2000).
252. T.S. Ray, *Artificial Life*, in *Frontiers of Life, Vol. 1: The Origins of Life*, R. Dulbecco et al., eds., Academic Press, (2001).
253. T.S. Ray, *Selecting naturally for differentiation: Preliminary evolutionary results*, Complexity, **3 (5)**, John Wiley and Sons, (1998).
254. K. Sims, *Artificial Evolution for Computer Graphics*, *Computer Graphics*, **25 (4)**, 319-328 (1991).
255. K. Sims, Galapagos, <http://web.genarts.com/galapagos> , (1997).

Chapter 6

THE EVOLUTION OF HUMAN LANGUAGES

Despite the impressive achievements of Koko, discussed in Chapter 3, one must conclude that human language abilities, with their enormous vocabularies and grammatical structures, are qualitatively different from animal languages. But what is the exact evolutionary history of human languages? Can this history be traced to specific mutations which are identifiable in the genomes of humans and homonids?

6.1 Chomsky's assertion of rapid change

Institute Professor Noam Chomsky of MIT, and more recently the University of Arizona, was born in 1928 in Philadelphia. Today he is considered to be the world's greatest public intellectual, and is famed as a linguist, philosopher, cognitive scientist, historian, social critic, and political activist. The author of more than 100 books, Prof. Chomsky has been called "the father of modern linguistics".

Noam Chomsky began studies at the University of Pennsylvania at the age of 16. His courses there included linguistics, mathematics, and philosophy.

The Wikipedia article on Prof. Chomsky states that "From 1951 to 1955 he was appointed to Harvard University's Society of Fellows, where he developed the theory of transformational grammar for which he was awarded his doctorate in 1955. That year he began teaching at MIT, in 1957 emerging as a significant figure in the field of linguistics for his landmark work *Syntactic Structures*, which remodeled the scientific study of language, while from 1958 to 1959 he was a National Science Foundation fellow at the Institute for Advanced Study. He is credited as the creator or co-creator of the universal

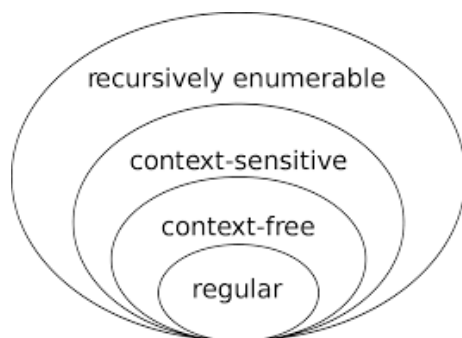

Figure 6.1: The Chomsky hierarchy. In the formal languages of computer science and linguistics, the Chomsky hierarchy is a containment hierarchy of classes of formal grammars. This hierarchy of grammars was described by Noam Chomsky in 1956. It is sometimes also called the Chomsky-Schützenberger hierarchy after Marcel-Paul Schützenberger, who played a crucial role in the development of the theory of formal languages.

grammar theory, the generative grammar theory, the Chomsky hierarchy, and the minimalist program.

“Since the 1960s, Chomsky has maintained that syntactic knowledge is at least partially inborn, implying that children need only learn certain parochial features of their native languages. Chomsky based his argument on observations about human language acquisition, noting that there is an enormous gap between the linguistic stimuli to which children are exposed and the rich linguistic knowledge they attain (see: ‘poverty of the stimulus’ argument). For example, although children are exposed to only a finite subset of the allowable syntactic variants within their first language, they somehow acquire the ability to understand and produce an infinite number of sentences, including ones that have never before been uttered.

“To explain this, Chomsky reasoned that the primary linguistic data (PLD) must be supplemented by an innate linguistic capacity. Furthermore, while a human baby and a kitten are both capable of inductive reasoning, if they are exposed to exactly the same linguistic data, the human will always acquire the ability to understand and produce language, while the kitten will never acquire either ability.

“Chomsky labeled whatever relevant capacity the human has that the cat lacks as the language acquisition device (LAD), and he suggested that one of the tasks for linguistics should be to determine what the LAD is and what constraints it imposes on the range of possible human languages. The universal features that would result from these constraints constitute ‘universal grammar’.”



Figure 6.2: The world-famous linguist, Institute Professor Noam Chomsky, believes that human languages are qualitatively different from animal languages, and that humans acquired their amazing linguistic abilities very quickly. We need to examine the detailed molecular mechanisms by which this could have occurred, bearing in mind Gerrod's one-gene-one-protein hypothesis and Darwin's picture of evolution through many gradual steps. We also need to bear in mind Darwin's discussion of serial homologies.

6.2 Parse trees

A parse tree is an ordered, rooted tree that represents the syntactic structure of a string according to some context-free grammar.

1. S for sentence, the top-level structure in this example
2. NP for noun phrase. The first (leftmost) NP, a single noun "John", serves as the subject of the sentence. The second one is the object of the sentence.
3. VP for verb phrase, which serves as the predicate
4. V for verb. In this case, it's a transitive verb hit.
5. D for determiner, in this instance the definite article "the"
6. N for noun

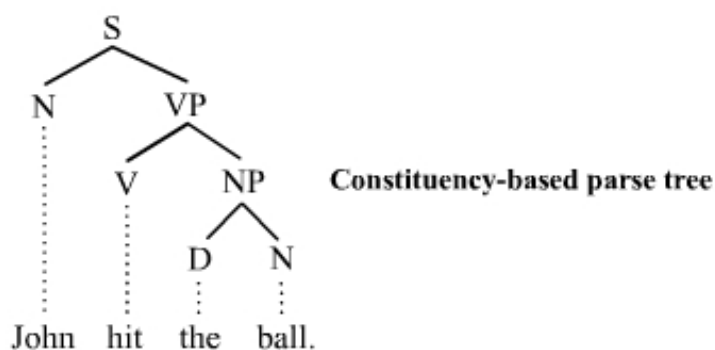

Figure 6.3: The tree-like structure of grammar in the parse tree analysis is analogous to the classification systems discussed in Chapter 5 (Pathfinding).

6.3 Garrod's hypothesis

In 1909, the English physician, Archibald Garrod, proposed a one-gene- one-protein hypothesis. He believed that hereditary diseases are due to the absence of specific enzymes. According to Garrod's hypothesis, damage suffered by a gene results in the faulty synthesis of the corresponding enzyme, and loss of the enzyme ultimately results in the symptoms of the hereditary disease.

In the 1940's, Garrod's hypothesis was confirmed by experiments on the mold, *Neurospora*, performed at Stanford University by George Beadle and Edward Tatum. They demonstrated that mutant strains of the mold would grow normally, provided that specific extra nutrients were added to their diets. The need for these dietary supplements could in every case be traced to the lack of a specific enzyme in the mutant strains. Linus Pauling later extended these ideas to human genetics by showing that the hereditary disease, sickle-cell anemia, is due to a defect in the biosynthesis of hemoglobin.

6.4 The FOXP2 gene and protein

Interestingly, a gene which seems to be closely associated with human speech has recently been located and mapped by C.S.L. Lai *et al*, who reported their results in *Nature*, **413**, 2001. These authors studied three generations of the "KE" family, 15 members of which are afflicted with a severe speech disorder. In all of the afflicted family members, a gene called FOXP2 on chromosome 7 is defective. In another unrelated individual, "CS", with a strikingly similar speech defect, the abnormality was produced by chromosomal translocation, the breakpoint coinciding exactly with the location of the FOXP2 gene.

A still more recent study of the FOXP2 gene was published online in *Nature AOP* on August 14, 2002. The authors (Wolfgang Enard, Molly Przeworski, Cecilia S.L. Lai, Victor Wiebe, Takashi Kitano, Anthony P. Monaco, and Svante Paabo) sequenced the FOXP2 gene and protein in the chimpanzee, gorilla, orang-utan, rhesus macaque and mouse, comparing the results with sequences of human FOXP2. They found that in the line from the common ancestor of mouse and man to the point where the human genome branches away from that of the chimp, there are many nucleotide substitutions, but all are silent, i.e. they have no effect at all on the FOXP2 protein. The even more numerous non-silent DNA mutations which must have taken place during this period seem to have been rejected by natural selection because of the importance of conserving the form of the protein. However, in the human line after the human-chimp fork, something dramatic happens: There are only two base changes, but both of them affect the protein! This circumstance suggests to Enard et al that the two alterations in the human FOXP2 protein conferred

a strong evolutionary advantage, and they speculate that this advantage may have been an improved capacity for language.

The case of the FOXP2 gene and protein illustrates Gerrod's hypothesis: We see here the one-gene-one-protein hypothesis in action. A single mutation seems to have produced a severe speech and linguistic disorder in the "KE" family.

6.5 Slow evolutionary change; serial homologies

The fact each individual mutation affects a single gene, and hence the synthesis of a single protein, explains the gradual steps observed in evolution, first by Charles Darwin, and later by many other researchers. A mutation produces a small change in the morphology and functions of an organism, and the change is preserved if beneficial.

In Chapter 1, we discussed serial homologies, and quoted Darwin's discussion from *The Origin of Species*: "serial homologies", - cases where symmetrically repeated parts of an ancient progenitor have been modified for special purposes in their descendants. For example, the bones which fit together to form the brain case in reptiles, birds and mammals can be seen in fossil sequences to be modified vertebrae of an ancient progenitor.

After discussing many examples, Darwin exclaims, "How inexplicable are these cases of serial homologies on the ordinary view of creation! Why should the brain be enclosed in a box composed of such numerous and extraordinarily-shaped pieces of bone?... Why should similar bones have been created to form the wing and leg of a bat, used as they are for totally different purposes, namely walking and flying? Why should one crustacean, which has an extremely complex mouth, formed of many parts, consequently have fewer legs; or conversely, those with many legs have simpler mouths? Why should the sepals, petals, stamens and pistils in each flower, though fitted for such distinct purposes, be all constructed on the same pattern?... On the theory of natural selection we can, to a certain extent, answer these questions.... An indefinite repetition of the same part is the common characteristic of all low or little-specialized forms... We have already seen that parts many times repeated are eminently liable to vary... Consequently such parts, being already present in considerable numbers, and being highly variable, would naturally afford materials for adaption to the most different purposes."

There are many cases where a single mutation seems to have produced duplication of a structure. For example, we sometimes see the birth of an animal with two heads, or supernumerary legs. In

the light of Professor Chomsky's observation that human languages are qualitatively different from animal languages, and his belief that modern humans acquired their astonishing linguistic abilities very rapidly, we ought to investigate the possibility that a single mutation caused a duplication of the pathfinding neural networks studied by Edvard Moser, May-Britt Moser, and John O'Keefe. We can then imagine that one copy of this duplicated pathfinding neural network system was modified to serve as the basis of human languages, in which the classification of words is closely analogous to the tree-like branching choice-pathways of an animal finding its way through a forest or maze.¹

How could we test such an hypothesis? Hopefully the methods of Svante Pääbo and his colleagues to sequence the genomes of ancient progenitors of humans may be able to provide us with answers.

6.6 The Neanderthal and Denisovan genomes

Prof. Dr. Svante Pääbo and his colleagues at the Max Planck institute for Evolutionary Anthropology recently published a high-coverage genome of a Neanderthal. The genome was extracted from the bone fragment of a Neanderthal female from around 50,000-100,000 years ago, found in a cave in the Altai mountains of Siberia.²

Svante Pääbo and his colleagues were also able to find the complete genetic sequence of the Denisovans, an eastern cousin of the Neanderthals. One can hope that this brilliant work can be extended to even more ancient branches of the human family tree, perhaps even to *Homo erectus*. By working with genome differences between humans and their ancestors, paeleogeneticists may in the future be able to date the mutation or mutations that made human language qualitatively different from the languages of animals.

¹Bold face is used here because this paragraph contains the central message of this book.

²<http://www.eva.mpg.de/neandertal/index.html>

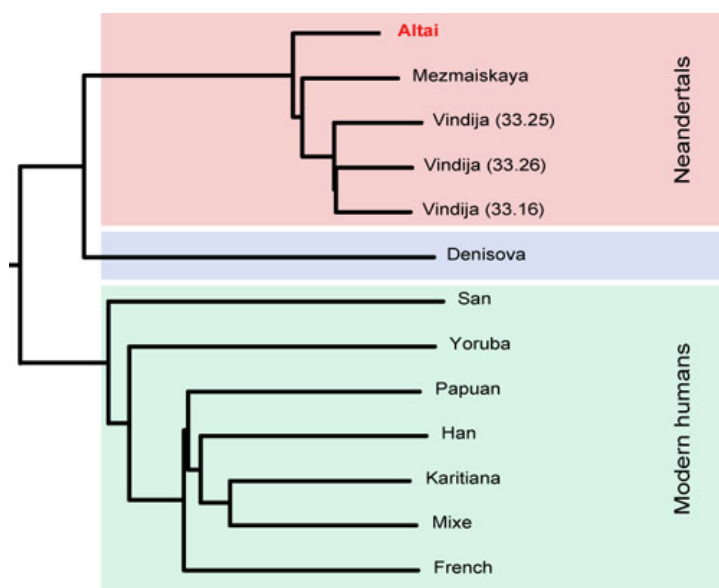

Figure 6.4: The family tree of Neanderthals, Denisovans and modern humans.



Figure 6.5: The Denisova cave in the Altai Mountains of Siberia was once the home of a hermit, Denis, and the cave takes its name from him. The photo shows tourists visiting the cave. It was here that scientists found the finger bone and tooth of a female hominid. The species, which they named Denisovan after the cave where the remains were found, proved to be the eastern cousins of the Neanderthals.

Suggestions for further reading

1. Chomsky, Noam (1956). *Three models for the description of language* (PDF). IRE Transactions on Information Theory (2): 113-124. doi:10.1109/TIT.1956.1056813.
2. Michael Sipser (1997). Introduction to the Theory of Computation 1st. Cengage Learning. ISBN 0-534-94728-X. *The Church-Turing Thesis (Page 130)*
3. Chomsky, Noam (1959). *On certain formal properties of grammars* (PDF). Information and Control. 2 (2): 137-167. doi:10.1016/S0019-9958(59)90362-6.
4. Chomsky, Noam; Schützenberger, Marcel P. (1963). *The algebraic theory of context free languages*. In Braffort, P.; Hirschberg, D. Computer Programming and Formal Languages. Amsterdam: North Holland. pp. 118-161.
5. Green RE, Krause J, Briggs AW, et al. (May 2010). *A draft sequence of the Neandertal genome* (PDF). Science. 328 (5979): 710-722. PMID 20448178. doi:10.1126/science.1188021.
6. Zimmer, Carl (18 December 2013). *Toe Fossil Provides Complete Neandertal Genome*. New York Times. Retrieved 18 December 2013.
7. Prüfer, Kay; et al. (18 December 2013). *The complete genome sequence of a Neanderthal from the Altai Mountains*. Nature. 505: 43-49.
8. Than, Ker (6 May 2010). *Neanderthals, Humans Interbred - First Solid DNA Evidence*. National Geographic Society. Retrieved 9 May 2010.
9. Cohen, Jon (29 June 2007). *Relative Differences: The Myth of 1%* (PDF). AAAS. *Humans and Chimps: Close But Not That Close*. Scientific American. 2006-12-19. Retrieved 2006-12-20.
10. Wong, Kate (1 September 2014). *Tiny Genetic Differences between Humans and Other Primates Pervade the Genome*. Scientific American. Retrieved 12 October 2016.
11. Gibbons, Ann (13 June 2012). *Bonobos Join Chimps as Closest Human Relatives*. Science/AAAS. *Scientists Decode Majority of Neandertal Man's Genome*. Deutsche Welle. 13 February 2009.
12. McGroarty, Patrick (12 February 2009). *Team in Germany maps Neandertal genome*. The Associated Press.
13. Brown, David (March 25, 2010). *DNA from bone shows new human forerunner, and raises array of questions*. Washington Post.
14. Krause J, Fu Q, Good JM, et al. (April 2010). *The complete mitochondrial DNA genome of an unknown hominin from southern Siberia*. Nature. 464 (7290): 894-897. PMID 20336068. doi:10.1038/nature08976.
15. Green, Richard E.; et al. (16 November 2006). *Analysis of one million base pairs of Neandertal DNA* (PDF). Nature. 444 (7117): 330-336. PMID 17108958. doi:10.1038/nature05336.

16. Noonan, James P.; et al. (17 November 2006). *Sequencing and Analysis of Neanderthal Genomic DNA* (PDF). *Science*. 314 (5802): 1113-1118.
17. Krause J, Lalueza-Fox C, Orlando L, et al. (November 2007). *The derived FOXP2 variant of modern humans was shared with Neandertals*. *Curr. Biol.* 17 (21): 1908-1912. PMID 17949978. doi:10.1016/j.cub.2007.10.008.
18. Inman, Mason (12 February 2009). *Neanderthal Genome "First Draft" Unveiled*. National Geographic News.
19. Lynn Yarris (15 November 2006). *Neanderthal Genome Sequencing Yields Surprising Results and Opens a New Door to Future Studies*. Lawrence Berkeley National Laboratory. Retrieved 2009-02-16.
20. Wade, Nicholas (12 February 2009). *Scientists in Germany Draft Neanderthal Genome*. The New York Times. Retrieved 20 May 2010.
21. Wade, Nicholas (6 May 2010). *Signs of Neanderthals Mating With Humans*. The New York Times. Skull discovery suggests location where humans first had sex with Neanderthals
22. Igor V. Ovchinnikov; Anders Götherström; Galina P. Romanova; Vitaliy M. Kharitonov; Kerstin Lidén; William Goodwin (30 March 2000). *Molecular analysis of Neanderthal DNA from the northern Caucasus*. *Letters to Nature*. *Nature* 404. pp. 490-493. doi:10.1038/35006625. Retrieved 13 March 2011.
23. David Leveille (31 August 2012). *Scientists Map An Extinct Denisovan Girl's Genome*
24. . PRI's The World,. Retrieved 31 August 2012.
25. Brown, David (25 March 2010), *DNA from bone shows new human forerunner, and raises array of questions*, Washington Post
26. Krause, Johannes; Fu, Qiaomei; Good, Jeffrey M.; Viola, Bence; Shunkov, Michael V.; Derevianko, Anatoli P. & Pääbo, Svante (2010), *The complete mitochondrial DNA genome of an unknown hominin from southern Siberia*, *Nature*, 464 (7290): 894-897, PMID 20336068, doi:10.1038/nature08976
27. Zimmer, Carl (16 November 2015). *In a Tooth, DNA From Some Very Old Cousins, the Denisovans*. New York Times. Retrieved 16 November 2015.
28. Sawyer, Susanna; Renaud, Gabriel; Viola, Bence; Hublin, Jean-Jacques; Gansauge, Marie-Theres; Shunkov, Michael V.; Derevianko, Anatoly P.; Prüfer, Kay; Kelso, Janet; Pääbo, Svante (11 November 2015). *Nuclear and mitochondrial DNA sequences from two Denisovan individuals*. *PNAS*. Bibcode:2015PNAS..11215696S. doi:10.1073/pnas.1519905112. Retrieved 16 November 2015.
29. Davis, Martin D.; Sigal, Ron; Weyuker, Elaine J. (1994). *Computability, Complexity, and Languages: Fundamentals of Theoretical Computer Science (2nd ed.)*. Boston: Academic Press, Harcourt, Brace. p. 327.

30. Rokach, Lior; Maimon, O. (2008). *Data mining with decision trees: theory and applications*. World Scientific Pub Co Inc. ISBN 978-9812771711.
31. Quinlan, J. R., (1986). *Induction of Decision Trees*. Machine Learning 1: 81-106, Kluwer Academic Publishers
32. Breiman, Leo; Friedman, J. H.; Olshen, R. A.; Stone, C. J. (1984). *Classification and regression trees*. Monterey, CA: Wadsworth & Brooks/Cole Advanced Books & Software. ISBN 978-0-412-04841-8.
33. Friedman, J. H. (1999). Stochastic gradient boosting. Stanford University. Hastie, T., Tibshirani, R., Friedman, J. H. (2001). *The elements of statistical learning : Data mining, inference, and prediction*. New York: Springer Verlag.
34. Breiman, L. (1996). Bagging Predictors. *Machine Learning*, 24: pp. 123-140.
35. Rodriguez, J.J. and Kuncheva, L.I. and Alonso, C.J. (2006), Rotation forest: A new classifier ensemble method, *IEEE Transactions on Pattern Analysis and Machine Intelligence*, 28(10):1619-1630.
36. Rivest, Ron (Nov 1987). *Learning Decision Lists* (PDF). *Machine Learning*. 3 (2): 229-246. doi:10.1023/A:1022607331053.
37. Letham, Ben; Rudin, Cynthia; McCormick, Tyler; Madigan, David (2015). *Interpretable Classifiers Using Rules And Bayesian Analysis: Building A Better Stroke Prediction Model*. *Annals of Applied Statistics*. 9: 1350-1371.
38. Wang, Fulton; Rudin, Cynthia (2015). *Falling Rule Lists* (PDF). *Journal of Machine Learning Research*. 38.
39. Kass, G. V. (1980). *An exploratory technique for investigating large quantities of categorical data*. *Applied Statistics*. 29 (2): 119-127. JSTOR 2986296. doi:10.2307/2986296.
40. Hothorn, T.; Hornik, K.; Zeileis, A. (2006). *Unbiased Recursive Partitioning: A Conditional Inference Framework*. *Journal of Computational and Graphical Statistics*. 15 (3): 651-674. JSTOR 27594202. doi:10.1198/106186006X133933.
41. Strobl, C.; Malley, J.; Tutz, G. (2009). *An Introduction to Recursive Partitioning: Rationale, Application and Characteristics of Classification and Regression Trees, Bagging and Random Forests*. *Psychological Methods*. 14 (4): 323-348. doi:10.1037/a0016973.
42. Rokach, L.; Maimon, O. (2005). *Top-down induction of decision trees classifiers-a survey*. *IEEE Transactions on Systems, Man, and Cybernetics, Part C*. 35 (4): 476-487. doi:10.1109/TSMCC.2004.843247.
43. Witten, Ian; Frank, Eibe; Hall, Mark (2011). *Data Mining*. Burlington, MA: Morgan Kaufmann. pp. 102-103. ISBN 978-0-12-374856-0.

44. Gareth, James; Witten, Daniela; Hastie, Trevor; Tibshirani, Robert (2015). *An Introduction to Statistical Learning*. New York: Springer. p. 315. ISBN 978-1-4614-7137-0.
45. Hyafil, Laurent; Rivest, RL (1976). *Constructing Optimal Binary Decision Trees is NP-complete*. *Information Processing Letters*. 5 (1): 15-17. doi:10.1016/0020-0190(76)90095-8.
46. Murthy S. (1998). Automatic construction of decision trees from data: A multidisciplinary survey. *Data Mining and Knowledge Discovery*
47. Ben-Gal I. Dana A., Shkolnik N. and Singer (2014). *Efficient Construction of Decision Trees by the Dual Information Distance Method* (PDF). *Quality Technology & Quantitative Management (QTQM)*, 11(1), 133-147. *Principles of Data Mining*. 2007.
48. Horváth, Tamás; Yamamoto, Akihiro, eds. (2003). *Inductive Logic Programming*. *Lecture Notes in Computer Science*. 2835.
49. Deng,H.; Runger, G.; Tuv, E. (2011). Bias of importance measures for multi-valued attributes and solutions. *Proceedings of the 21st International Conference on Artificial Neural Networks (ICANN)*. pp. 293-300. <http://citeseer.ist.psu.edu/oliver93decision.html>
50. Papagelis A., Kalles D.(2001). Breeding Decision Trees Using Evolutionary Techniques, *Proceedings of the Eighteenth International Conference on Machine Learning*, p.393-400, June 28-July 01, 2001
51. Barros, Rodrigo C., Basgalupp, M. P., Carvalho, A. C. P. L. F., Freitas, Alex A. (2011). A Survey of Evolutionary Algorithms for Decision-Tree Induction. *IEEE Transactions on Systems, Man and Cybernetics, Part C: Applications and Reviews*, vol. 42, n. 3, p. 291-312, May 2012.
52. Chipman, Hugh A., Edward I. George, and Robert E. McCulloch. *Bayesian CART model search*. *Journal of the American Statistical Association* 93.443 (1998): 935-948.
53. Barros R. C., Cerri R., Jaskowiak P. A., Carvalho, A. C. P. L. F., A bottom-up oblique decision tree induction algorithm. *Proceedings of the 11th International Conference on Intelligent Systems Design and Applications (ISDA 2011)*.

Chapter 7

CLASSIFICATION OF WORDS

7.1 Nouns

Proper nouns (too numerous to be listed here)

People's names and titles

Names for deity, religions, religious followers, and sacred books

Races, nationalities, tribes, and languages

Specific Places like countries, cities, bodies of water, streets, buildings, and parks

Specific organizations

Days of the week, months, and holidays

Brand names of products

Historical periods, well-known events, and documents

Titles of publications and written documents

Common nouns

Living organisms

1. Vegetable

(a) tree (Eng.); Baum (Ger.); arbre (Fr.)

(b) flower (Eng.); Blume (Ger.); fleur (Fr.)

- (c) shrub (Eng.); Strauch (Ger.); arbuste (Fr.)
- (d) grass (Eng.); Gras (Ger.); herbe (Fr.)
- (e) bush (Eng.); Busch (Ger.); buisson (Fr.)
- (f) agricultural crop (Eng.); Landwirtschaft (Ger.); surgir (Fr.)
- (g) algae (Eng.); Algen (Ger.); algues (Fr.)
- (h) plankton (Eng.); Plankton (Ger.); plancton (Fr.)

2. Animal

- (a) people (Eng.); Menschen (Ger.); gens (Fr.)
- (b) man (Eng.); Männer (Ger.); homme (Fr.)
- (c) woman (Eng.); Frau (Ger.); femme (Fr.)
- (d) family (Eng.); Familie (Ger.); famille (Fr.)
- (e) student (Eng.); Schüler (Ger.); étudiant (Fr.)
- (f) hand (Eng.); Hand (Ger.); main (Fr.)
- (g) mother (Eng.); Mutter (Ger.); mère (Fr.)
- (h) father (Eng.); Vater (Ger.); père (Fr.)

Nonliving things

1. Concrete

- (a) world (Eng.); Welt (Ger.); monde (Fr.)
- (b) school (Eng.); Schule (Ger.); école (Fr.)
- (c) state (Eng.); Bundesland (Ger.); état (Fr.)
- (d) country (Eng.); Land (Ger.); pays (Fr.)
- (e) government (Eng.); Regierung (Ger.); gouvernement (Fr.)
- (f) water (Eng.); Wasser (Ger.); eau (Fr.)
- (g) home (Eng.); heimat (Ger.); maison (Fr.)
- (h) room (Eng.); Zimmer (Ger.); chambre (Fr.)
- (i) money (Eng.); Geld (Ger.); argent (Fr.)

2. Abstract

- (a) time (Eng.); Zeit (Ger.); temps (Fr.)
- (b) year (Eng.); Jahr (Ger.); an (Fr.)
- (c) day (Eng.); Tag (Ger.); journée (Fr.)
- (d) way (Eng.); Weg (Ger.); façon (Fr.)
- (e) thing (Eng.); Ding (Ger.); chose (Fr.)
- (f) life (Eng.); Leben (Ger.); la vie (Fr.)
- (g) group (Eng.); Gruppe (Ger.); groupe (Fr.)
- (h) problem (Eng.); Problem (Ger.); problème (Fr.)
- (i) part (Eng.); Teil (Ger.); partie (Fr.)
- (j) place (Eng.); Ort (Ger.); endroit (Fr.)
- (k) case (Eng.); Fall (Ger.); cas (Fr.)
- (l) week (Eng.); Woche (Ger.); la semaine (Fr.)
- (m) company (Eng.); Unternehmen (Ger.); compagnie (Fr.)
- (n) system (Eng.); System (Ger.); système (Fr.)
- (o) question (Eng.); Frage (Ger.); question (Fr.)
- (p) number (Eng.); Nummer (Ger.); nombre (Fr.)
- (q) night (Eng.); Nacht (Ger.); nuit (Fr.)
- (r) point (Eng.); Punkt (Ger.); point (Fr.)
- (s) area (Eng.); Bereich (Ger.); région (Fr.)

7.2 Pronouns

Personal pronouns

Singular personal pronouns

1. I (Eng.); ich (Ger.); je (Fr.)
2. me (Eng.); mich (Ger.); moi (Fr.)
3. you (Eng.); Sie (Ger.); toi (Fr.)
4. she (Eng.); sie (Ger.); elle (Fr.)
5. her (Eng.); ihr (Ger.); sa (Fr.)
6. he (Eng.); er (Ger.); il (Fr.)
7. him (Eng.); ihm (Ger.); lui (Fr.)
8. it (Eng.); es (Ger.); il (Fr.)

Plural personal pronouns

1. we (Eng.); wir (Ger.); nous (Fr.)
2. us (Eng.); uns (Ger.); nous (Fr.)
3. you (Eng.); Sie (Ger.); vous (Fr.)
4. they (Eng.); Sie (Ger.); ils (Fr.)
5. them (Eng.); Sie (Ger.); leur (Fr.)

Possessive pronouns

Singular possessive pronouns

1. my (Eng.); meine (Ger.); mon (Fr.)
2. mine (Eng.); mein (Ger.); mien (Fr.)
3. your (Eng.); Ihre (Ger.); votre (Fr.)
4. yours (Eng.); deine (Ger.); le tiens (Fr.)
5. hers (Eng.); ihres (Ger.); la sienne (Fr.)
6. his (Eng.); seine (Ger.); le sien (Fr.)
7. its (Eng.); seine (Ger.); ses (Fr.)

Plural possessive pronouns

1. yours (Eng.); deine (Ger.); le tiens (Fr.)
2. ours (Eng.); unsere (Ger.); les notres (Fr.)
3. theirs (Eng.); ihre (Ger.); Thiers (Fr.)

Reflexive pronouns

Singular reflexive pronouns

1. myself (Eng.); mich selber (Ger.); moi même (Fr.)
2. yourself (Eng.); dich selber (Ger.); toi même (Fr.)
3. himself (Eng.); selbst (Ger.); lui-même (Fr.)
4. herself (Eng.); Sie selber (Ger.); se (Fr.)
5. itself (Eng.); selbst (Ger.); même (Fr.)

Plural reflexive pronouns

1. ourselves (Eng.); uns selbst (Ger.); nous-mêmes (Fr.)
2. yourselves (Eng.); euch (Ger.); vous-mêmes (Fr.)
3. themselves (Eng.); sich (Ger.); se (Fr.)

Reciprocal pronouns

1. each other (Eng.); gegenseitig (Ger.); l'un et l'autre (Fr.)
2. one another (Eng.); einander (Ger.); un autre (Fr.)

Indefinite pronouns

1. all (Eng.); alle (Ger.); tout (Fr.)
2. another (Eng.); ein anderer (Ger.); un autre (Fr.)
3. any (Eng.); irgendein (Ger.); tout (Fr.)
4. anybody (Eng.); irjemand (Ger.); n'importe qui (Fr.)
5. anyone (Eng.); jemand (Ger.); n'importe qui (Fr.)
6. anything (Eng.); etwas (Ger.); n'importe quoi (Fr.)
7. both (Eng.); beide (Ger.); tous les deux (Fr.)
8. each (Eng.); jede einzelne (Ger.); chaque (Fr.)
9. either (Eng.); entweder (Ger.); non plus (Fr.)
10. everybody (Eng.); jeder (Ger.); tout le monde (Fr.)
11. everyone (Eng.); jeder (Ger.); toutes les personnes (Fr.)
12. everything (Eng.); alles (Ger.); tout (Fr.)
13. few (Eng.); wenige (Ger.); peu (Fr.)
14. many (Eng.); viele (Ger.); beaucoup (Fr.)
15. neither... nor (Eng.); weder... noch (Ger.); ni... ni (Fr.)
16. nobody (Eng.); niemand (Ger.); personne (Fr.)
17. none (Eng.); keiner (Ger.); aucun (Fr.)
18. no one (Eng.); Niemand (Ger.); personne (Fr.)
19. nothing (Eng.); nichts (Ger.); rien (Fr.)
20. one (Eng.); eine (Ger.); un (Fr.)

21. several (Eng.); mehrere (Ger.); nombreuses (Fr.)
22. some (Eng.); etwas (Ger.); certains (Fr.)
23. somebody (Eng.); jemand (Ger.); quelqu'un (Fr.)
24. someone (Eng.); jemand (Ger.); quelqu'un (Fr.)
25. something (Eng.); etwas (Ger.); quelque chose (Fr.)

Demonstrative pronouns

Singular demonstrative pronouns

1. this (Eng.); Dies (Ger.); ce (Fr.)
2. that (Eng.); dass (Ger.); cette (Fr.)

Plural demonstrative pronouns

1. these (Eng.); diese (Ger.); celles-ci (Fr.)
2. those (Eng.); jene (Ger.); ceux (Fr.)

Intrrogative pronouns

1. who (Eng.); wer (Ger.); qui (Fr.)
2. whom (Eng.); wem (Ger.); qui (Fr.)
3. which (Eng.); welche (Ger.); lequel (Fr.)
4. whose (Eng.); deren (Ger.); dont (Fr.)
5. that (Eng.); dass (Ger.); cette (Fr.)

Relative pronouns

1. whoever (Eng.); wer auch immer (Ger.); quiconque (Fr.)
2. whomever (Eng.); wer auch immer (Ger.); quiconque (Fr.)
3. whichever (Eng.); was auch immer (Ger.); selon (Fr.)

7.3 Adjectives

Opinion

1. good (Eng.) gut (Ger.) bon (Fr.)
2. great (Eng.) gross (Ger.) grand (Fr.)
3. other (Eng.) andere (Ger.) autre (Fr.)
4. different (Eng.) anders (Ger.) différent (Fr.)
5. important (Eng.) wichtig (Ger.) important (Fr.)
6. bad (Eng.) schlecht (Ger.) mauvais (Fr.)
7. real (Eng.) echt (Ger.) vrai (Fr.)
8. best (Eng.) beste (Ger.) meilleur (Fr.)
9. right (Eng.) recht (Ger.) bon (Fr.)
10. only (Eng.) einzige (Ger.) seulement (Fr.)
11. early (Eng.) frühe (Ger.) précoce (Fr.)
12. sure (Eng.) sichere (Ger.) sûr (Fr.)
13. able (Eng.) fähige (Ger.) capable (Fr.)
14. late (Eng.) späte (Ger.) tardif (Fr.)
15. hard (Eng.) harte (Ger.) dur (Fr.)
16. major (Eng.) grosse (Ger.) majeur (Fr.)
17. better (Eng.) bessere (Ger.) meilleur (Fr.)

Size

1. high (Eng.) hoch (Ger.) haut (Fr.)
2. big (Eng.) gross (Ger.) grand (Fr.)
3. small (Eng.) klein (Ger.) petit (Fr.)
4. large (Eng.) gross (Ger.) gros (Fr.)
5. long (Eng.) lange (Ger.) long (Fr.)
6. little (Eng.) wenig (Ger.) petit (Fr.)
7. low (Eng.) niedrig (Ger.) bas (Fr.)

Age

1. new (Eng.) neu (Ger.) nouveau (Fr.)
2. old (Eng.) alt (Ger.) vieux (Fr.)
3. young (Eng.) jung (Ger.) jeune (Fr.)

Color

1. black (Eng.) schwarz (Ger.) noir (Fr.)
2. white (Eng.) weiss (Ger.) blanc (Fr.)
3. red (Eng.) rot (Ger.) rouge (Fr.)

Origin

1. American (Eng.) amerikanisch (Ger.) américain (Fr.)
2. national (Eng.) national (Ger.) national (Fr.)
3. political (Eng.) politisch (Ger.) politique (Fr.)
4. social (Eng.) sozial (Ger.) social (Fr.)
5. public (Eng.) öffentliches (Ger.) public (Fr.)
6. human (Eng.) menschliche (Ger.) humain (Fr.)
7. local (Eng.) lokal (Ger.) local (Fr.)

7.4 Verbs**Main verbs**

1. Transitive main verbs

- (a) say (Eng.); sagen (Ger.); dire (Fr.)
- (b) make (Eng.); machen (Ger.); faire (Fr.)
- (c) know (Eng.); wissen (Ger.); connaître (Fr.)
- (d) think (Eng.); denken (Ger.); penser (Fr.)
- (e) take (Eng.); nehmen (Ger.); prendre (Fr.)
- (f) want (Eng.); wollen (Ger.); vouloir (Fr.)
- (g) use (Eng.); benutzen (Ger.); utiliser (Fr.)
- (h) find (Eng.); finden (Ger.); trouver (Fr.)
- (i) give (Eng.); geben (Ger.); donner (Fr.)
- (j) tell (Eng.); sagen (Ger.); dire (Fr.)
- (k) ask (Eng.); Fragen (Ger.); demander (Fr.)
- (l) feel (Eng.); fühlen (Ger.); ressentir (Fr.)
- (m) put (Eng.); stellen (Ger.); mettre (Fr.)
- (n) mean (Eng.); bedeuten (Ger.); vouloir dire (Fr.)
- (o) keep (Eng.); behalten (Ger.); garder (Fr.)
- (p) let (Eng.); lassen (Ger.); laisser (Fr.)
- (q) seem (Eng.); scheinen (Ger.); sembler (Fr.)
- (r) help (Eng.); helfen (Ger.); aider (Fr.)
- (s) show (Eng.); zeigen (Ger.); montrer (Fr.)
- (t) like (Eng.); mögen (Ger.); aimer (Fr.)
- (u) believe (Eng.); glauben (Ger.); croire (Fr.)
- (v) hold (Eng.); halten (Ger.); tenir (Fr.)
- (w) write (Eng.); schreiben (Ger.); écrire (Fr.)
- (x) provide (Eng.); bereitstellen (Ger.); fournir (Fr.)

2. Intransitive main verbs

- (a) look (Eng.); sehen (Ger.); regarder (Fr.)
- (b) work (Eng.); denken (Ger.); travailler (Fr.)
- (c) call (Eng.); anrufen (Ger.); appeler (Fr.)
- (d) need (Eng.); benötigen (Ger.); avoir besoin (Fr.)

- (e) become (Eng.); werden (Ger.); devenir (Fr.)
- (f) leave (Eng.); verlassen (Ger.); partir (Fr.)
- (g) turn (Eng.); drehen (Ger.); tourner (Fr.)
- (h) start (Eng.); anfangen (Ger.); commencer (Fr.)
- (i) play (Eng.); spielen (Ger.); jouer (Fr.)
- (j) move (Eng.); bewegen (Ger.); bouger (Fr.)
- (k) live (Eng.); leben (Ger.); vivre (Fr.)
- (l) happen (Eng.); passieren (Ger.); se passer (Fr.)
- (m) sit (Eng.); sitzen (Ger.); s'asseoir (Fr.)

Auxiliary verbs

1. be (Eng.); zu sein (Ger.); être (Fr.)
2. am (Eng.); bin (Ger.); suis (Fr.)
3. is (Eng.); ist (Ger.); est (Fr.)
4. are (Eng.); sind (Ger.); sont (Fr.)
5. was (Eng.); war (Ger.); était (Fr.)
6. were (Eng.); sind (Ger.); étaient (Fr.)
7. being (Eng.); sein (Ger.); étant (Fr.)
8. been (Eng.); gewesen sein (Ger.); été (Fr.)
9. should (Eng.); sollte (Ger.); devrait (Fr.)
10. could (Eng.); könnte (Ger.); pourrait (Fr.)
11. will (Eng.); wird (Ger.); sera (Fr.)
12. have (Eng.); haben (Ger.); avoir (Fr.)
13. has (Eng.); hat (Ger.); a (Fr.)
14. would (Eng.); würde (Ger.); aurait (Fr.)
15. might (Eng.); könnte (Ger.); pourrait (Fr.)
16. can (Eng.); kann (Ger.); pouvez (Fr.)
17. may (Eng.); kann (Ger.); peux (Fr.)
18. must (Eng.); muss (Ger.); doit (Fr.)
19. shall (Eng.); sollte (Ger.); doit (Fr.)
20. ought (to) (Eng.); sollte (Ger.); doit (Fr.)

7.5 Adverbs

Direction of action

1. up (Eng.) hinauf (Ger.) en haut (Fr.)
2. out (Eng.) aus (Ger.) en dehors (Fr.)
3. back (Eng.) zurück (Ger.) arrière (Fr.)
4. down (Eng.) unten (Ger.) (Fr.)
5. along (Eng.) an (Ger.) le long de (Fr.)
6. about (Eng.) herum (Ger.) sur (Fr.)
7. over (Eng.) hinüber (Ger.) sur (Fr.)

Place of action

1. in (Eng.) hinein (Ger.) dans (Fr.)
2. there (Eng.) dorthin (Ger.) là-bas (Fr.)
3. here (Eng.) hier hin (Ger.) ici (Fr.)
4. on (Eng.) weiter (Ger.) sur (Fr.)
5. where (Eng.) wo (Ger.) où (Fr.)

Qualifying the action

1. so (Eng.) damit (Ger.) alors (Fr.)
2. just (Eng.) einfach (Ger.) juste (Fr.)
3. how (Eng.) wie (Ger.) comment (Fr.)
4. more (Eng.) mehr (Ger.) plus (Fr.)
5. also (Eng.) auch (Ger.) aussi (Fr.)
6. well (Eng.) gut (Ger.) bien (Fr.)
7. only (Eng.) nur (Ger.) seulement (Fr.)
8. very (Eng.) sehr (Ger.) très (Fr.)
9. even (Eng.) sogar (Ger.) même (Fr.)
10. too (Eng.) auch (Ger.) (Fr.)
11. really (Eng.) wirklich (Ger.) vraiment (Fr.)
12. most (Eng.) am meisten (Ger.) les plus (Fr.)
13. why (Eng.) warum (Ger.) pourquoi (Fr.)
14. about (Eng.) darüber (Ger.) à propos de (Fr.)
15. only (Eng.) nur (Ger.) seulement (Fr.)

Speed of action

1. quickly (Eng.) schnell (Ger.) rapidement (Fr.)
2. slowly (Eng.) langsam (Ger.) lentement (Fr.)
3. frequently (Eng.) häufig (Ger.) fréquemment (Fr.)
4. seldom (Eng.) selten (Ger.) rarement (Fr.)

Time of action

1. when (Eng.) wann (Ger.) quand (Fr.)
2. now (Eng.) jetzt (Ger.) maintenant (Fr.)
3. then (Eng.) dann (Ger.) ensuite (Fr.)
4. still (Eng.) immer noch (Ger.) toujours (Fr.)
5. as (Eng.) wie (Ger.) comme (Fr.)
6. never (Eng.) niemals (Ger.) jamais (Fr.)
7. always (Eng.) immer (Ger.) toujours (Fr.)

8. again (Eng.) nochmals (Ger.) encore (Fr.)
9. today (Eng.) heute (Ger.) aujourd'hui (Fr.)
10. often (Eng.) oft (Ger.) souvent (Fr.)
11. later (Eng.) später (Ger.) plus tard (Fr.)
12. once (Eng.) einmal (Ger.) une fois (Fr.)

7.6 Conjunctions

Coordinating conjunctions

1. for (Eng.); für (Ger.); pour (Fr.)
2. and (Eng.); und (Ger.); et (Fr.)
3. nor (Eng.); noch (Ger.); ni (Fr.)
4. but (Eng.); aber (Ger.); mais (Fr.)
5. or (Eng.); oder (Ger.); ou (Fr.)
6. yet (Eng.); noch (Ger.); encore (Fr.)
7. so (Eng.); damit (Ger.); alors (Fr.)

Correlative conjunctions

1. both... and (Eng.); sowohl... und (Ger.); et (Fr.)
2. neither... nor (Eng.); weder... noch (Ger.); ni... ni (Fr.)
3. whether... or (Eng.); ob... oder (Ger.); si... ou (Fr.)
4. either... or (Eng.); entweder... oder (Ger.); soit... ou (Fr.)
5. not only... but also (Eng.); nicht nur... sondern auch (Ger.); pas seulement... mais aussi (Fr.)

7.7 Prepositions

1. about (Eng.); worüber (Ger.); sur (Fr.)
2. above (Eng.); über (Ger.); au dessus (Fr.)
3. across (Eng.); über (Ger.); à travers (Fr.)
4. after (Eng.); nach (Ger.); après (Fr.)
5. among (Eng.); unter (Ger.); parmi (Fr.)
6. around (Eng.); um (Ger.); autour (Fr.)
7. at (Eng.); beim (Ger.); à (Fr.)
8. before (Eng.); vor (Ger.); avant (Fr.)
9. behind (Eng.); hinter (Ger.); derrière (Fr.)
10. below (Eng.); unten (Ger.); au dessous de (Fr.)
11. beneath (Eng.); unter (Ger.); sous (Fr.)

12. beside (Eng.); neben (Ger.); à côté de (Fr.)
13. between (Eng.); zwischen (Ger.); entre (Fr.)
14. by (Eng.); am (Ger.); par (Fr.)
15. down (Eng.); runter (Ger.); vers le bas (Fr.)
16. during (Eng.); während (Ger.); pendant (Fr.)
17. except (Eng.); ausser (Ger.); sauf (Fr.)
18. from (Eng.); von (Ger.); de (Fr.)
19. instead (Eng.); stattdessen (Ger.); au lieu (Fr.)
20. into (Eng.); in (Ger.); dans (Fr.)
21. like (Eng.); wie (Ger.); comme (Fr.)
22. of (Eng.); von (Ger.); de (Fr.)
23. on (Eng.); auf (Ger.); sur (Fr.)
24. in (Eng.); in (Ger.); dans (Fr.)
25. through (Eng.); durch (Ger.); par (Fr.)
26. to (Eng.); zu (Ger.); à (Fr.)
27. toward (Eng.); zum (Ger.); vers (Fr.)
28. off (Eng.); aus (Ger.); hors (Fr.)
29. over (Eng.); über (Ger.); plus de (Fr.)
30. since (Eng.); seit (Ger.); depuis (Fr.)
31. under (Eng.); unter (Ger.); en dessous de (Fr.)
32. with (Eng.); mit (Ger.); avec (Fr.)
33. without (Eng.); ohne (Ger.); sans (Fr.)

7.8 Interjections

1. Oh! (Eng.); Oh! (Ger.); Oh! (Fr.)
2. Wow! (Eng.); Beeindruckend! (Ger.); Hou la la! (Fr.)
3. Ouch! (Eng.); Autsch! (Ger.); Aie! (Fr.)
4. Oops! (Eng.); Hoppla! (Ger.); Oops! (Fr.)
5. Hey! (Eng.); Hallo! (Ger.); Hey! (Fr.)

7.9 Articles

1. the (Eng.); das (Ger.); la (Fr.)
2. a (Eng.); ein (Ger.); une (Fr.)
3. and (Eng.); und (Ger.); et (Fr.)
4. an (Eng.); ein (Ger.); un (Fr.)

Chapter 8

SOME CONCLUDING REMARKS

8.1 Can invented languages be pronounced?

8.2 The evolution of consciousness

Umwelt

Jakob von Uexküll (1864-1944), was born in Estonia, and studied zoology at the University of Tartu. After graduation, he worked at the Institute of Physiology at the University of Heidelberg, and later at the Zoological Station in Naples. In 1907, he was given an honorary doctorate by Heidelberg for his studies of the physiology of muscles. Among his discoveries in this field was the first recognized instance of negative feedback in an organism. Von Uexküll's later work was concerned with the way in which animals experience the world around them. To describe the animal's subjective perception of its environment he introduced the word Umwelt; and in 1926 he founded the Institut für Umweltforschung at the University of Heidelberg. Von Uexküll visualized an animal - for example a mouse - as being surrounded by a world of its own - the world conveyed by its own special senses organs, and processed by its own interpretative systems. Obviously, the Umwelt will differ greatly depending on the organism. For example, bees are able to see polarized light and ultraviolet light; electric eels are able to sense their environment through their electric organs; many insects are extraordinarily sensitive to pheromones; and a dog's Umwelt far richer in smells than that of most other animals. The Umwelt of a jellyfish is very simple, but nevertheless it exists. It is interesting to ask to what extent the concept of Umwelt can be equated to that of consciousness. To the extent that these two concepts can be equated, von Uexküll's Umwelt-

forschung offers us the opportunity to explore the phylogenetic evolution of the phenomenon of consciousness. Von Uexküll's Umwelt concept can even extend to one-celled organisms, which receive chemical and tactile signals from their environment, and which are often sensitive to light. The ideas and research of Jakob von Uexküll inspired the later work of the Nobel Laureate ethologist Konrad Lorenz, and thus von Uexküll can be thought of as one of the founders of ethology as well as of biosemiotics. Indeed, ethology and biosemiotics are closely related.

8.3 Dreaming and intelligence

I remember an occasion about thirty years ago, when I was having lunch with several friends at the Niels Bohr Institute in Copenhagen. Among them was the distinguished theoretical physicist, Prof. Benny Lattstrup, who, in addition to his work in physics, was also interested in writing computer programs that would duplicate some of the functions of the human brain. I happened to ask him whether he thought that computers would ever dream. Everyone else at the table was greatly amused, and they told me that I had just asked Benny his favorite question. I prepared myself for a long lecture, which indeed followed.

Benny Lattstrup first gave me a simple answer: "Of course computers will one day dream! They have to dream in order to be truly intelligent." He then explained that if one makes a plot of brain size versus intelligence for various animals on the evolutionary scale, the plot at the lowest end rises monotonically in a smooth way until a certain point. Then, suddenly, there is a large upward jump, after which the plot again rises smoothly and monotonically.

What was the significance of this sudden upward jump in the brain size versus intelligence graph? Benny Lattstrup explained that this was the point in evolutionary history when brains became capable of dreaming. But what is dreaming? The lecture continued: Dreaming is a process in which our brains transfer the impressions which we received during the day from our temporary memories to our permanent memory system. But where should the memories be stored? What patterns of association should be established? Many possibilities are explored and rejected before appropriate associations are found and permanent connections made.

8.4 The information explosion

8.5 Agriculture

Acceleration of human cultural evolution

In the caves of Spain and southern France are the remains of vigorous hunting cultures which flourished between 30,000 and 10,000 years ago. The people of these upper paleolithic cultures lived on the abundant cold-weather game which roamed the southern edge of the ice sheets during the Wurm glacial period: huge herds of reindeer, horses and wild cattle, as well as mammoths and woolly rhinos. The paintings found in the Dordogne region of France, for example, combine decorative and representational elements in a manner which contemporary artists might envy. Sometimes among the paintings are stylized symbols which can be thought of as the first steps towards writing.

In this period, not only painting, but also tool-making and weapon-making were highly developed arts. For example, the Solutrian culture, which flourished in Spain and southern France about 20,000 years ago, produced beautifully worked stone lance points in the shape of laurel leaves and willow leaves. The appeal of these exquisitely pressure-flaked blades must have been aesthetic as well as functional. The people of the Solutrian culture had fine bone needles with eyes, bone and ivory pendants, beads and bracelets, and long bone pins with notches for arranging the hair. They also had red, yellow and black pigments for painting their bodies. The Solutrian culture lasted for 4,000 years. It ended in about 17,000 B.C. when it was succeeded by the Magdalenian culture. Whether the Solutrian people were conquered by another migrating group of hunters, or whether they themselves developed the Magdalenian culture we do not know.

Beginning about 10,000 B.C., the way of life of the hunters was swept aside by a great cultural revolution: the invention of agriculture. The earth had entered a period of unusual climatic stability, and this may have helped to make agriculture possible. The first agricultural villages date from this time, as well as the earliest examples of pottery. Dogs and reindeer were domesticated, and later, sheep and goats. Radio-carbon dating shows that by 8,500 B.C., people living in the caves of Shanidar in the foothills of the Zagros mountains in Iran had domesticated sheep. By 7,000 B.C., the village farming community at Jarmo in Iraq had domesticated goats, together with barley and two different kinds of wheat.

Starting about 8000 B.C., rice came under cultivation in East Asia. This may represent an independent invention of agriculture, and agriculture may also have been invented independently in the western hemisphere, made pos-

sible by the earth's unusually stable climate during this period. At Jericho, in the Dead Sea valley, excavations have revealed a prepottery neolithic settlement surrounded by an impressive stone wall, six feet wide and twelve feet high. Radiocarbon dating shows that the defenses of the town were built about 7,000 B.C. Probably they represent the attempts of a settled agricultural people to defend themselves from the plundering raids of less advanced nomadic tribes.

8.6 Writing

The Egyptian hieroglyphic (priest writing) system began its development in about 4,000 B.C.. At that time, it was pictorial rather than phonetic. However, the Egyptians were in contact with the Sumerian civilization of Mesopotamia, and when the Sumerians developed a phonetic system of writing in about 3,100 B.C., the Egyptians were quick to adopt the idea. In the cuneiform writing of the Sumerians, a character stood for a syllable. In the Egyptian adaptation of this idea, most of the symbols stood for combinations of two consonants, and there were no symbols for vowels. However, a few symbols were purely alphabetic, i.e. they stood for sounds which we would now represent by a single letter. This was important from the standpoint of cultural history, since it suggested to the Phoenicians the idea of an alphabet of the modern type.

In Sumer, the pictorial quality of the symbols was lost at a very early stage, so that in the cuneiform script the symbols are completely abstract. By contrast, the Egyptian system of writing was designed to decorate monuments and to be impressive even to an illiterate viewer; and this purpose was best served by retaining the elaborate pictographic form of the symbols.

The ancient Egyptians were the first to make books. As early as 4,000 B.C., they began to make books in the form of scrolls by cutting papyrus reeds into thin strips and pasting them into sheets of double thickness. The sheets were glued together end to end, so that they formed a long roll. The rolls were sometimes very long indeed. For example, one roll, which is now in the British Museum, is 17 inches wide and 135 feet long.

(Paper of the type which we use today was not invented until 105 A.D.. This enormously important invention was made by a Chinese eunuch named Tsai Lun. The kind of paper invented by Tsai Lun could be made from many things: for example, bark, wood, hemp, rags, etc.. The starting material was made into a pulp, mixed together with water and binder, spread out on a cloth to partially dry, and finally heated and pressed into thin sheets. The art of paper-making spread slowly westward from China, reaching Baghdad in 800 A.D.. It was brought to Europe by the crusaders returning from the

Middle East. Thus paper reached Europe just in time to join with Gutenberg's printing press to form the basis for the information explosion which has had such a decisive effect on human history.)

8.7 Printing

It was during the T'ang period that the Chinese made an invention of immense importance to the cultural evolution of mankind. This was the invention of printing. Together with writing, printing is one of the key inventions which form the basis of human cultural evolution.

Printing was invented in China in the 8th or 9th century A.D., probably by Buddhist monks who were interested in producing many copies of the sacred texts which they had translated from Sanscrit. The act of reproducing prayers was also considered to be meritorious by the Buddhists.

The Chinese had for a long time followed the custom of brushing engraved official seals with ink and using them to stamp documents. The type of ink which they used was made from lamp-black, water and binder. In fact, it was what we now call "India ink". However, in spite of its name, India ink is a Chinese invention, which later spread to India, and from there to Europe. We mentioned that paper of the type which we now use was invented in China in the first century A.D.. Thus, the Buddhist monks of China had all the elements which they needed to make printing practical: They had good ink, cheap, smooth paper, and the tradition of stamping documents with ink-covered engraved seals. The first block prints which they produced date from the 8th century A.D.. They were made by carving a block of wood the size of a printed page so that raised characters remained, brushing ink onto the block, and pressing this onto a sheet of paper.

The unsuitability of the Chinese written language for the use of movable type was the greatest tragedy of the Chinese civilization. Writing had been developed at a very early stage in Chinese history, but the system remained a pictographic system, with a different character for each word. A phonetic system of writing was never developed.

The failure to develop a phonetic system of writing had its roots in the Chinese imperial system of government. The Chinese empire formed a vast area in which many different languages were spoken. It was necessary to have a universal language of some kind in order to govern such an empire. The Chinese written language solved this problem admirably. Thus it was left to Gutenberg in Germany to fully exploit the possibilities of printing with movable type.

8.8 An explosion of industry

The development of printing in Europe produced a brilliant, chainlike series of scientific discoveries. During the 17th century, the rate of scientific progress gathered momentum, and in the 18th and 19th centuries, the practical applications of scientific knowledge revolutionized the methods of production in agriculture and industry.

The changes produced by the industrial revolution at first resulted in social chaos - enormous wealth in some classes of society, and great suffering in other classes; but later, after the appropriate social and political adjustments had been made, the improved methods of production benefited all parts of society in a more even way.

The Industrial Revolution marked the start of massive human use of fossil fuels. The stored energy from several hundred million years of plant growth began to be used at roughly a million times the rate at which it had been formed. The effect on human society was like that of a narcotic. There was a euphoric (and totally unsustainable) surge of growth of both population and industrial production. Meanwhile, the carbon released into the atmosphere from the burning of fossil fuels began to duplicate the conditions which led to the 5 geologically-observed mass extinctions, during each of which more than half of all living species disappeared forever.

8.9 An explosion of communication

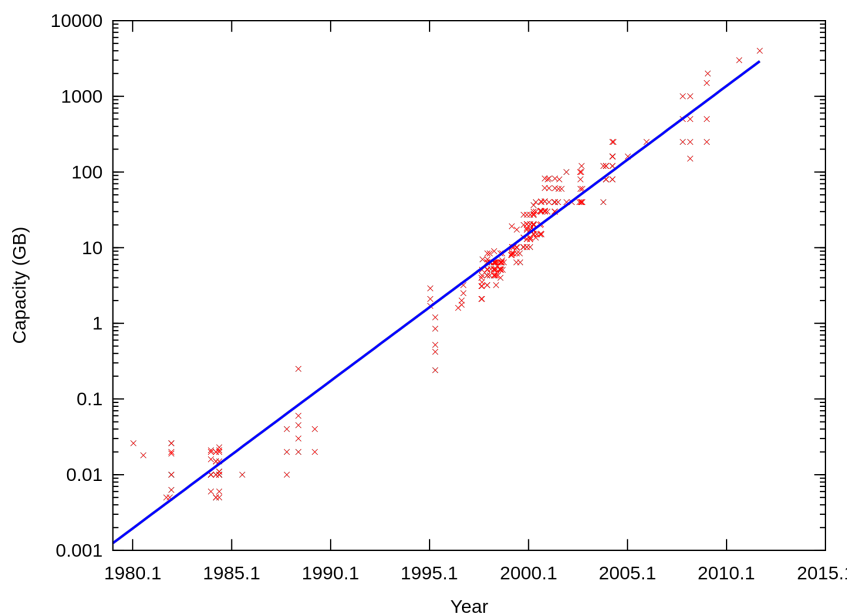

Figure 8.2: A logarithmic plot of the increase in PC hard-drive capacity in gigabytes. An extrapolation of the rate of increase predicts that the individual capacity of a commercially available PC will reach 10,000 gigabytes by 2015, i.e. 10,000,000,000,000 bytes. (After Hankwang and Rentar, Wikimedia Commons)

8.10 An explosion of population

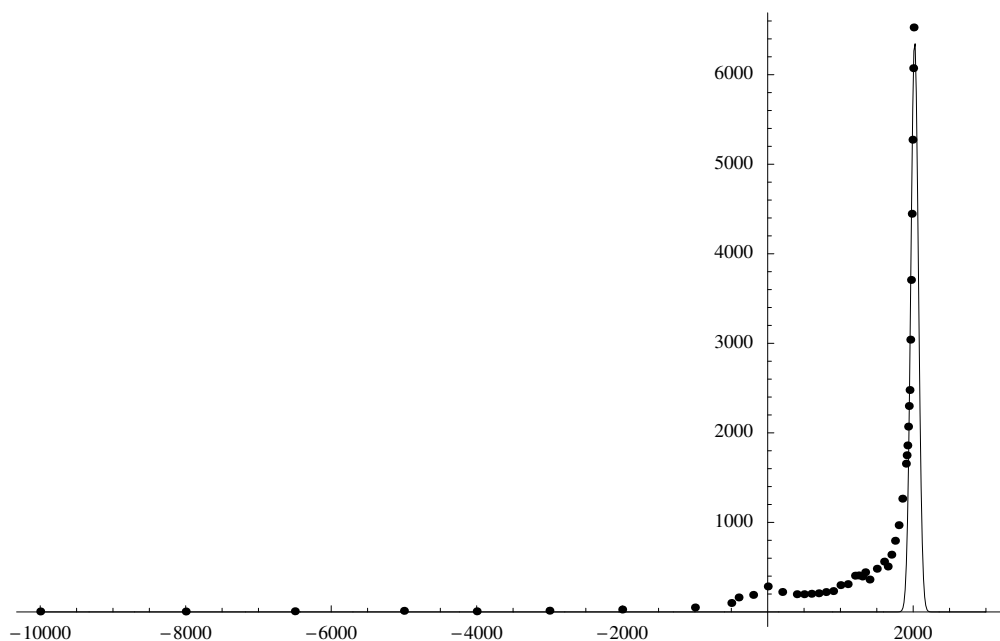

Figure 8.3: When plotted over a period of several thousand years, the historical and predicted human consumption of fossil fuels appears as a sharp spike, rising from almost nothing to a high value in a few centuries, and then rapidly falling to almost nothing. If we plot human population on the same graph, we see that the two curves rise sharply and simultaneously, indicating that the human population explosion may have been partially driven by the consumption of fossil fuels. This raises the disturbing question of whether population will crash when fossil fuels are exhausted.

8.11 Paradox

Today, human greed and folly are destroying the global environment. As if this were not enough, there is a great threat to civilization and the biosphere from an all-destroying thermonuclear war. Both of these severe existential threats are due to faults our inherited emotional nature.

From the standpoint of evolutionary theory, this is a paradox. As a species, we are well on the road to committing collective suicide, driven by the flaws in human nature. But isn't natural selection supposed to produce traits that lead to survival? Today, our emotions are not leading us towards survival, but instead driving us towards extinction. What is the reason for this paradox?

Our emotions have an extremely long evolutionary history. Both lust and rage are emotions that we share with many animals. However, with the rapid advance of human cultural evolution, our ancestors began to live together in progressively larger groups, and in these new societies, our inherited emotional nature was often inappropriate. What once was a survival trait became a sin which needed to be suppressed by morality and law. Today we live in a world that is entirely different from the one into which our species was born. Today we are threatened with exploding populations, vanishing resources, and the twin threats of catastrophic climate change and thermonuclear war. We face these severe problems with our poor cave-man's brain, with an emotional nature that has not changed much since our ancestors lived in small tribes, competing for territory on the grasslands of Africa.

On aggression

The Nobel laureate ethologist Konrad Lorenz is best known for his controversial book *On Aggression*. In this book, Lorenz makes a distinction between intergroup aggression and intragroup aggression. Among animals, he points out, rank-determining fights are seldom fatal. Thus, for example, the fights that determine leadership within a wolf pack end when the loser makes a gesture of submission. By contrast, fights between groups of animals are often fights to the death, examples being wars between ant colonies, or of bees against intruders, or the defense of a rat pack against strange rats.

Many animals, humans included, seem willing to kill or be killed in defense of the communities to which they belong. Lorenz calls this behavioral tendency a "communal defense response". He points out that the "holy shiver", the tingling of the spine that humans experience when performing an heroic act in defense of their communities, is related to the prehuman reflex for raising the hair on the back of an animal as it confronts an enemy, a reflex that makes the animal seem larger than it really is.

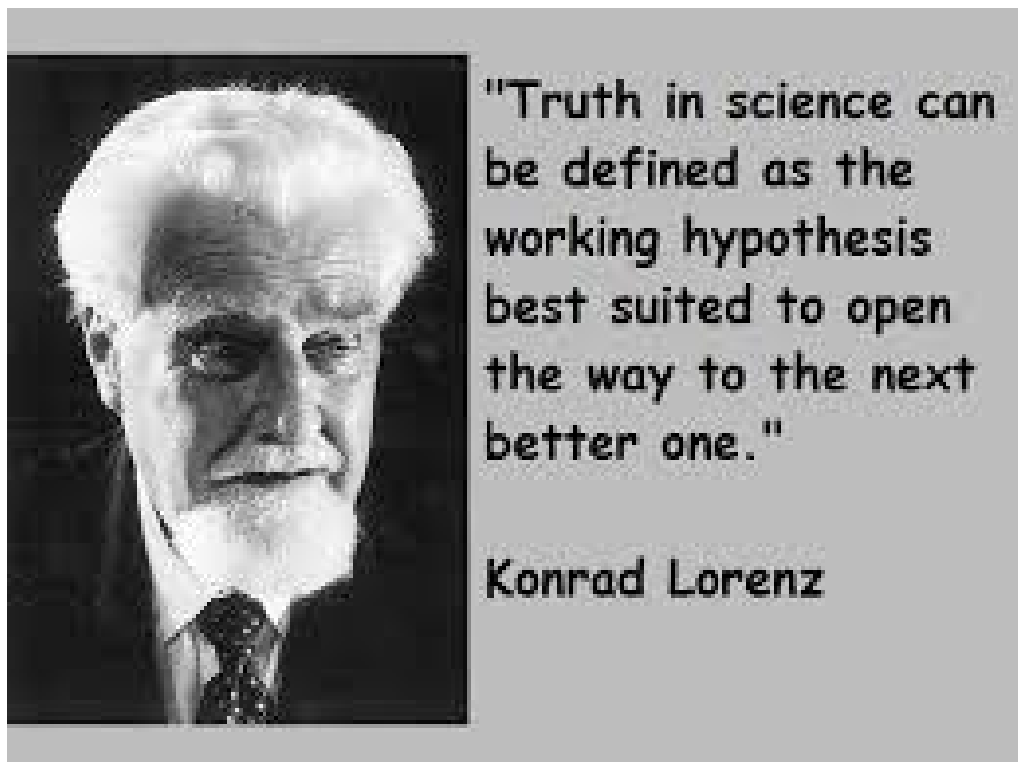

Figure 8.4: *Konrad Lorenz.*



Figure 8.5: *Professor E.O. Wilson of Harvard is famous for his books on Sociobiology.*



Figure 8.6: *Professor Richard Dawkins of Oxford, controversial author of “The Selfish Gene” and many other books. He has contributed much to the debate on relationships between science, religion, aggression and altruism.*

Many of the great ethical teachers of history lived at a time when cultural evolution was changing humans from hunter-gatherers and pastoral peoples to farmers and city dwellers. To live and cooperate in larger groups, humans needed to overwrite their instinctive behavior patterns with culturally determined behavior involving a wider range of cooperation than previously.

This period of change is marked by the lives and ideas of a number of great ethical teachers - Moses, Buddha, Lao Tse, Confucius, Socrates, Aristotle, Jesus, and Saint Paul. Mohammed lived at a slightly later period, but it was still a period of transition for the Arab peoples, a period during which their range cooperation needed to be enlarged.

Most of the widely practiced religions of today contain the principle of universal human brotherhood. This is contained, for example, in Christianity, in the Sermon on the Mount and in the Parable of the Good Samaritan. The Sermon on the Mount tells us that we must love our neighbor as much as we love ourselves. When asked "But who is my neighbor?", Jesus replied with the Parable of the Good Samaritan, which says that our neighbor may belong to a different ethnic group than ourselves, or may be separated from us by geographical distance. Nevertheless, he is still our neighbor and he still deserves our love and assistance. To this, Christianity adds that we must love and forgive our enemy, and do good to those who persecute us, a principle that would make war impossible if it were only followed. Not only in Christianity, but also in Hinduism, Buddhism, and Islam, the principles of compassion and universal human brotherhood hold a high place.

The crisis of civilization, which we face today, has been produced by the rapidity with which science and technology have developed. Our institutions and ideas adjust too slowly to the change. The great challenge which history has given to our generation is the task of building new international political structures, which will be in harmony with modern technology. At the same time, we must develop a new global ethic, which will replace our narrow loyalties by loyalty to humanity as a whole.

Tribal markings; ethnicity; pseudospeciation

In biology, a species is defined to be a group of mutually fertile organisms. Thus all humans form a single species, since mixed marriages between all known races will produce children, and subsequent generations in mixed marriages are also fertile. However, although there is never a biological barrier to marriages across ethnic and racial boundaries, there are often very severe cultural barriers.

Irenäus Eibl-Eibesfeldt, a student of Konrad Lorenz, introduced the word *pseudospeciation* to denote cases where cultural barriers between two groups



Figure 8.7: *Scars help to establish tribal identity*

of humans are so strongly marked that marriages across the boundary are difficult and infrequent. In such cases, he pointed out, the two groups function as though they were separate species, although from a biological standpoint this is nonsense. When two such groups are competing for the same land, the same water, the same resources, and the same jobs, the conflicts between them can become very bitter indeed. Each group regards the other as being “not truly human”.

In his book *The Biology of War and Peace*, Eibl-Eibesfeldt discusses the “tribal markings” used by groups of humans to underline their own identity and to clearly mark the boundary between themselves and other groups. One of the illustrations in the book shows the marks left by ritual scarification on the faces of the members of certain African tribes. These scars would be hard to counterfeit, and they help to establish and strengthen tribal identity. Seeing a photograph of the marks left by ritual scarification on the faces of African tribesmen, it is impossible not to be reminded of the dueling scars that Prussian army officers once used to distinguish their caste from outsiders.

Surveying the human scene, one can find endless examples of signs that mark the bearer as a member of a particular group - signs that can be thought



Figure 8.8: *An example of the dueling scars that Prussian army officers once used to distinguish their caste from outsiders.*

of as “tribal markings”: tattoos; piercing; bones through the nose or ears; elongated necks or ears; filed teeth; Chinese binding of feet; circumcision, both male and female; unique hair styles; decorations of the tongue, nose, or naval; peculiarities of dress, fashions, veils, chadors, and headdresses; caste markings in India; use or nonuse of perfumes; codes of honor and value systems; traditions of hospitality and manners; peculiarities of diet (certain foods forbidden, others preferred); giving traditional names to children; knowledge of dances and songs; knowledge of recipes; knowledge of common stories, literature, myths, poetry or common history; festivals, ceremonies, and rituals; burial customs, treatment of the dead and ancestor worship; methods of building and decorating homes; games and sports peculiar to a culture; relationship to animals, knowledge of horses and ability to ride; nonrational systems of belief. Even a baseball hat worn backwards or the professed ability to enjoy atonal music can mark a person as a member of a special “tribe”. Undoubtedly there many people in New York who would never think of marrying someone who could not appreciate the the paintings of Jasper Johns, and many in London who would consider anyone had not read all the books of Virginia Wolfe to be entirely outside the bounds of civilization.

By far the most important mark of ethnic identity is language, and within a particular language, dialect and accent. If the only purpose of language were communication, it would be logical for the people of a small country like Denmark to stop speaking Danish and go over to a more universally-understood international language such as English. However, language has another function in addition to communication: It is also a mark of identity. It establishes the boundary of the group.

Within a particular language, dialects and accents mark the boundaries of subgroups. For example, in England, great social significance is attached to accents and diction, a tendency that George Bernard Shaw satirized in his play, *Pygmalion*, which later gained greater fame as the musical comedy, *My Fair Lady*. This being the case, we can ask why all citizens of England do not follow the example of Eliza Doolittle in Shaw’s play, and improve their social positions by acquiring Oxford accents. However, to do so would be to run the risk of being laughed at by one’s peers and regarded as a traitor to one’s own local community and friends. School children everywhere can be very cruel to any child who does not fit into the local pattern. At Eton, an Oxford accent is compulsory; but in a Yorkshire school, a child with an Oxford accent would suffer for it.

Next after language, the most important “tribal marking” is religion. As mentioned above, it seems probable that in the early history of our hunter-gatherer ancestors, religion evolved as a mechanism for perpetuating tribal traditions and culture. Like language, and like the innate facial expressions



Figure 8.9: *Audrey Hepburn in the role of Shaw's heroine, Eliza Doolittle.*

studied by Darwin, religion is a universal characteristic of all human societies. All known races and cultures practice some sort of religion. Thus a tendency to be religious seems to be built into human nature, or at any rate, the needs that religion satisfies seem to be a part of our inherited makeup. Otherwise, religion would not be so universal as it is.

Religion is often strongly associated with ethnicity and nationalism, that is to say, it is associated with the demarcation of a particular group of people by its culture or race. For example, the Jewish religion is associated with Zionism and with Jewish nationalism. Similarly Islam is strongly associated with Arab nationalism. Christianity too has played an important role in many aggressive wars, for example in the Crusades, in the European conquest of the New World, in European colonial conquests in Africa and Asia, and in the wars between Catholics and Protestants within Europe. We shall see in a later chapter how the originators of the German nationalist movement (the precursors of the Nazis), used quasi-religious psychological methods.

Human history seems to be saturated with blood. It would be impossible to enumerate the conflicts with which the story of humankind is stained. Many of the atrocities of history have involved what Irenäus Eibl-Eibesfeldt called "pseudospeciation", that is to say, they were committed in conflicts involving groups between which sharply marked cultural barriers have made intermarriage difficult and infrequent. Examples include the present conflict between Israelis and Palestinians; "racial cleansing" in Kosovo; the devastating wars between Catholics and Protestants in Europe; the Lebanese civil war; genocide committed against Jews and Gypsies during World War II; recent genocide in Rwanda; current intertribal massacres in the Ituri Province of Congo; use of poison gas against Kurdish civilians by Saddam Hussein's regime in Iraq; the

massacre of Armenians by Turks; massacres of Hindus by Muslims and of Muslims by Hindus in post-independence India; massacres of Native Americans by white conquerors and settlers in all parts of the New World; and massacres committed during the Crusades. The list seems almost endless.

Religion often contributes to conflicts by sharpening the boundaries between ethnic groups and by making marriage across those boundaries difficult and infrequent. However, this negative role is balanced by a positive one, whenever religion is the source of ethical principles, especially the principle of universal human brotherhood.

The religious leaders of today's world have the opportunity to contribute importantly to the solution of the problem of war. They have the opportunity to powerfully support the concept of universal human brotherhood, to build bridges between religious groups, to make intermarriage across ethnic boundaries easier, and to soften the distinctions between communities. If they fail to do this, they will have failed humankind at a time of crisis.

We started this chapter by saying that human nature is an evolutionary paradox because natural selection is supposed to produce traits that lead to survival, but today our emotions are driving humanity towards destruction. The explanation for this paradox is the enormous and constantly accelerating speed of cultural evolution, especially scientific and technological advances. Genetic evolution is completely unable to keep up with this astonishing rate of change, which might be called an information explosion. Fortunately, human behavior is very malleable, and we can hope that it will be possible to adapt to the rapidly changing conditions of life if proper use is made of our almost miraculous modern communications technologies.

8.12 Culture

Culture, Education and human solidarity

Cultural and educational activities have a small ecological footprint, and therefore are more sustainable than pollution-producing, fossil-fuel-using jobs in industry. Furthermore, since culture and knowledge are shared among all nations, work in culture and education leads societies naturally towards internationalism and peace.

Economies based on a high level of consumption of material goods are unsustainable and will have to be abandoned by a future world that renounces the use of fossil fuels in order to avoid catastrophic climate change, a world where non-renewable resources such as metals will become increasingly rare and expensive. How then can full employment be maintained?

The creation of renewable energy infrastructure will provide work for a large number of people; but in addition, sustainable economies of the future will need to shift many workers from jobs in industry to jobs in the service sector. Within the service sector, jobs in culture and education are particularly valuable because they will help to avoid the disastrous wars that are currently producing enormous human suffering and millions of refugees, wars that threaten to escalate into an all-destroying global thermonuclear war.¹

Human nature has two sides: It has a dark side, to which nationalism and militarism appeal; but our species also has a genius for cooperation, which we can see in the growth of culture. Our modern civilization has been built up by means of a worldwide exchange of ideas and inventions. It is built on the achievements of many ancient cultures. China, Japan, India, Mesopotamia, Egypt, Greece, the Islamic world, Christian Europe, and the Jewish intellectual traditions all have contributed. Potatoes, corn, squash, vanilla, chocolate, chilli peppers, and quinine are gifts from the American Indians.²

We need to reform our educational systems, particularly the teaching of history. As it is taught today, history is a chronicle of power struggles and war, told from a biased national standpoint. We are taught that our own country is always heroic and in the right. We urgently need to replace this indoctrination in chauvinism by a reformed view of history, where the slow development of human culture is described, giving credit to all who have contributed. When we teach history, it should not be about power struggles. It should be about how human culture was gradually built up over thousands of years by the patient work of millions of hands and minds. Our common global culture, the music, science, literature and art that all of us share, should be presented as a precious heritage - far too precious to be risked in a thermonuclear war.

We have to extend our loyalty to the whole of the human race, and to work for a world not only free from nuclear weapons, but free from war. A war-free world is not utopian but very practical, and not only practical but necessary. It is something that we can achieve and must achieve. Today there are large regions, such as the European Union, where war would be inconceivable. What is needed is to extend these.

Nor is a truly sustainable economic system utopian or impossible. To achieve it, we should begin by shifting jobs to the creation of renewable energy infrastructure, and to the fields of culture and education. By so doing we will support human solidarity and avoid the twin disasters of catastrophic war and climate change.

¹<http://www.fredsakademiet.dk/library/need.pdf>
<http://eruditio.worldacademy.org/issue-5/article/urgent-need-renewable-energy>

²<http://eruditio.worldacademy.org/article/evolution-cooperation>

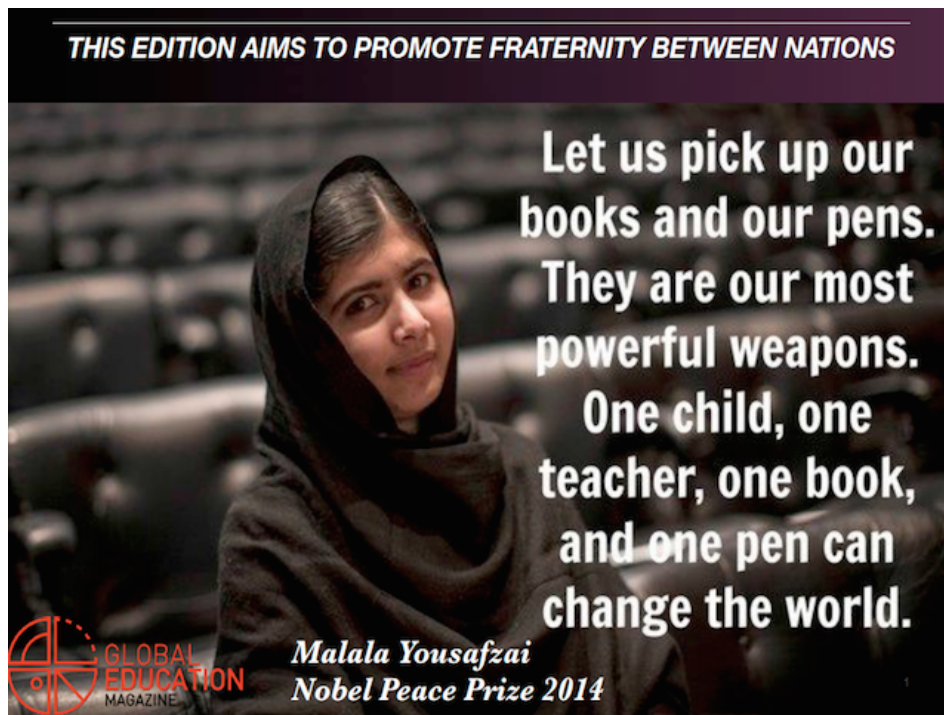

Suggestions for further reading

1. J. Hoffmeyer, *Some semiotic aspects of the psycho-physical relation: the endo-exosemiotic boundary*, in Biosemiotics. The Semiotic Web, T.A. Sebeok and J. Umiker-Sebeok, editors, Mouton de Gruyter, Berlin/New York, (1991).
2. J. Hoffmeyer, *The swarming cyberspace of the body*, Cybernetics and Human Knowing, **3(1)**, 1-10 (1995).
3. J. Hoffmeyer, *Signs of Meaning in the Universe*, Indiana University Press, Bloomington IN, (1996).
4. J. Hoffmeyer, *Biosemiotics: Towards a new synthesis in biology*, European J. Semiotic Stud. **9(2)**, 355-376 (1997).
5. J. Hoffmeyer and C. Emmeche, *Code-duality and the semiotics of nature*, in On Semiotic Modeling, M. Anderson and F. Merrell, editors, Mouton de Gruyter, New York, (1991).
6. C. Emmeche and J. Hoffmeyer, *From language to nature - The semiotic metaphor in biology*, Semiotica, **84**, 1-42 (1991).
7. C. Emmeche, *The biosemiotics of emergent properties in a pluralist ontology*, in Semiosis, Evolution, Energy: Towards a Reconceptualization of the Sign, E. Taborsky, editor, Shaker Verlag, Aachen, (1999).
8. S. Brier, *Information and consciousness: A critique of the mechanistic concept of information*, in Cybernetics and Human Knowing, **1(2/3)**, 71-94 (1992).
9. S. Brier, *Ciber-Semiotics: Second-order cybernetics and the semiotics of C.S. Peirce*, Proceedings from the Second European Congress on System Science, Prague, October 5-8, 1993, AFCET, (1993).
10. S. Brier, *A cybernetic and semiotic view on a Galilean theory of psychology*, Cybernetics and Human Knowing, **2 (2)**, 31-46 (1993).
11. S. Brier, *Cybersemiotics: A suggestion for a transdisciplinary framework for description of observing, anticipatory, and meaning producing systems*, in D.M. Dubois, editor, Computing Anticipatory Systems, CASYS - First International Conference, Liege, Belgium 1997, AIP Conference Proceedings no. 437, (1997).
12. S. Oyama, *The Ontogeny of Information*, Cambridge University Press, (1985).
13. J. Hoffmeyer, *The swarming cyberspace of the body*, Cybernetics and Human Knowing, **3(1)**, 1-10 (1995).
14. J.L. Casti and A. Karlqvist, editors, *Complexity, Language, and Life: Mathematical Approaches*, Springer, Berlin, (1985).
15. H. Maturana and F. Varla, *Autopoiesis and Cognition: The Realization of the Living*, Reidel, London, (1980).

16. J. Mingers, *Self-Producing Systems: Implications and Application of Autopoiesis*, Plenum Press, New York, (1995).
17. J. Buchler, editor, *Philosophical Writings of Peirce: Selected and Edited with an Introduction by Justus Buchler*, Dover Publications, New York, (1955).
18. T.L. Short, *Peirce's semiotic theory of the self*, *Semiotica*, **91** (1/2), 109-131 (1992).
19. J. von Uexküll, *Umwelt und Innenwelt der Tiere. 2. verm., und verb. Aufl.*, Springer, Berlin, (1921).
20. J. von Uexküll, The theory of meaning, *Semiotica*, 42(1), 25-87 (1982 [1940]).
21. T. von Uexküll, *Introduction: Meaning and science in Jacob von Uexküll's concept of biology*, *Semiotica*, **42**, 1-24 (1982).
22. T. von Uexküll, *Medicine and semiotics*, *Semiotica*, **61**, 201-217 (1986).
23. G. Bateson, *Form, substance, and difference. Nineteenth Annual Korzybski Memorial Lecture*, (1970). Reprinted in G. Bateson, *Steps to an Ecology of Mind*, Balentine Books, New York, (1972), pp. 448-464.
24. G. Bateson, *Mind and Nature: A Necessary Unity*, Bantam Books, New York, (1980).
25. G. Bateson, *Sacred Unity: Further Steps to an Ecology of Mind*, Harper Collins, New York, (1991).
26. J. Ruesch and G. Bateson, *Communication*, Norton, New York, (1987).
27. E.F. Yates, *Semiotics as a bridge between information (biology) and dynamics (physics)*, *Recherches Semiotiques/Semiotic Inquiry* **5**, 347- 360 (1985).
28. T.A. Sebeok, *Communication in animals and men*, *Language*, **39**, 448-466 (1963).
29. T.A. Sebeok, *The Sign and its Masters*, University of Texas Press, (1979).
30. P. Bouissac, *Ecology of semiotic space: Competition, exploitation, and the evolution of arbitrary signs*, *Am. J. Semiotics*, **10**, 145-166 (1972).
31. F. Varla, *Autopoiesis: A Theory of Living Organization*, North Holland, New York, (1986).
32. R. Posner, K. Robins and T.A. Sebeok, editors, *Semiotics: A Handbook of the Sign-Theoretic Foundations of Nature and Culture*, Walter de Gruyter, Berlin, (1992).
33. R. Paton, *The ecologies of hereditary information*, *Cybernetics and Human Knowing*, **5**(4), 31-44 (1998).
34. T. Stonier, *Information and the Internal Structure of the Universe*, Springer, Berlin, (1990).
35. T. Stonier, *Information and Meaning: An Evolutionary Perspective*, Springer, Berlin, (1997).

36. C. Zahn-Waxler, *Altruism and Aggression: Biological and Social Origins*, Cambridge University Press, (1986).
37. J. Galtung, *A structural theory of aggression*, *Journal of Peace Research*, **1**, 95-119, (1964).
38. G.E. Kang, *Exogamy and peace relations of social units: A cross-cultural test*, *Ethology*, **18**, 85-99, (1979).
39. A. Montagu, *Man and Aggression*, Oxford University Press, New York, (1968).
40. W.A. Nesbitt, *Human Nature and War*, State Education Department of New York, Albany, (1973).
41. W. Suttles, *Subhuman and human fighting*, *Anthropologica*, **3**, 148-163, (1961).
42. V. Vale and Andrea Juno, editors, *Modern Primitives: An Investigation of Contemporary Adornment and Ritual*, San Francisco Re/Search, (1990).
43. R.A. Hinde, editor, *The Institution of War*, Cambridge University Press, (1991).
44. R.A. Hinde, *Individuals, Relationships and Culture: Links Between Ethology and the Social Sciences*, Cambridge University Press, (1987).
45. R.A. Hinde, *Ethology: Its Nature and Relationship With Other Sciences*
46. R.A. Hinde, *Animal Behaviour: A Synthesis of Ethology and Comparative Psychology*
47. R.A. Hinde, *Non-Verbal Communication*, Cambridge University Press, (1972).
48. R.A. Hinde, *Why Gods Persist: A Scientific Approach to Religion*, Routledge, London, (1999).
49. P.P.G. Bateson and R.A. Hinde, editors, *Growing Points in Ethology: Based on a Conference Sponsored by St. John's College and King's College, Cambridge*, Cambridge University Press, (1976).
50. R.A. Hinde, A.-N. Perret-Clermont and J. Stevenson-Hinde, editors, *Social Relationships and Cognitive Development*, Clarendon, Oxford, (1985).
51. R.A. Hinde and J. Stevenson-Hinde, editors, *Relationships Within Families: Mutual Influences*, Clarendon Press, Oxford, (1988).
52. P. Bateson, editor, *The Development and Integration of Behaviour: Essays in Honour of Robert Hinde*, Cambridge University Press, (1991).
53. P.J. Bowler, *Evolution: The History of an Idea*, University of California Press, (1989).
54. D.J. Futuyma, *Evolutionary Biology*, Sinauer Associates, Sunderland Mass., (1986).

55. B. Glass, O. Temkin, and W.L. Strauss, eds., *Forerunners of Darwin: 1745-1859*, Johns Hopkins Press, Baltimore, (1959).
56. R. Milner, *The Encyclopedia of Evolution*, an Owl Book, Henry Holt and Company, New York, (1990).
57. T.A. Appel, *The Cuvier-Geoffroy Debate: French Biology in the Decades before Darwin*, Oxford University Press, (1987).
58. P.J. Bowler, *Fossils and Progress: Paleontology and the Idea of Progressive Evolution in the Nineteenth Century*, Science History Publications, New York, (1976).
59. P. Corsi, *The Age of Lamarck: Evolutionary Theories in France, 1790-1834*, University of California Press, Berkeley, (1988).
60. M. McNeil, *Under the Banner of Science: Erasmus Darwin and his Age*, Manchester University Press, Manchester, (1987).
61. L.G. Wilson, *Sir Charles Lyell's Scientific Journals on the Species Question*, Yale University Press, New Haven, (1970).
62. A.B. Adams, *Eternal Quest: The Story of the Great Naturalists*, G.P. Putnam's Sons, New York, (1969).
63. A.S. Packard, *Lamarck, the Founder of Evolution: His Life and Work*, Longmans, Green, and Co., New York, (1901).
64. C. Darwin, *An historical sketch of the progress of opinion on the Origin of Species, previously to the publication of this work*, Appended to third and later editions of *On the Origin of Species*, (1861).
65. L. Eiseley, *Darwin's Century: Evolution and the Men who Discovered It*, Doubleday, New York, (1958).
66. H.F. Osborne, *From the Greeks to Darwin: The Development of the Evolution Idea Through Twenty-Four Centuries*, Charles Scribner and Sons, New York, (1929).
67. Sir Julian Huxley and H.B.D. Kettlewell, *Charles Darwin and his World*, Thames and Hudson, London (1965).
68. Allan Moorehead, *Darwin and the Beagle*, Penguin Books Ltd. (1971).
69. Francis Darwin (editor), *The Autobiography of Charles Darwin and Selected Letters*, Dover, New York (1958).
70. Charles Darwin, *The Voyage of the Beagle*, J.M. Dent and Sons Ltd., London (1975).
71. Charles Darwin, *The Origin of Species*, Collier MacMillan, London (1974).
72. Charles Darwin, *The Expression of Emotions in Man and Animals*, The University of Chicago Press (1965).
73. Ruth Moore, *Evolution*, Time-Life Books (1962).
74. L. Barber, *The Heyday of Natural History: 1820-1870*, Doubleday and Co., Garden City, New York, (1980).
75. A. Desmond, *Huxley*, Addison Wesley, Reading, Mass., (1994).

76. R. Owen, (P.R. Sloan editor), *The Hunterian Lectures in Comparative Anatomy, May-June, 1837*, University of Chicago Press, (1992).
77. C. Nichols, *Darwinism and the social sciences*, Phil. Soc. Scient. **4**, 255-277 (1974).
78. M. Ruse, *The Darwinian Revolution*, University of Chicago Press, (1979).
79. A. Desmond and J. Moore, *Darwin*, Penguin Books, (1992).
80. R. Dawkins, *The Extended Phenotype*, Oxford University Press, (1982).
81. R. Dawkins, *The Blind Watchmaker*, W.W. Norton, (1987).
82. R. Dawkins, *River out of Eden: A Darwinian View of Life*, Harper Collins, (1995).
83. R. Dawkins, *Climbing Mount Improbable*, W.W. Norton, (1996).
84. S.J. Gould, *Ever Since Darwin*, W.W. Norton, (1977).
85. R.G.B. Reid, *Evolutionary Theory: The Unfinished Synthesis*, Croom Helm, (1985).
86. M. Ho and P.T. Saunders, editors, *Beyond Neo-Darwinism: An Introduction to a New Evolutionary Paradigm*, Academic Press, London, (1984).
87. J. Maynard Smith, *Did Darwin Get it Right? Essays on Games, Sex and Evolution*, Chapman and Hall, (1989).
88. E. Sober, *The Nature of Selection: Evolutionary Theory in Philosophical Focus*, University of Chicago Press, (1984).
89. B.K. Hall, *Evolutionary Developmental Biology*, Chapman and Hall, London, (1992).
90. J. Thompson, *Interaction and Coevolution*, Wiley and Sons, (1982).
91. R.A. Fisher, *The Genetical Theory of Natural Selection*, Clarendon, Oxford, (1930).
92. J.B.S. Haldane, *Population genetics*, New Biology **18**, 34-51, (1955).
93. N. Tinbergen, *The Study of Instinct*, Oxford University Press, (1951).
94. N. Tinbergen, *The Herring Gull's World*, Collins, London, (1953).
95. N. Tinbergen, *Social Behavior in Animals*, Methuen, London, (1953).
96. N. Tinbergen, *Curious Naturalists*, Country Life, London, (1958).
97. N. Tinbergen, *The Animal in its World: Explorations of an Ethologist*, Allan and Unwin, London, (1973).
98. K. Lorenz, *On the evolution of behavior*, Scientific American, December, (1958).
99. K. Lorenz, *Evolution and Modification of Behavior* Harvard University Press, Cambridge, MA, (1961).
100. K. Lorenz, *Studies in Animal and Human Behavior. I and II.*, Harvard University Press, (1970) and (1971).
101. P.H. Klopfer and J.P. Hailman, *An Introduction to Animal Behavior: Ethology's First Century*, Prentice-Hall, New Jersey, (1969).

102. J. Jaynes, *The historical origins of "Ethology" and "Comparative Psychology"*, *Anim. Behav.* **17**, 601-606 (1969).
103. W.H. Thorpe, *The Origin and Rise of Ethology: The Science of the Natural Behavior of Animals*, Heinemann, London, (1979).
104. R.A. Hinde, *Animal Behavior: A Synthesis of Ethological and Comparative Psychology*, McGraw-Hill, New York, (1970).
105. J.H. Crook, editor, *Social Behavior in Birds and Mammals*, Academic Press, London, (1970).
106. P. Ekman, editor, *Darwin and Facial Expression*, Academic Press, New York, (1973).
107. P. Ekman, W.V. Friesen and P. Ekworth, *Emotions in the Human Face*, Pergamon, New York, (1972).
108. N. Blurton Jones, editor, *Ethological Studies of Child Behavior*, Cambridge University Press, (1975).
109. M. von Cranach, editor, *Methods of Inference from Animals to Human Behavior*, Chicago/Mouton, Haag, (1976); Aldine, Paris, (1976).
110. K. Lorenz, *On Aggression*, Bantem Books, (1977).
111. I. Eibl-Eibesfeldt, *Ethology, The Biology of Behavior*, Holt, Rinehart and Winston, New York, (1975).
112. I. Eibl-Eibesfeldt and F.K. Salter, editors, *Indoctrinability, Ideology, and Warfare: Evolutionary Perspectives*, Berghahn Books, (1998).
113. I. Eibl-Eibesfeldt, *Human Ethology*, Walter De Gruyter Inc., (1989).
114. I. Eibl-Eibesfeldt, *Love and Hate*, Walter De Gruyter Inc., (1996).
115. J. Bowlby, *By ethology out of psychoanalysis: An experiment in interbreeding*, *Animal Behavior*, **28**, 649-656 (1980).
116. B.B. Beck, *Animal Tool Behavior*, Garland STPM Press, New York, (1980).
117. R. Axelrod, *The Evolution of Cooperation*, Basic Books, New York, (1984).
118. J.D. Carthy and F.L. Ebling, *The Natural History of Aggression*, Academic Press, New York, (1964)
119. D.L. Cheney and R.M. Seyfarth, *How Monkeys See the World: Inside the Mind of Another Species*, University of Chicago Press, (1990).
120. F. De Waal, *Chimpanzee Politics*, Cape, London, (1982).
121. M. Edmunds, *Defense in Animals*, Longman, London, (1974).
122. R.D. Estes, *The Behavior Guide to African Mammals*, University of California Press, Los Angeles, (1991).
123. R.F. Ewer, *Ethology of Mammals*, Logos Press, London, (1968).
124. E. Morgan, *The Scars of Evolution*, Oxford University Press, (1990).
125. W.D. Hamilton, *The genetical theory of social behavior. I and II*, *J. Theor. Biol.* **7**, 1-52 (1964).

126. R. Dawkins, *The Selfish Gene*, Oxford University Press, (1989).
127. R.W. Sussman, *The Biological Basis of Human Behavior*, Prentice Hall, Englewood Cliffs, (1997).
128. Irenäus Eibl-Eibesfeldt, *The Biology of Peace and War*, Thames and Hudson, New York (1979).
129. R.A. Hinde, *Biological Bases of Human Social Behavior*, McGraw-Hill, New York (1977).
130. R.A. Hinde, *Towards Understanding Relationships*, Academic Press, London (1979).
131. Albert Szent-Györgyi, *The Crazy Ape*, Philosophical Library, New York (1970).
132. E.O. Wilson, *Sociobiology*, Harvard University Press (1975).
133. C. Zhan-Waxler, *Altruism and Aggression: Biological and Social Origins*, Cambridge University Press (1986).
134. D.R. Griffin, *Animal Mind - Human Mind*, Dahlem Konferenzen 1982, Springer, Berlin, (1982).
135. R. Dart, *The predatory transition from ape to man*, International Anthropological and Linguistic Review, **1**, (1953).
136. S. Savage-Rumbaugh, R. Lewin, et al., *Kanzi: The Ape at the Brink of the Human Mind*, John Wiley and Sons, New York, (1996).
137. R. Dunbar, *Grooming, Gossip, and the Evolution of Language*, Harvard University Press, (1998).
138. M.E. Bitterman, *The evolution of intelligence*, Scientific American, January, (1965).
139. R. Fox, *In the beginning: Aspects of hominid behavioral evolution*, Man, **NS 2**, 415-433 (1967).
140. M.S. Gazzaniga, *The split brain in man*, Scientific American, **217**, 24-29 (1967).
141. D. Kimura, *The asymmetry of the human brain*, Scientific American, **228**, 70-78 (1973).
142. R.G. Klein, *Anatomy, behavior, and modern human origins*, Journal of World Prehistory, **9 (2)**, 167-198 (1995).
143. N.G. Jablonski and L.C. Aiello, editors, *The Origin and Diversification of Language*, Wattis Symposium Series in Anthropology. Memoirs of the California Academy of Sciences, No. 24, The California Academy of Sciences, San Francisco, (1998).
144. S. Pinker, *The Language Instinct: How the Mind Creates Language*, Harper-Collins Publishers, New York, (1995).
145. J.H. Barkow, L. Cosmides and J. Tooby, editors, *The Adapted Mind: Evolutionary Psychology and the Generation of Culture*, Oxford University Press, (1995).

146. D.R. Begun, C.V. Ward and M.D. Rose, *Function, Phylogeny and Fossils: Miocene Hominid Evolution and Adaptations*, Plenum Press, New York, (1997).
147. R.W. Byrne and A.W. Whitten, *Machiavellian Intelligence: Social Expertise and the Evolution of Intellect in Monkeys, Apes and Humans*, Cambridge University Press, (1988),
148. V.P. Clark, P.A. Escholz and A.F. Rosa, editors, *Language: Readings in Language and Culture*, St Martin's Press, New York, (1997).
149. T.W. Deacon, *The Symbolic Species: The Co-evolution of Language and the Brain*, W.W. Norton and Company, New York, (1997).
150. C. Gamble, *Timewalkers: The Prehistory of Global Colonization*, Harvard University Press, (1994).
151. K.R. Gibson and T. Ingold, editors, *Tools, Language and Cognition in Human Evolution*, Cambridge University Press, (1993).
152. P. Mellers, *The Emergence of Modern Humans: An Archaeological Perspective*, Edinburgh University Press, (1990).
153. P. Mellers, *The Neanderthal Legacy: An Archaeological Perspective of Western Europe*, Princeton University Press, (1996).
154. S. Mithen, *The Prehistory of the Mind*, Thames and Hudson, London, (1996).
155. D. Haraway, *Signs of dominance: from a physiology to a cybernetics of primate biology, C.R. Carpenter, 1939-1970*, Studies in History of Biology, **6**, 129-219 (1983).
156. D. Johanson and M. Edey, *Lucy: The Beginnings of Humankind*, Simon and Schuster, New York, (1981).
157. B. Kurtén, *Our Earliest Ancestors*, Columbia University Press, New York, (1992).
158. R.E. Leakey and R. Lewin, *Origins Reconsidered*, Doubleday, New York, (1992).
159. P. Lieberman, *The Biology and Evolution of Language*, Harvard University Press, (1984).
160. J.D. Wall and M. Przeworski, *When did the human population size start increasing?*, Genetics, **155**, 1865-1874 (2000).
161. L. Aiello and C. Dean, *An Introduction to Human Evolutionary Anatomy*, Academic Press, London, (1990).
162. F. Ikawa-Smith, ed., *Early Paleolithic in South and East Asia*, Mouton, The Hague, (1978).
163. R.R. Baker, *Migration: Paths Through Space and Time*, Hodder and Stoughton, London, (1982).
164. P. Bellwood, *Prehistory of the Indo-Malaysian Archipelago*, Academic Press, Sidney, (1985).

165. P.J. Bowler, *Theories of Human Evolution: A Century of Debate, 1884-1944*, Basil Blackwell, Oxford, (1986).
166. G. Isaac and M. McCown, eds., *Human Origins: Louis Leaky and the East African Evidence*, Benjamin, Menlo Park, (1976).
167. F.J. Brown, R. Leaky, and A. Walker, *Early Homo erectus skeleton from west Lake Turkana, Kenya*, *Nature*, **316**, 788-92, (1985).
168. K.W. Butzer, *Archeology as Human Ecology*, Cambridge University Press, (1982).
169. A.T. Chamberlain and B.A. Wood, *Early hominid phylogeny*, *Journal of Human Evolution*, **16**, 119-33, (1987).
170. P. Mellars and C. Stringer, eds., *The Human Revolution: Behavioural and Biological Perspectives in the Origins of Modern Humans*, Edinburgh University Press, (1989).
171. G.C. Conroy, *Primate Evolution*, W.W. Norton, New York, (1990).
172. R.I.M. Dunbar, *Primate Social Systems*, Croom Helm, London, (1988).
173. B. Fagan, *The Great Journey: The Peopling of Ancient America*, Thames and Hudson, London, (1987).
174. R.A. Foley, ed., *Hominid Evolution and Community Ecology*, Academic Press, New York, (1984).
175. S.R. Binford and L.R. Binford, *Stone tools and human behavior*, *Scientific American*, **220**, 70-84, (1969).
176. G. Klein, *The Human Career, Human Biological and Cultural Origins*, University of Chicago Press, (1989).
177. B.F. Skinner and N. Chomsky, *Verbal behavior*, *Language*, **35** 26-58 (1959).
178. D. Bickerton, *The Roots of Language*, Karoma, Ann Arbor, Mich., (1981).
179. E. Lenneberg in *The Structure of Language: Readings in the Philosophy of Language*, J.A. Fodor and J.A. Katz editors, Prentice-Hall, Englewood Cliffs N.J., (1964).
180. S. Pinker, *Talk of genetics and visa versa*, *Nature*, **413**, 465-466, (2001).
181. S. Pinker, *Words and rules in the human brain*, *Nature*, **387**, 547-548, (1997).
182. M. Ruhelen, *The Origin of Language*, Wiley, New York, (1994).
183. C.B. Stringer and R. McKie, *African Exodus: The Origins of Modern Humanity*, Johnathan Cape, London (1996).
184. R.W. Sussman, *The Biological Basis of Human Behavior*, Prentice Hall, Englewood Cliffs, (1997).
185. D.P. Barash *Sociobiology and Behavior*, Elsevier, New York, (1977).
186. J.D. Carthy and F.J. Eblin, eds., *The Natural History of Aggression*, Academic Press, New York, (1964).

187. N.A. Chagnon and W. Irons, eds., *Evolutionary Biology and Human Social Behavior, an Anthropological Perspective*, Duxbury Press, N. Scituate, MA, (1979).
188. E. Danielson, *Vold, en Ond Arv?*, Gyldendal, Copenhagen, (1929).
189. M.R. Davie, *The Evolution of War*, Yale University Press, New Haven, CT, (1929).
190. T. Dobzhanski, *Mankind Evolving*, Yale University Press, New Haven, CT, (1962).
191. I. Eibl-Eibesfeldt, *Der Vorprogrammiert Mensch*, Molden, Vienna, (1973).
192. I. Eibl-Eibesfeldt, *Ethology, the Biology of Behavior*, Holt, Rinehart and Winston, New York, (1975).
193. I. Eibl-Eibesfeldt, *Liebe und Hass*, Molden, Vienna, (1973).
194. R.L. Holloway, *Primate Aggression: Territoriality and Xenophobia*, Academic Press, New York, (1974).
195. P. Kitcher, *Vaulting Ambition: Sociobiology and the Quest for Human Nature*, MIT Press, Cambridge, MA, (1985).
196. S.L.W. Mellen, *The Evolution of Love*, Freeman, Oxford, (1981).
197. A. Roe and G.G. Simpson, *Behavior and Evolution*, Yale University Press, New Haven, CT, (1958).
198. N.J. Smelser, *The Theory of Collective Behavior*, Free Press, New York, (1963).
199. R. Trivers, *Social Evolution*, Benjamin/Cummings, Menlo Park, CA, (1985).
200. W. Weiser, *Konrad Lorenz und seine Kritiker*, Piper, Munich, (1976).
201. W. Wickler, *Biologie der 10 Gebote*, Piper, Munich, (1971).

Index

- être, 148
öffentliches, 147
über, 150, 151
école, 142
écrire, 147
été, 148
étaient, 148
était, 148
étant, 148
état, 142
étudiant, 142
à, 150, 151
à côté de, 151
à propos de, 149
à travers, 150
ARPANET, 101, 102
ATP, 48
Abbevillian, 74
Abolition of war, 167
Abstraction, 114
Abstraction of patterns, 48
Acceleration of cultural evolution, 155
Accents, 170
Acetylcholine, 47
Action potential, 106
Activation, 108
Activation energy, 45
Active site, 34, 45
Adaptor molecule, 36
Adenine, 31
Adjectives, 146
Adverbs, 148
Age of the earth, 17
Aggression, 59
Agricultural revolution, 155
Alpha-proteobacteria, 80
Amino acid sequences, 34, 104
Amino acids, 34, 40, 45
Anaerobic ecological niches, 80
Ancestor worship, 170
Ancestral adaptations, 22
Aniline dyes, 41
Animal languages, 57, 62
Anions, 48
Anthropoid apes, 73
Antibiotic-resistant pathogens, 44
Antibiotics in agriculture, 44
Antigens, 44
Arab nationalism and Islam, 171
Ardipithecus ramidus, 74
Aristotle, 21
Articles, 151
Artificial intelligence, 104
Artificial neural networks, 105, 110
Augmented weight vector, 109
Aurignacean, 74
Australopithecus, 74
Autoassembly, 104
Autoradiography, 32
Avery, O.T., 31
Axons, 46, 48, 105
Bacterial cell wall, 34
Bacteriophages, 40
Baer, Karl Ernst von, 22
Baran, Paul, 101
Barnacles, 20

- Beadle, George, 35
 Beagle, 16
 Beetle collecting, 14
 Benedin, Edouard van, 27
 Bernal, J.D., 34
 Binomial nomenclature, 8
 Bio-information technology, 104
 Biological neural networks, 105
 Biology, 104
 Biology of War and Peace, 168
 Biosynthesis of hemoglobin, 35
 Biosynthesis of proteins, 35
 Bohr, Niels, 114
 Bombykol, 57, 62
 Bombyx mori, 57, 62
 Bonet, Charles, 17
 Boolean functionality, 110
 Botanic Garden, 12
 Botany, 7, 14
 Brain size, 76
 Brain structure and functions, 105
 Bremer, Sidney, 40
 Broca's area, 74
 Broom, Robert, 74
 Burial customs, 170
 Bushbabies, 59, 67
 Cambridge University, 14, 31, 34
 Carbohydrates, 45
 Caste markings, 170
 Catalysis, 45
 Catastrophist school, 17
 Cave-man's brain, 163
 Cell differentiation, 46
 Cell membrane, 46
 Cell society, 46
 Cell-surface antigens, 44, 78
 Central processing units, 105
 Ceremonies, 170
 Cerf, Vinton, 102
 Chadors, 170
 Channel weights, 108
 Chargaff, Erwin, 31
 Charge distributions, 42
 Chartist movement, 19
 Checks on population growth, 21
 Chemical signals, 57, 62
 Chemical trails, 58, 63
 Chemotherapy, 42
 Chimpanzees, 73
 Choukoutian, 74
 Chromatography, 32
 Chromosomes, 27
 Circumcision, 170
 Clark, W., 101
 Classes, 8
 Classical genetics, 25
 Classification, 8, 110
 Classification of species, 22
 Classifier network, 110
 Climatic stability, 155
 Codons, 40
 Combustion of glucose, 80
 Communication between cells, 46
 Compassion, 167
 Competition, 168
 Complementarity, 36, 41, 45, 105, 114
 Computer scientists, 104
 Conformational change, 46
 Conjugal bridge, 44
 Consciousness, 153
 Convergent evolution, 50
 Crick, Francis, 31, 36, 40
 Crisis, 172
 Crisis of civilization, 167
 Cruelty by children, 170
 Crusades, 171
 Crystallization, 105
 Crystallography, 31, 104
 Cultural barriers to marriage, 167
 Cultural evolution, 73
 Cultural skills, 77
 Cuvier, 8

- Cyclic AMP, 46
Cytosine, 31
DNA, 35, 36
DNA structure, 31
DNA, Y-chromosomal, 78
DNA, mitochondrial, 78
Dale, Henry, 47
Dances and songs, 170
Dart, Raymond, 74
Darwin, Charles, 13, 25, 26, 40, 59, 77, 163, 171
Darwin, Erasmus, 12, 13, 21
Dawkins, Richard, 163
De Vries, Hugo, 26
Decision hyperplane, 108, 110
Dendrites, 46, 105
Depolarization, 48
Descent of Man, 77
Dialects, 170
Diction, 170
Diet, 170
Digital universe, 102
Dirac, P.A.M., 114
Dispersal of modern humans, 81
Diversity, 78
Domestication, 13
Domestication of animals, 155
Dominant genes, 26
Dopamine, 47
Double-stranded DNA, 32
Dubois, Eugene, 73
Dwarf peas, 25
Eastern Eurasia, 81
Edinburgh University, 13
Effector part, 46
Egg cells, 27
Ehrlich, Paul, 41, 104
Eibl-Eibesfeldt, Irenäus, 168, 172
Electric organs, 153
Electron microscopy, 32, 36
Electron spin resonance, 32
Electrophoresis, 32
Electrostatic complementarity, 42
Electrostatic forces, 34, 45
Embryos, 22
Endosymbionts, 80
Environmental threats, 163
Enzymes, 35, 45, 104
Ergot fungus, 47
Estrogen, 46
Ethical principles, 172
Ethics, 167
Ethnicity, 167
Ethnicity and religion, 171
Ethology, 153
European colonial conquests, 171
Evolution of consciousness, 153
Evolution of human language, 73
Evolution of language, 77
Evolutionary genetics, 104
Excess charge, 42, 45, 104
Exodus from Africa, 79, 84
Exploding populations, 163
Expression of emotions, 59
FOXP2 gene, 77
Family structure, 77
Family tree, 22
Female lines, 80
Fertility of mixed marriages, 167
Filed teeth, 170
Finches, 17
Fire, use of, 76
FitzRoy, Robert, 15
Flemming, Walther, 27
Flow of information, 45
Folding of proteins, 45
Fossil animals, 18, 19
Fossils, 17, 74
Franklin, Rosalind, 31
Frequency of mutations, 80
Frisch. Karl von, 58, 63
Galactic network, 101

- Galagos, 59, 67
Galapagos Archipelago, 17, 19
Gama-amino buteric acid, 47
Gametes, 44
Gandhi, Mahatma, 114
Ganglions, 48
Garrod's hypothesis, 35
Garrod, Archibald, 35
Gate of Grief, 84
Genealogical classification, 22
Genera, 8
Generalization, 105
Genesis, Book of, 8
Genetic algorithms, 104
Genetic code, 40
Genetic drift, 81
Genetic information, 44
Genetic lottery, 25, 78
Genetic material, 32
Genetics, 25
Genocide, 172
Genocide against Jews, 172
Geology, 14, 16
German nationalism, 171
Giant squid axon, 48
Gibbons, Ann, 84
Gibbs free energy, 48, 105
Gills, 22
Glutamate, 47
Gorillas, 73
Gracile skeletons, 76
Grandmother's face cells, 110
Grant, R.E., 14
Greed and folly, 163
Greenberg, Joseph, 86
Guanine, 31
Hamilton, W.D., 163
Hardware, 104
Hemoglobin, 34, 35
Henslow, John Stephens, 14
Hereditary disease, 35
Hierarchical relationship, 36
Histology, 105
History, 170
Hodgkin, Alan, 48
Hodgkin, Dorothy Crowfoot, 34
Homeostasis, 46
Hominids, 74
Homo erectus, 74, 76
Homo habilis, 74
Homo sapiens, 74
Homologies, 23
Hooker, Sir Joseph, 19, 20
Horizontal information transfer, 44
Hormones, 46
Hospitality, 170
Hostility, 59
Hubel, David H., 50
Human emotions, a paradox, 163
Human language, 73
Human nature, 171
Human prehistory, 73, 78, 80
Humboldt, Alexander von, 15, 16
Hunter-gatherers, 77
Hutton, James, 16
Huxley, Andrew, 48
Huxley, Thomas Henry, 48, 73
Hybrids, 25
Hydrogen bonds, 32
Hydrophilic groups, 34, 45
Hydrophobic groups, 34, 45
Image-forming eye, 50
Immune systems, 44, 78
Immunity, mechanism of, 42
Information flow, 45
Information technology, 104
Information transfer between cells, 44
Inhibitory neurotransmitters, 47
Input channels, 108
Instincts, 22, 77
Insulin, 34, 46
Interjections, 151

- Internet, 101, 102
Internet traffic, 102
Internet users, total, 102
Internuncial part, 46, 48
Intertribal massacres, 172
Invertebrate zoology, 14
Ion pump, 48
Ituri Province of Congo, 172
JANET, 102
Jarmo, 155
Jericho, 155
Kahn, Robert F., 102
Kendrew, J.C., 34
Kew Botanical Gardens, 19
Khorana, H. Gobind, 40
Kings College, London, 31
Kleinrock, 101
Kleinrock, Leonard, 101
Koch, Robert, 41
Kornberg, Arthur, 40
Kosovo, 172
Kuffler, Steven W., 48, 110
Kurdish civilians gassed, 172
L3 lineage, 80
Laetoli footprints, 74
Lake Rudolph, 74
Lamarck, Chevalier de, 14, 21
Land bridge, 18
Language and ethnic identity, 170
Lapland, 7
Leaky, Louis and Mary, 74
Learning, 105, 109
Lebanese civil war, 172
Lederberg, J., 44
Licklider, J.C.R., 101
Light-receptor cells, 48
Linguistic ability, 84
Linguistically-based prehistory, 86
Linnaeus, Carolus, 7, 12, 73
Linnean Society, 20
Literature, 170
Local communities, 170
Lock and key mechanism, 42, 104
Loewi, Otto, 47
Lorenz, Konrad, 59, 153, 163, 168
Lyell's hypothesis, 17
Lyell, Sir Charles, 16, 19, 20
Lysozyme, 34
M and N lineages, 81
M168 mutation, 79
M242 mutation, 79
Magdalenian, 74, 155
Male lines, 80
Malthus, T. Robert, 19
Mammalian eye, 48
Mammalian retina, 110
Marriage across ethnic boundaries, 172
Massacres, 172
Maternal behavior, 57, 62
Matthaei, Heinrich, 40
McCulloch, Warren, 105
Mechanism of immunity, 42
Mechanism of the brain, 104
Mellars, Sir Paul, 81, 84
Membrane permeability, 48
Membrane-bound proteins, 46
Mendel, Gregor, 25
Mendelian laws, 26
Messenger RNA, 45
Messenger RNA (mRNA), 36
Metabolism, 36
Metal-containing proteins, 35
Miescher, Friedrich, 31
Miniaturization, 104
Misuse of science, 167
Mitochondrial DNA, 78, 80
Mitochondrial Eve, 81
Modification of species, 17
Molecular biology, 25, 32
Molecular charge distributions, 45
Molecular complementarity, 41, 104
Moore's law, 104

- Moustrian, 74
Multicellular organisms, 46
Mutant strains, 35
Mutations, 26
Myoglobin, 34
NSFNET, 102
Nationalism and religion, 171
Natural selection, 19, 21, 22
Nazi Party, 171
Neanderthal man, 73, 76
Neanderthals, 84
Negative feedback, 153
Neptunists, 17
Nerve endings, 42
Nervous systems, 46
Nest scent, 58, 63
Neural networks, 105
Neurons, 46, 105
Neurophysiology, 104, 105, 110
Neurospora, 35
Neurotransmitter molecules, 47, 106
Nirenberg, Marshall, 40
Nodes, 101
Noradrenalin, 47
Norepinephrine, 47
Nouns, 141
Nuclear magnetic resonance, 32
Nucleotide sequences, 104
Ocha, Sevaro, 40
Octopus brain, 50
Octopus eye, 50
Off-center arrays, 50
Oldowan, 74
Olduvai gorge, 74
Omnivorous diet, 77
On-center arrays, 50
Orders, 8
Origin of Species, 19, 20
Otters, 21
Output channel, 108
Oversimplification, 114
Oxidative phosphorylation, 80
Oxygen crisis, 80
Package switching systems, 101
Palade, George Emil, 36
Parasites, 44, 78
Pathogenic bacteria, 42
Pattern abstraction, 50, 110
Pattern recognition, 109
Pattern space, 108
Pattern vector, 109
Pattern-recognition, 105
Pauling, Linus, 31, 35
Peacock, George, 15
Peking man, 76
Perutz, Max, 34
Phagocytes, 42
Phenylalanine, 40
Pheromones, 57, 62
Phillips, D.C., 34
Photosynthesis, 80
Phyla, 8
Pithecanthropus erectus, 73
Pitts, Walter, 105
Plant species, 8
Plasmids, 44
Plutonists, 17
Pneumococci, 31
Poetry, 170
Poison gas, 172
Polarized light, 153
Pollination, 25
Polymerase, 40
Polynucleotides, 45
Polypeptides, 34
Post-synaptic cleft, 47, 106
Primate hand, 77
Principles of Geology, 16
Progesterone, 46
Programs of the brain, 57, 62
Prolactin, 46
Pronouns, 143

- Protein chain, 36
Protein structure, 34, 104
Proteins, 45, 104
Prussian army officers, 168
Pseudospeciation, 167
Ptepositions, 150
Queen substance, 57, 63
R-factors, 44
R-type pneumococci, 31
RNA, 35, 36, 104
RNA and ribosomes, 35
RNA polymerase, 40
Racial cleansing, 172
Radio-carbon dating, 155
Radioactive tracer techniques, 32
Radioactive tracers, 36
Rampino, Michael R., 84
Random variation, 22
Receptors, 46, 57, 62, 106
Recessive genes, 25
Red Sea, 84
Religion and culture, 171
Religion and ethnicity, 171
Reproductive information, 59, 67
Resting potential, 48
Ribonucleic acid, 35
Ribosomes, 36
Rice cultivation, 155
Ritual scarification, 168
Rituals, 170
Rockefeller Institute, 31, 36
Royal Institution, London, 34
S-type pneumococci, 31
Saddam Hussien's atrocities, 172
Saint-Hillaire, Etienne Geoffrey de, 21
Salamander, 22
Salamandra atra, 22
Sanger, Frederick, 34
Sartre, Jean-Paul, 103
Satellite communication, 101
Scalar product, 109
Schrödinger, 114
Seals, 21
Sedgwick, Adam, 15
Selection, 19
Self, Steven, 84
Self-assembly, 104
Self-pollination, 25
Sense of smell, 57, 62
Sequencing methods, 34
Serial homologies, 23
Serotonin, 47
Sexual reproduction, 44, 78
Shanidar, 155
Siberia-Alaska land bridge, 84
Sickle-cell anemia, 35
Side chains, 42
Side groups, 34
Signal molecules, 57, 62
Simulated evolution, 104
Sinanthropus pekinensis, 74
Single-stranded DNA, 32
Skhul and Qafzeh, 84
Sleeping sickness, 42
Slime molds, 46
Social information, 59, 67
Social interactions, 102
Softening ethnic boundaries, 172
Software, 104
Solutrian, 74, 155
Soma, 105
South American species, 17
Spatial complementarity, 42
Species, 8, 167
Species, modification of, 17
Specificity, 41
Sperm cells, 27
Staining cells, 41
Stanford University, 35
Steric complementarity, 42
Structure of proteins, 104
Struggle for existence, 21

- Sub-Saharan Africa, 79
- Subcellular particles, 36
- Substrate molecules, 45
- Sugar-phosphate backbone, 32
- Supramolecular structures, 104
- Surface antigens, 46
- Synapses, 47, 106
- Synthesis of proteins, 36
- Synthetic RNA, 40
- Syphilis, 42
- Systema Naturae, 8, 73
- TLU, 105, 108, 109
- Tattoos, 170
- Tatum, Edward, 35
- Templates, 32
- Tertiary conformation, 45
- Thermonuclear war, 163
- Three-letter code, 40
- Threshold, 108
- Threshold Logical Unity (TLU), 105
- Thymine, 31
- Tierra del Fuego, 15
- Toba Catastrophe Theory, 84
- Tobacco mosaic virus, 104
- Tool making, 155
- Training algorithms, 110
- Transfer RNA, 36
- Transmitter molecules, 46
- Transmutation of species, 19
- Tribal markings, 168
- True-breeding plants, 25
- Two-layer network, 110
- Uexküll, Jakob von, 153
- Ultracentrifugation, 32
- Ultraviolet light, 153
- Ultraviolet spectroscopy, 32
- Umwelt, 153
- Underhill, Peter, 81
- Uniformitarianism, 16
- Unity of life, 13
- Universal human brotherhood, 167, 172
- Universality of religion, 171
- Upper Paleolithic technology, 84
- Upright locomotion, 74
- Urine markings, 59, 67
- Value systems, 170
- Van der Waals forces, 45
- Vanishing resources, 163
- Variability, 44
- Variation under domestication, 13, 21
- Veils, 170
- Verbs, 147
- Vertical information transfer, 44
- Vestigial organs, 21
- Virchow, Rudolf, 73
- Visual cortex, 48, 110
- Visual displays, 59
- Vitamin B12, 34
- Volcanic islands, 17, 21
- Vries, Hugo de, 26
- Wade, Nicholas, 86
- Waggle dance, 58, 63
- Wallace, Alfred Russell, 20, 21
- Wars of religion, 171
- Watson, James, 31
- Watson-Crick model, 32
- Wave of depolarization, 48, 106
- Weapon-making, 155
- Wedgwood, Josiah, 16
- Weight vector, 109
- Wessel, Torsten N., 50
- Western Eurasia, 79, 81
- Whales, 21
- Wilkins, Maurice, 31
- Wilson, E.O., 163
- World Wide Web, 101
- Wurm glacial period, 155
- X-ray diffraction, 31, 32
- Y-Chromosomal Adam, 81
- Y-chromosomal DNA, 78
- Young, J.Z., 50

- Zagros mountains, 155
Zettabytes, 102
Zionism, 171
Zoology, 14
Zoonomia, 13, 14
- a, 148, 151
aber, 150
able, 146
about, 148–150
above, 150
across, 150
after, 150
again, 150
agricultural crop, 142
aider, 147
Aie, 151
aimer, 147
algae, 142
Algen, 142
algues, 142
all, 144
alle, 144
alles, 144
along, 148
alors, 149, 150
also, 149
alt, 146
always, 149
am, 148, 151
am meisten, 149
américain, 147
American, 147
amerikanisch, 147
among, 150
an, 142, 148, 151
and, 150, 151
andere, 146
anders, 146
anfangen, 148
another, 144
anrufen, 147
any, 144
anybody, 144
anyone, 144
anything, 144
appeler, 147
après, 150
arbeiten, 147
arbre, 141
arbuste, 142
are, 148
area, 142
argent, 142
around, 150
arrière, 148
as, 149
ask, 147
at, 150
au dessous de, 150
au dessus, 150
au lieu, 151
auch, 149
aucun, 144
auf, 151
aujourd'hui, 150
aurait, 148
aus, 148, 151
ausser, 151
aussi, 149
autour, 150
autre, 146
Autsch, 151
avant, 150
avec, 151
avoir, 148
avoir besoin, 147

back, 148
bad, 146
bas, 146
Baum, 141

- be, 148
 beaucoup, 144
 become, 148
 bedeuten, 147
 Beeindruckend, 151
 been, 148
 before, 150
 behalten, 147
 behind, 150
 beide, 144
 beim, 150
 being, 148
 believe, 147
 below, 150
 benötigen, 147
 beneath, 150
 benutzen, 147
 Bereich, 142
 bereitstellen, 147
 beside, 151
 bessere, 146
 best, 146
 beste, 146
 better, 146
 between, 151
 bewegen, 148
 bien, 149
 big, 146
 bin, 148
 black, 146
 blanc, 146
 Blume, 141
 bon, 146
 both, 144
 both... and, 150
 bouger, 148
 buisson, 142
 Bundesland, 142
 Busch, 142
 bush, 142
 but, 150
 by, 151
 call, 147
 can, 148
 capable, 146
 cas, 142
 case, 142
 ce, 145
 celles-ci, 145
 certains, 145
 cette, 145
 ceux, 145
 chambre, 142
 chaque, 144
 chose, 142
 comme, 149, 151
 commencer, 148
 comment, 149
 compagnie, 142
 company, 142
 connaître, 147
 could, 148
 country, 142
 croire, 147
 damit, 149, 150
 dann, 149
 dans, 149, 151
 darüber, 149
 das, 151
 dass, 145
 day, 142
 de, 151
 deine, 143
 demander, 147
 denken, 147
 depuis, 151
 deren, 145
 derrière, 150
 devenir, 148
 devrait, 148
 dich selber, 144

- Dies, 145
diese, 145
différent, 146
different, 146
Ding, 142
dire, 147
doit, 148
donner, 147
dont, 145
dorthin, 149
down, 148, 151
drehen, 148
dur, 146
durch, 151
during, 151
- each, 144
each other, 144
early, 146
eau, 142
echt, 146
ein, 151
ein anderer, 144
einander, 144
eine, 144
einfach, 149
einmal, 150
einzige, 146
either, 144
either... or, 150
elle, 143
en dehors, 148
en dessous de, 151
en haut, 148
encore, 150
endroit, 142
ensuite, 149
entre, 151
entweder, 144
entweder... oder, 150
er, 143
- es, 143
est, 148
et, 150, 151
etwas, 144, 145
euch, 144
even, 149
everybody, 144
everyone, 144
everything, 144
except, 151
- fähige, 146
fühlen, 147
für, 150
facon, 142
faire, 147
Fall, 142
Familie, 142
famille, 142
family, 142
father, 142
feel, 147
femme, 142
few, 144
find, 147
finden, 147
fleur, 141
flower, 141
for, 150
fournir, 147
frühe, 146
fréquemment, 149
Frage, 142
Fragen, 147
Frau, 142
frequently, 149
from, 151
- garder, 147
geben, 147
gegenseitig, 144
Geld, 142

- gens, 142
 gewesen sein, 148
 give, 147
 glauben, 147
 good, 146
 gouvernement, 142
 government, 142
 grand, 146
 Gras, 142
 grass, 142
 great, 146
 gros, 146
 gross, 146
 grosse, 146
 group, 142
 groupe, 142
 Gruppe, 142
 gut, 146, 149
- häufig, 149
 haben, 148
 Hallo, 151
 halten, 147
 Hand, 142
 hand, 142
 happen, 148
 hard, 146
 harte, 146
 has, 148
 hat, 148
 haut, 146
 have, 148
 he, 143
 heimat, 142
 helfen, 147
 help, 147
 her, 143
 herbe, 142
 here, 149
 hers, 143
 herself, 144
- herum, 148
 heute, 150
 Hey, 151
 hier hin, 149
 high, 146
 him, 143
 himself, 144
 hinüber, 148
 hinauf, 148
 hinein, 149
 hinter, 150
 his, 143
 hoch, 146
 hold, 147
 home, 142
 homme, 142
 Hoppla, 151
 hors, 151
 Hou la la, 151
 how, 149
 humain, 147
 human, 147
- I, 143
 ich, 143
 ici, 149
 ihm, 143
 ihr, 143
 Ihre, 143
 ihre, 143
 ihres, 143
 il, 143
 ils, 143
 immer, 149
 immer noch, 149
 important, 146
 in, 149, 151
 instead, 151
 into, 151
 irgendein, 144
 irgenjemand, 144

- is, 148
- ist, 148
- it, 143
- its, 143
- itself, 144

- Jahr, 142
- jamais, 149
- je, 143
- jede einsele, 144
- jeder, 144
- jemand, 144, 145
- jene, 145
- jetzt, 149
- jeune, 146
- jouer, 148
- journée, 142
- jung, 146
- just, 149
- juste, 149

- könnte, 148
- kann, 148
- keep, 147
- keiner, 144
- klein, 146
- know, 147

- l'un et l'autre, 144
- là-bas, 149
- la, 151
- la semaine, 142
- la sienne, 143
- la vie, 142
- laisser, 147
- Land, 142
- Landwirtschaft, 142
- lange, 146
- langsam, 149
- large, 146
- Lassen, 147
- late, 146

- later, 150
- le long de, 148
- le sien, 143
- le tiens, 143
- leave, 148
- Leben, 142, 148
- lentement, 149
- lequel, 145
- les notres, 143
- les plus, 149
- let, 147
- leur, 143
- life, 142
- like, 147, 151
- little, 146
- live, 148
- local, 147
- lokal, 147
- long, 146
- look, 147
- low, 146
- lui, 143
- lui-même, 144

- même, 144
- Männer, 142
- mögen, 147
- mère, 142
- machen, 147
- main, 142
- maintenant, 149
- mais, 150
- maison, 142
- majeur, 146
- major, 146
- make, 147
- man, 142
- many, 144
- mauvais, 146
- may, 148
- me, 143

- mean, 147
 mehr, 149
 mehrere, 145
 meilleur, 146
 mein, 143
 meine, 143
 Menschen, 142
 menschliche, 147
 mettre, 147
 mich, 143
 mich selber, 144
 mien, 143
 might, 148
 mine, 143
 mit, 151
 moi, 143
 moi même, 144
 mon, 143
 monde, 142
 money, 142
 montrer, 147
 more, 149
 most, 149
 mother, 142
 move, 148
 muss, 148
 must, 148
 Mutter, 142
 my, 143
 myself, 144

 n'importe qui, 144
 n'importe quoi, 144
 nach, 150
 Nacht, 142
 national, 147
 neben, 151
 need, 147
 nehmen, 147
 neither... nor, 144, 150
 neu, 146

 never, 149
 new, 146
 ni, 150
 ni... ni, 144, 150
 nicht nur... sondern auch, 150
 nichts, 144
 niedrig, 146
 niemals, 149
 Niemand, 144
 niemand, 144
 night, 142
 no one, 144
 nobody, 144
 noch, 150
 nochmals, 150
 noir, 146
 nombre, 142
 nombreuses, 145
 non plus, 144
 none, 144
 nor, 150
 not only,,, but also, 150
 nothing, 144
 nous, 143
 nous-mêmes, 144
 nouveau, 146
 now, 149
 nuit, 142
 number, 142
 Nummer, 142
 nur, 149

 où, 149
 ob... oder, 150
 oder, 150
 of, 151
 off, 151
 oft, 150
 often, 150
 Oh, 151
 ohne, 151

- old, 146
on, 149, 151
once, 150
one, 144
one another, 144
only, 146, 149
Oops, 151
or, 150
Ort, 142
other, 146
ou, 150
Ouch, 151
ought (to), 148
ours, 143
ourselves, 144
out, 148
over, 148, 151
- père, 142
par, 151
parmi, 150
part, 142
partie, 142
partir, 148
pas seulement... mais aussi, 150
passieren, 148
pays, 142
pendant, 151
penser, 147
people, 142
personne, 144
petit, 146
peu, 144
peux, 148
place, 142
plancton, 142
Plankton, 142
plankton, 142
play, 148
plus, 149
plus de, 151
plus tard, 150
point, 142
political, 147
politique, 147
politisch, 147
pour, 150
pourquoi, 149
pourrait, 148
pouvez, 148
précoce, 146
prendre, 147
problème, 142
Problem, 142
problem, 142
provide, 147
public, 147
Punkt, 142
put, 147
- quand, 149
quelqu'un, 145
quelque chose, 145
question, 142
qui, 145
quickly, 149
quiconque, 145
- région, 142
rapidement, 149
rarement, 149
real, 146
really, 149
recht, 146
red, 146
regarder, 147
Regierung, 142
ressentir, 147
rien, 144
right, 146
room, 142
rot, 146
rouge, 146

- runter, 151
- sûr, 146
- s'asseoir, 148
- sa, 143
- sagen, 147
- sans, 151
- sauf, 151
- say, 147
- Schüler, 142
- scheinen, 147
- schlecht, 146
- schnell, 149
- school, 142
- schreiben, 147
- Schule, 142
- schwarz, 146
- se, 144
- se passer, 148
- seem, 147
- sehen, 147
- sehr, 149
- sein, 148
- seine, 143
- seit, 151
- selbst, 144
- seldom, 149
- selon, 145
- selten, 149
- sembler, 147
- sera, 148
- ses, 143
- seulement, 146, 149
- several, 145
- shall, 148
- she, 143
- should, 148
- show, 147
- shrub, 142
- si... ou, 150
- sich, 144
- sichere, 146
- Sie, 143
- sie, 143
- Sie selber, 144
- since, 151
- sind, 148
- sit, 148
- sitzen, 148
- slowly, 149
- small, 146
- so, 149, 150
- social, 147
- sogar, 149
- soit... ou, 150
- sollte, 148
- some, 145
- somebody, 145
- someone, 145
- something, 145
- sont, 148
- sous, 150
- souvent, 150
- sowohl... und, 150
- sozial, 147
- späte, 146
- später, 150
- speilen, 148
- start, 148
- state, 142
- stattdessen, 151
- stellen, 147
- still, 149
- Strauch, 142
- student, 142
- suis, 148
- sur, 148–151
- sure, 146
- surgir, 142
- système, 142
- System, 142
- system, 142

- Tag, 142
take, 147
tardif, 146
Teil, 142
tell, 147
temps, 142
tenir, 147
that, 145
the, 151
theirs, 143
them, 143
themselves, 144
then, 149
there, 149
these, 145
they, 143
Thiers, 143
thing, 142
think, 147
this, 145
those, 145
through, 151
time, 142
to, 151
today, 150
toi, 143
toi même, 144
too, 149
toujours, 149
tourner, 148
tous les deux, 144
tout, 144
tout le monde, 144
toutes les personnes, 144
toward, 151
très, 149
travailler, 147
tree, 141
trouver, 147
turn, 148
um, 150
un, 144, 151
un autre, 144
und, 150, 151
under, 151
une, 151
une fois, 150
uns, 143
uns selbst, 144
unsere, 143
unten, 148, 150
unter, 150, 151
Unternehmen, 142
up, 148
us, 143
use, 147
utiliser, 147
Vater, 142
veile, 144
verlassen, 148
vers, 151
vers le bas, 151
very, 149
vieux, 146
vivre, 148
von, 151
vor, 150
votre, 143
vouloir, 147
vouloir dire, 147
vous, 143
vous-mêmes, 144
vrai, 146
vraiment, 149
während, 151
würde, 148
wann, 149
want, 147
war, 148
warum, 149

- was, 148
was auch immer, 145
Wasser, 142
water, 142
way, 142
we, 143
weder... noch, 144, 150
week, 142
Weg, 142
weiss, 146
weiter, 149
welche, 145
well, 149
Welt, 142
wem, 145
wenig, 146
wenige, 144
Wer, 145
wer auch immer, 145
werden, 148
were, 148
when, 149
where, 149
whether... or, 150
which, 145
whichever, 145
white, 146
who, 145
whoever, 145
whom, 145
whomever, 145
whose, 145
why, 149
wichtig, 146
wie, 149, 151
will, 148
wir, 143
wird, 148
wirklich, 149
wissen, 147
with, 151
without, 151
wo, 149
Woche, 142
wollen, 147
woman, 142
worüber, 150
work, 147
world, 142
would, 148
Wow, 151
write, 147

year, 142
yet, 150
you, 143
young, 146
your, 143
yours, 143
yourself, 144
yourselves, 144

zeigen, 147
Zeit, 142
Zimmer, 142
zu, 151
zu sein, 148
zum, 151
zurück, 148
zwischen, 151