

LINKED DANGERS TO CIVILIZATION

John Scales Avery

April 7, 2020

Contents

1	DANGERS FROM COVID-19	13
1.1	Rapid mass transport and pandemics	13
1.2	Will the explosively growing COVID-19 epidemic become a global pandemic?	13
1.3	The language of molecular complementarity	15
1.4	Paul Ehrlich, the father of chemotherapy	16
1.5	Mechnikov	21
1.6	Burnet, Jerne and the clonal theory of immunity	23
1.7	Köhler, Milstein and monoclonal antibodies	27
1.8	Molecular biology and genetic engineering	27
1.9	A monoclonal antibody against COVID-19	41
1.10	Mass-production of a COVID-19 antibody	44
1.11	Searching for a vaccine against the COVID-19 virus	44
1.12	Balancing dangers in an emergency	46
2	CATASTROPHIC CLIMATE CHANGE	53
2.1	The climate emergency	53
2.2	The UK declares a climate emergency	53
2.3	The 2018 IPCC report	55
2.4	Greta Thunberg	56
2.5	Worldwide school strike, 15 March, 2019	59
2.6	Solar energy	59
2.7	Wind energy	66
2.8	Hydroelectric power	69
2.9	Energy from the ocean	71
2.10	Biomass	74
2.11	Geothermal energy	79
2.12	Hydrogen technologies	82
2.13	Reducing emissions from the cement industry	85
2.14	Reducing emissions from transportation sectors	88
2.15	Renewables are now much cheaper than fossil fuels!	97
2.16	Lester R. Brown	100
2.17	We must create a livable future world	102
2.18	The Evangelicals believe that there is no need to act	116

2.19	Banks give fossil fuel giants \$1.9 trillion since Paris	116
2.20	Fossil fuel industry's disinformation campaign	124
3	THE DANGER OF THERMONUCLEAR WAR	135
3.1	Militarism and money	135
3.2	Ethology	135
3.3	Population genetics	140
3.4	Hope for the future	142
3.5	Religion and ethnic identity	142
3.6	Tribal markings; ethnicity; pseudospeciation	143
3.7	The arms race prior to World War 1	152
3.8	Krupp, Thyssen and Germany's steel industry	154
3.9	Colonialism and the outbreak of the First World War	154
3.10	Prescott Bush and Hitler	155
3.11	Fritz Thyssen supports Hitler's rise to power	157
3.12	Eisenhower's farewell address	163
3.13	The nuclear arms race	165
3.14	Global famine produced by nuclear war	171
3.15	Military-industrial complexes today	173
3.16	A culture of violence	181
3.17	The threats and costs of war	184
3.18	The threat of nuclear war	190
3.19	Flaws in the concept of nuclear deterrence	194
3.20	Dangers of nuclear power generation	198
3.21	Militarism is the US national religion	204
4	THE DANGER OF WIDESPREAD FAMINE	223
4.1	Several billion people might suffer	223
4.2	Child mortality rates	223
4.3	The threat of large-scale famine	224
4.4	Optimum population in the distant future	226
4.5	Population growth and the Green Revolution	227
4.6	Energy-dependence of modern agriculture	230
4.7	Effects of climate change on agriculture	232
4.8	Harmful effects of industrialized farming	237
4.9	The demographic transition	239
5	THE GLOBAL REFUGEE CRISIS	247
5.1	People fleeing from wars and climate change	247
5.2	A UN ruling on climate refugees	247
5.3	Climate change as genocide	248
5.4	The United Nations High Commission on Refugees	249
5.5	Populations displaced by sea level rise	249

5.6	Populations displaced by drought and famine	250
5.7	Populations displaced by rising temperatures	250
5.8	Populations displaced by war	251
5.9	Political reactions to migration	251
5.10	A more humane response to the refugee crisis	252
6	THE LOSS OF DEMOCRATIC INSTITUTIONS	259
6.1	Drifting towards neo-fascism	259
6.2	Racism, colonialism and exceptionalism	259
6.3	Heart of Darkness	259
6.4	The racism of Cecil Rhodes	263
6.5	Nazi atrocities	264
6.6	Donald trump was elected on a platform of racism	270
6.7	Children in cages	276
6.8	Demonizing the Squad	281
6.9	Jair Bolsonaro, the Trump of the Tropics	283
6.10	Revival of Nazi ideology after World War II	286
6.11	Trump copies Hitler's rhetoric	300
7	APACOLYPTIC LOSS OF BIODIVERSITY	313
7.1	A new mass extinction	313
7.2	A warning from the World Bank	316
7.3	Permian-Triassic extinction event	317
7.4	The Holocene (Anthropocene) extinction	318
7.5	Global warming and atmospheric water vapor	320
7.6	The albedo effect	320
7.7	The methane hydrate feedback loop	323
7.8	A feedback loop from warming of soils	323
7.9	Drying of forests and forest fires	324
7.10	Tipping points and feedback loops	326
7.11	Climate change denial	328
7.12	Humanity betrayed by the mass media	328
7.13	From child author to marine biologist	330
7.14	The Sea Around Us	334
7.15	The Silent Spring	336
7.16	Overuse of pesticides and the insect apocalypse	340
8	INTOLERABLE ECONOMIC INEQUALITY	347
8.1	Shocking statistics	347
8.2	Benefits of equality	347
8.3	Extreme inequality today	350
8.4	Oligarchy replaces democracy in many countries	350
8.5	Media in the service of powerholders	353

8.6	Television as a part of our educational system	353
8.7	Neglect of climate change in the mass media	355
8.8	Climate change denial in mass media	356
8.9	Showing unsustainable lifestyles in mass media	359
8.10	Alternative media	359
8.11	Outstanding voices calling for climate action	360

INTRODUCTION¹

Contrasting rates of change

Cultural evolution depends on the non-genetic storage, transmission, diffusion and utilization of information. The development of human speech, the invention of writing, the development of paper and printing, and finally, in modern times, computers and the Internet: all these have been crucial steps in society's explosive accumulation of information and knowledge. Human cultural evolution proceeds at a constantly-accelerating speed, so great in fact that it threatens to shake society to pieces.

The strong contrast between the slow rate of genetic change and the lightning-like, constantly accelerating rate of cultural change means that we face the serious problems of today with an emotional nature that has changed little since our ancestors lived in small tribes, competing for territory on the grasslands of Africa. It is not surprising that human nature still contains an element of tribalism, to which militarists can all too easily appeal.

Within cultural evolution, there are also contrasting rates of change. Science and technology move extremely rapidly, compared with the slow rate of change of our institutions and habits. This is part of the explanation of our inadequate response to the dangers of catastrophic climate change and thermonuclear war.

Thus, while the explosive growth of knowledge has brought many benefits, the problem of achieving a stable, peaceful and sustainable world remains serious, challenging and unsolved.

Some of the main dangers that we face today are listed below. These dangers are linked to each other, and I will try to put forward some thoughts about the various ways in which they are linked.

Dangers from the COVID-19 epidemic

Today, air travel takes people almost instantly between continents. Despite the need to reduce fossil fuel consumption, air travel has continued to grow, and populations are also growing. Therefore the world has become increasingly vulnerable to pandemics, such as the threatened COVID-19 pandemic.

¹I have used some of my previously published book chapters in this book, but much new material has been added,

The danger of catastrophic climate change

Global warming is occurring much faster than the IPCC's scientists expected. The 2020 winter in Europe has been the warmest ever recorded, with February daytime temperatures averaging about 6 degrees C in Copenhagen. On March 3, 2020, the temperature reached 13 degrees C in Moscow, and 14 degrees in Kiev. Normally these two cities would be snowbound at the start of March. Temperatures of 20 degrees C were recorded in Antarctica! The 2018 IPCC Climate Report made it clear that we have only a decade to drastically reduce CO2 emissions. If we fail to do this, irreversible feedback loops will take over and make any human efforts to avoid catastrophe useless. While some governments have responded to this challenge, a number of large greenhouse gas emitters have not. These include the United States, Canada, Brazil, India, China and Saudi Arabia. While India and China have strong renewable energy programs, they are also building many new coal-fired power plants.

Militarism and the danger of a thermonuclear war

Military-industrial complexes throughout the world involve a circular flow of money. The vast profits from arms industries are used to buy the votes of politicians, who then vote for obscenely bloated defence budgets. Military-industrial complexes need enemies. Without them they would wither. Thus, tensions are manufactured by corrupt politicians in the pay of arms industries. As Arundhati Roy famously observed, Once weapons were manufactured to fight wars. Now wars are manufactured to sell weapons. Donald Trump has recently threatened to attack both Iran and North Korea with nuclear weapons. The United States, under Trump, is also threatening both Russia and China. Any such conflict could escalate uncontrollably into an all-destroying global thermonuclear war.

The danger of an extremely widespread famine

There is a danger that population growth, climate change and the end of the fossil fuel era could combine to produce an extremely large-scale global famine by the middle of the present century. Such a famine might involve several billion people, rather than millions.

The global refugee crisis

The number of refugees from both conflicts and climate change is increasing rapidly. Several million refugees have fled from wars in the Middle East. Meanwhile, drought and rising temperatures in Africa have also produced millions of refugees, anxious for a better life in Europe. Similarly, in the western hemisphere, both conflicts and climate change have produced a stream of desperate people, traveling through Mexico to the southern borders of the United States. There they have been treated in an extremely cruel way by the Trump administration. Young children, infants, have been separated from their parents and put into cages.

The loss of democratic institutions and drift towards neo-fascism

Most notably in the United States and Brazil, but also in a number of other countries, such as Hungary, Turkey and India, there has been a loss of popular control over the institutions of government, and a drift towards authoritarian rule, police brutality, and neo-fascism. Remembering the rise of fascism in Europe in the 1930's we can see worryingly similar trends today.

Apocalyptic loss of biodiversity

In geologically-observed extinction events, such as the Permian-Triassic Extinction, more than 90 percent of all terrestrial vertebrates and marine species were lost forever. It may be that our present episode of human-caused climate change will ultimately lead to a similar mass extinction; but we can already see an alarming loss of biodiversity as the result of human activities such as over-use of pesticides and encroachment on habitat. A new mass extinction has already started.

Intolerable economic inequality

Intolerable and unjust economic inequality is increasing rapidly, both within and between nations. Statistics show that half of the world's net wealth belongs to the top 1%. They own as much as the remaining 99% of the world's peoples, the other 7.4 billion of us.

How are these threats linked?

Let me now put forward some suggestions about how these serious dangers might be linked. I think that there are some obvious links between militarism and the climate crisis. The almost unimaginable amount of money spent on military budgets and wars could instead be spent on the urgent task of building renewable energy infrastructure. Part of this vast river of money now wasted, or worse than wasted on militarism, could provide universal primary health care to all the world's peoples. Together with this care, women could be given the materials and information needed for family planning, thus helping to stabilize the global population of humans. Exploding populations are one of the cause of both the climate crisis and wars. Furthermore, wars are enormously environmentally destructive. Besides involving enormous fossil fuel consumption, wars do direct damage to the environment. We all remember the deforestation produced by the use of agent orange in the Vietnam War, and the oil spills that resulted from wars in the Middle East.

Wars and climate change are linked to the global refugee crisis, and the refugee crisis is in turn linked to swings to the right in politics, and the growth of neo-fascism. In Europe, Hungary, which is experiencing a flood of refugees from wars in the Middle East, now has a highly authoritarian government. The growth of neo-fascist far right parties throughout Europe is due to the refugee crisis. In the United States, the far-right, neo-facist, racist, anti-immigrant government of Donald Trump was voted into power by people who feared that their jobs would be taken by migrants. Something similar can be said about Brexit.

Many of the serious threats that the world faces today are linked to excessive economic inequality. For example, both climate change and militarism are linked to the greed of corporations, whose disproportionate power derives from their extreme wealth. The loss of democratic institutions is also linked to excessive economic inequality. As Professor Noam Chomsky has pointed out, the laws of corporations do not allow their CEO's to have either an ecological conscience or a social conscience. Their only duty is to maximize the profits of the stockholders. If they do not do this, then, by law, they must be replaced. We can remember that Mussolini defined fascism as corporatism.

In the United States, the popular Democratic presidential candidate, Bernie Sanders, has strongly criticized excessive economic inequality and corporate power, had he has proposed a wealth tax. It is interesting that

Bernie Sanders says the he is a democratic socialist. When asked to explain exactly what he means by that, he says the he beleives that the United States would benefit from the type of social and economic system that we can observe today in the Scandinavian countries.

In Denmark, for example, high progressive income taxes have very much reduced economic inequality, so that poverty has been virtually eliminated. These high taxes are used to provide free health care and free education, including free university education for those who qualify. These reforms are what Sanders advocates for the United States. In Denmark, and other Scandinavian countries, corporations and the free market still exist, but they are strongly regulated. It is interesting to notice that the Scandinavian countries are leaders in renewable energy programs and in reduction of greenhouse gas emissions.

In conclusion, let me say that many of the serious dangers that we face today can be addressed by reforming our economic systems. Greed-sanctioning and growth-worshipping economics, the economics that has led to intolerable economic inequality, must be replaced by steady-state economics, and with the reforms that we can observe in present-day Scandinavia.

Chapter 1

DANGERS FROM COVID-19

1.1 Rapid mass transport and pandemics

Today, air travel takes people almost instantly between continents. Despite the need to reduce fossil fuel consumption, air travel has continued to grow, and populations are also growing. Therefore the world has become increasingly vulnerable to pandemics, such as the threatened COVID-19 pandemic.

1.2 Will the explosively growing COVID-19 epidemic become a global pandemic?

It is difficult to write about the COVID-19 emergency because the situation changes drastically, not just from day to day, but from hour to hour. I am writing this on the 11th of March, 2020. Here are links to a few articles that describe what is happening:

- **US Is Not Prepared for Coronavirus. We Need a Massive Expansion of Health Care**, by Kevin Zeese and Margaret Flowers, Popular Resistance, March 3, 2020.
- **Patents Are Slowing the Development of a Coronavirus Vaccine**, by Dean Baker, Truthout, March 2, 2020.
- **China's coronavirus crisis wanes while epidemic takes hold in U.S. and spreads to 80 countries**, by Countercurrents Collective, Countercurrents, March 2, 2020.
- **U.S. public health departments scramble against coronavirus, decimated by funding cuts**, by Countercurrents Collective, Countercurrents, March 2, 2020.
- **'Do wear masks but don't think you're safe': Top Soviet virologist & WHO expert explains Covid-2019 & debunks popular myths**, by Countercurrents Collective, Countercurrents, March 2, 2020.
- **Trump White House Bars Press From Filming or Recording Coronavirus Briefing**, by Jake Johnson, Common Dreams, March 4, 2020.

- **Violations at US Hospitals Reveal They're Not Ready for Coronavirus**, By Marshall Allen, Caroline Chen J. David McSwane & Lexi Churchill, ProPublica, March 4, 2020.
- **Coronavirus and the Terrifying Muzzling of Public Health Experts**, By Union of Concerned Scientists, Ecowatch, February 29, 2020.
- **Coronavirus: Countries are not grasping reality of threat, warns WHO chief as 300 million students sent home worldwide**, By Countercurrents Collective, March 6, 2020.
- **As CDC Says 'Do Not Go to Work,' Trump Says Thousands With Coronavirus Could Go to Work and Get Better**, By Common Dreams, Ecowatch, March 5, 2020.
- **Three Intravenous Vitamin C Research Studies Approved for Treating COVID-19**, by Andrew W. Saul, TMS Weekly Digest, 9 March, 2020.
- **Coronavirus Update: WHO Chief Calls for Private Sector to Step Up, and, Should You Take That Flight?**, by UN News, TMS Weekly Digest, 9 March, 2020.
- **COVID-19 Is A Classic Example Of The Dangers Of Putting Profits Over Health**, by Kevin Zeese and Margaret Flowers, Popular Resistance, March 8, 2020.
- **Coronavirus study predicts 15 million dead and a \$2.4 trillion hit to global GDP**, by Reuters, Information Clearing House, March 7, 2020.
- **Plunging Stock Market Ignites Fears of Meltdown as Coronavirus Spreads**, by Jake Johnson, Common Dreams, March 9, 2020.
- **Trump Bears Full Responsibility for Botched Response to Coronavirus in US**, by Dean Baker, Truthout, March 9, 2020.
- **Coronavirus and Ebola Show We Can't Leave Vaccine Development to Big Pharma**, by Juliana Broad, Truthout, March 9, 2020.
- **It's Not Just Pence. Evangelicals Are Leading US Coronavirus Response.**, by Heather Digby Parton, Salon, March 9, 2020.
- **U.S.: Leaders' fatal error in virus response**, by Jamie Seidel, Information Clearing House, March 9, 2020.

A worst-case scenario

Public health experts say that if the COVID-19 epidemic is not successfully contained, it could become a global pandemic, perhaps spreading to 80% of the world's population. With a 1% mortality rate, this would mean that 70 million people would die of the disease. With a 2% mortality rate, the total number of deaths would be twice that number, 140 million people. Comparable numbers of people have died in the tragic wars and pandemics of the past. There is a serious danger that it might happen again.

Biological specificity, the immune system, and vaccines

In the sections below, I will review the history of our developing knowledge concerning biological specificity, and the mechanisms of immune systems. At the end, I will discuss how some innovations in this field might be used to produce an urgently-needed treatment the COVID-19 disease.

1.3 The language of molecular complementarity

In living (and even non-living) systems, signals can be written and read at the molecular level. The language of molecular signals is a language of complementarity. The first scientist to call attention to complementarity and pattern recognition at the molecular level was Paul Ehrlich, who was born in 1854 in Upper Silesia (now a part of Poland). Ehrlich was not an especially good student, but his originality attracted the attention of his teacher, Professor Waldeyer, under whom he studied chemistry at the University of Strasbourg. Waldeyer encouraged him to do independent experiments with the newly-discovered aniline dyes; and on his own initiative, Ehrlich began to use these dyes to stain bacteria. He was still staining cells with aniline dyes a few years later (by this time he had become a medical student at the University of Breslau) when the great bacteriologist Robert Koch visited the laboratory. “This is young Ehrlich, who is very good at staining, but will never pass his examinations”, Koch was told. Nevertheless, Ehrlich did pass his examinations, and he went on to become a doctor of medicine at the University of Leipzig at the age of 24. His doctoral thesis dealt with the specificity of the aniline dyes: Each dye stained a special class of cell and left all other cells unstained.

Paul Ehrlich had discovered what might be called “the language of molecular complementarity”: He had noticed that each of his aniline dyes stained only a particular type of tissue or a particular species of bacteria. For example, when he injected one of his blue dyes into the ear of a rabbit, he found to his astonishment that the dye molecules attached themselves selectively to the nerve endings. Similarly, each of the three types of phagocytes could be stained with its own particular dye, which left the other two kinds unstained¹.

Ehrlich believed that this specificity came about because the side chains on his dye molecules contained groupings of atoms which were complementary to groups of atoms on the surfaces of the cells or bacteria which they selectively stained. In other words, he believed that biological specificity results from a sort of lock and key mechanism: He visualized a dye molecule as moving about in solution until it finds a binding site which exactly fits the pattern of atoms in one of its side chains. Modern research has completely

¹ The specificity which Ehrlich observed in his staining studies made him hope that it might be possible to find chemicals which would attach themselves selectively to pathogenic bacteria in the blood stream and kill the bacteria without harming normal body cells. He later discovered safe cures for both sleeping sickness and syphilis, thus becoming the father of chemotherapy in medicine. He had already received the Nobel Prize for his studies of the mechanism of immunity, but after his discovery of a cure for syphilis, a street in Frankfurt was named after him!

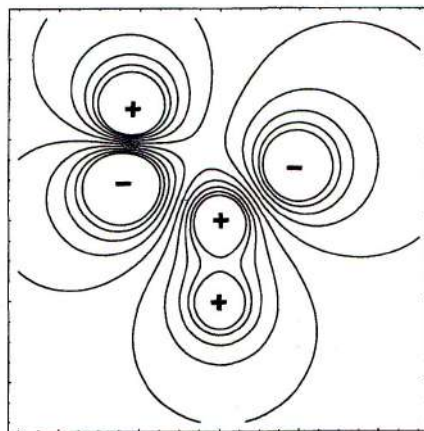

Figure 1.1: This figure shows the excess charges and the resulting electrostatic potential on a molecule of formic acid, HCOOH . The two oxygens in the carboxyl group are negatively charged, while the carbon and the two hydrogens have positive excess charges. Molecular recognition involves not only steric complementarity, but also complementarity of charge patterns.

confirmed this picture, with the added insight that we now know that the complementarity of the “lock” and “key” is electrostatic as well as spatial.

Two molecules in a biological system may fit together because the contours of one are complementary to the contours of the other. This is how Paul Ehrlich visualized the fit - a spatial (steric) complementarity, like that of a lock and key. However, we now know that for maximum affinity, the patterns of excess charges on the surfaces of the two molecules must also be complementary. Regions of positive excess charge on the surface of one molecule must fit closely with regions of negative excess charge on the other if the two are to bind maximally. Thus the language of molecules is not only a language of contours, but also a language of charge distributions.

1.4 Paul Ehrlich, the father of chemotherapy

The first real understanding of the mechanism of the immune system was due to the work of Paul Ehrlich and Ilya Mechnikov, and in 1908 they shared a Nobel Prize for this work. Paul Ehrlich can be said to be the discoverer of biological specificity. As a young medical student at the University of Strasbourg, he was fortunate to work under the distinguished chemist Heinrich von Waldeyer, who took a great interest in Ehrlich. Stimulated by Waldeyer, Ehrlich began to do experiments in which he prepared thin slices of various tissues for microscopic examination by staining them with the newly discovered aniline dyes. During the last half of the 19th century, there was a great deal of interest in histological staining. It was during this period that Walther Flemming in Germany discovered chromosomes by staining them with special dyes, and Christian Gram in Denmark showed that bacteria

can be classified into two types by staining methods. (We now call these two types “gram positive” and “gram negative”). During this same period, and while he was still a student, Paul Ehrlich made the important discovery that mammalian blood contains three different types of white cells which can be distinguished by staining.

Ehrlich’s early work on staining made him famous, and it also gave him a set of theories which led him to his great discoveries in immunology and chemotherapy. According to Ehrlich’s ideas, the color of the aniline dyes is due to the aniline ring. However, dyes used commercially must also adhere to fabrics, and this adherence, according to Ehrlich, is due to the specific structure of the side chains. If the pattern of atoms on a side chain is complementary to the pattern of atoms on the binding site, the dye will adhere, but otherwise not. Thus there is a “lock and key” mechanism, and for this reason dyes with specific side chains stain specific types of tissue.

In one of his experiments, Paul Ehrlich injected methylene blue into the ear of a living rabbit, and found that it stained only the nerve endings of the rabbit. Since the rabbit seemed to be unharmed by the treatment, the experiment suggested to Ehrlich that it might be possible to find antibacterial substances which could be safely injected into the bloodstream of a patient suffering from an infectious disease. Ehrlich hoped to find substances which would adhere selectively to the bacteria, while leaving the tissues of the patient untouched.

With the help of a large laboratory especially constructed for him in Frankfurt, the center of the German dye industry, Ehrlich began to screen thousands of modified dyes and other compounds. In this way he discovered trypan red, a chemical treatment for sleeping sickness, and arsphenamine, a drug which would cure syphilis. Ehrlich thus became the father of modern chemotherapy. His success pointed the way to Gerhard Domagk, who discovered the sulphonamide drugs in the 1930s, and to Fleming, Waksman, Dubos and others, who discovered the antibiotics.

Ehrlich believed that in the operation of the immune system, the body produces molecules which have a pattern of atoms complementary to patterns (antigens) on invading bacteria, and that these molecules (antibodies) in the blood stream kill the bacteria by adhering to them.



Figure 1.2: Paul Ehrlich (1854-1915). By the time that he developed a drug that could cure syphilis, he had already received the Nobel Prize for Physiology or Medicine, but to further honor Ehrlich, a street in Frankfurt was named after him



Figure 1.3: Dr. Paul Ehrlich and his assistant Dr. Sahachiro Hata. They worked together to find cures for many diseases.



Figure 1.4: A West German postage stamp (1954) commemorating Paul Ehrlich and Emil von Behring, who worked together at Robert Koch's suggestion, producing a drug that could cure diphtheria.

1.5 Mechnikov

Meanwhile, the Russian naturalist Ilya Mechnikov discovered another mechanism by which the immune system operates. While on vacation in Sicily, Mechnikov was studying the digestive process in starfish larvae. In order to do this, he introduced some particles of carmine into the larvae. The starfish larvae were completely transparent, and thus Mechnikov could look through his microscope and see what happened to the particles. He saw that they were enveloped and apparently digested by wandering amoebalike cells inside the starfish larvae. As he watched this process, it suddenly occurred to Mechnikov that our white cells might similarly envelop and digest bacteria, thus protecting us from infection. Describing this discovery, Mechnikov wrote in his diary: “I suddenly became a pathologist! Feeling that there was in this idea something of surpassing interest, I became so excited that I began striding up and down the room, and even went to the seashore to collect my thoughts.”

Mechnikov later named the white cells “phagocytes” (which means “eating cells”). He was able to show experimentally that phagocytosis (i.e., the envelopment and digestion of bacteria by phagocytes) is an important mechanism in immunity.

Metchnikov’s ideas were not immediately accepted. Wikipedia states that “His theory, that certain white blood cells could engulf and destroy harmful bodies such as bacteria, met with scepticism from leading specialists including Louis Pasteur, Behring and others. At the time, most bacteriologists believed that white blood cells ingested pathogens and then spread them further through the body. His major supporter was Rudolf Virchow, who published his research in his *Archiv für pathologische Anatomie und Physiologie und für klinische Medizin* (now called the Virchows Archiv). His discovery of these phagocytes ultimately won him the Nobel Prize in 1908.”

For a number of years, there were bitter arguments between those who thought that the immune system operates through phagocytosis, and those who thought that it operates through antibodies. Finally it was found that both mechanisms play a role. In phagocytosis, the bacterium will not be ingested by the phagocyte unless it is first studded with antibodies. Thus both Mechnikov and Ehrlich were proved to be right.

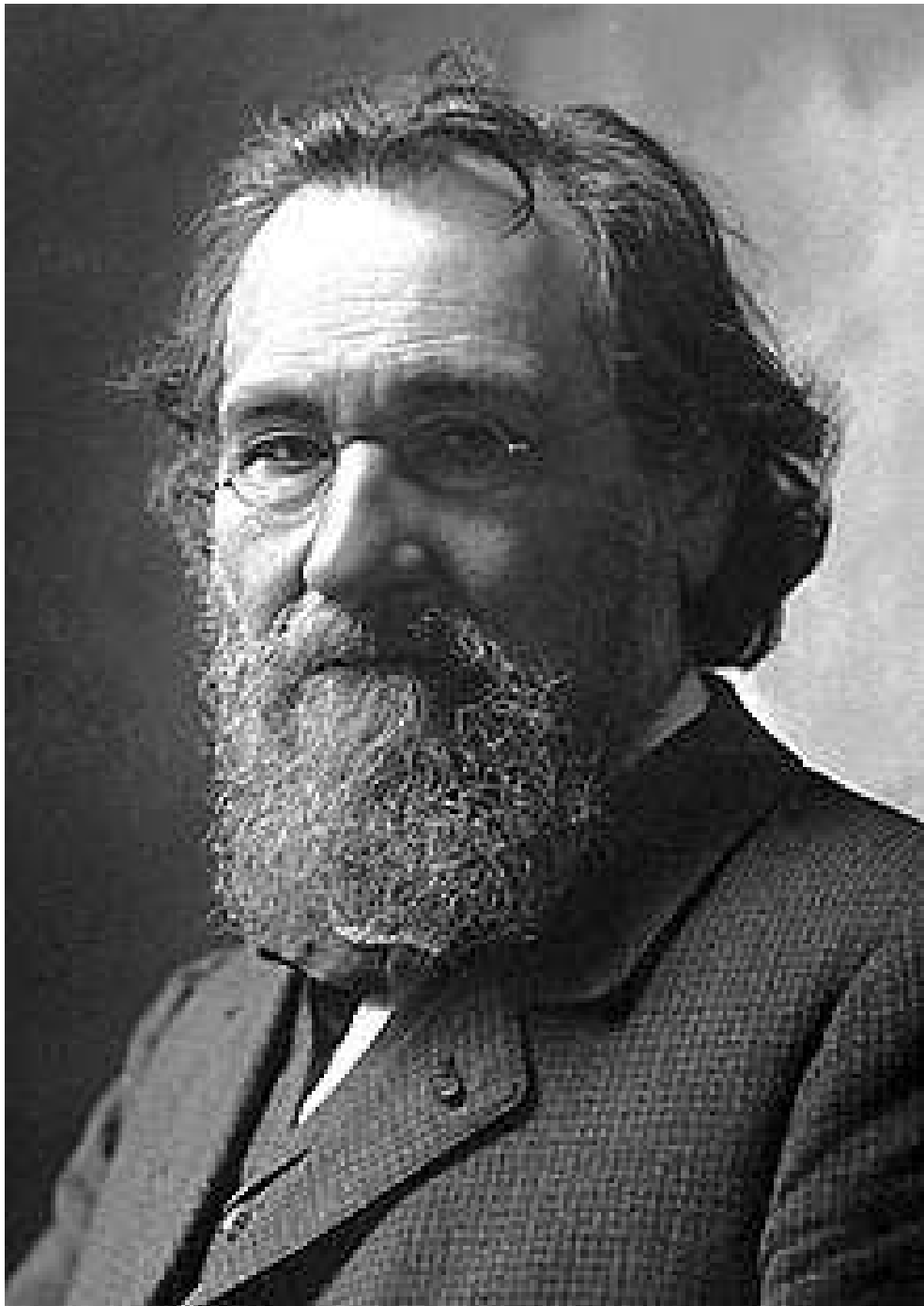

Figure 1.5: Ilya Mechnikov (1845-1916), sometimes spelled *Élie Metchnikoff*. He shared the 1908 Nobel Prize in Physiology or Medicine with Paul Ehrlich. Mechnikov has been called “the father of immunology” because of his discovery of phagocytosis.

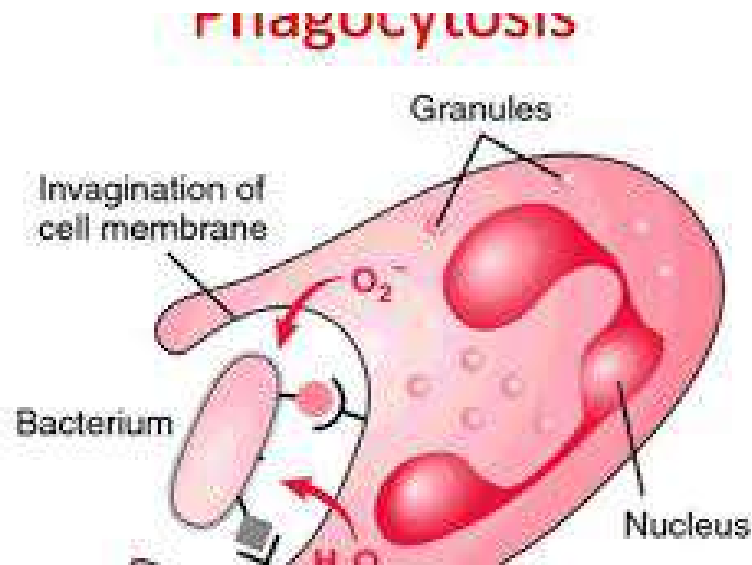

Figure 1.6: Phagocytosis: A lymphocyte “eats” a bacterium, but only if it is coated with the right antigens.

1.6 Burnet, Jerne and the clonal theory of immunity

As everyone knows, recovery from an infectious disease involves a response of our immune systems. Recovery occurs after the immune system has had some time to respond, and a recovered patient generally has some immunity to the disease.

During the 20th century, there were conflicting ideas about how and why this process occurs. One of these theories was proposed by Linus Pauling, who thought that an antigen on the surface of a bacteria or virus provides a template, and that the immune system uses this template to produce the specific antibodies needed to combat the disease. However, experimental evidence accumulated showing Pauling’s template theory to be wrong and supporting the clonal theory of immunity proposed by Sir Frank Macfarlane Burnet and Niels Kai Jerne.

According to the clonal theory of immunity, there are extremely many strains of lymphocytes, each of which produces a specific single antibody. Populations of all these many strains are always present in small numbers. When a patient becomes ill with an infection, the antigens of the ingesting bacteria or virus stimulate one specific strain of lymphocyte to reproduce itself in large numbers, i.e. to become a clone. This large population produces exactly the right antibodies needed to combat the disease, and the large population remains after recovery, conferring continued immunity.

In order for the immune system not to attack the cells of our own bodies, a learning process must take place, early in our lives, in which the difference between self and non-self is established, and the lymphocyte strains that attack self are suppressed. Jerne postulated (correctly) that this learning process takes place in the thymus gland, which is very large in infants, and much smaller in adults.



Figure 1.7: Sir Frank Macfarlane Burnet (1899-1995). Both he and Niels Kai Jerne proposed the clonal theory of immunity.



Figure 1.8: **The Danish immunologist Niels Kai Jerne (1911-1994). He shared the 1984 Nobel Prize for Physiology or Medicine with Georges Köhler and César Milstein “for theories concerning the specificity in development and control of the immune system and the discovery of the principle for production of monoclonal antibodies”.**

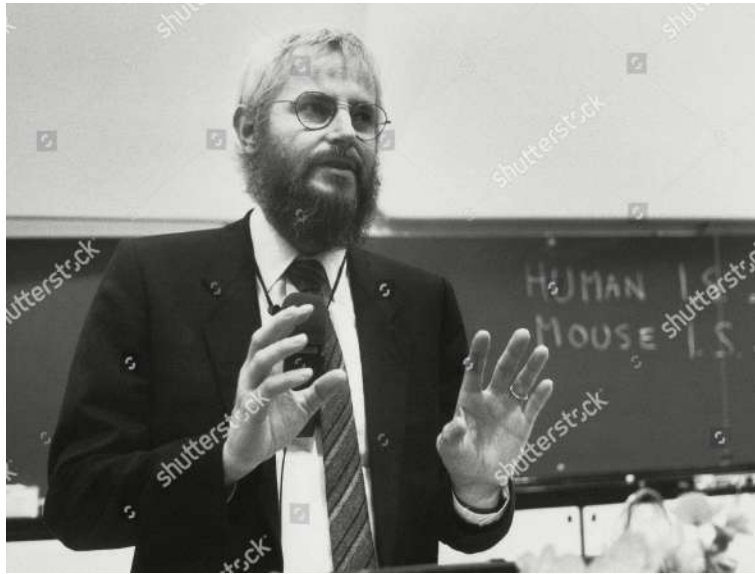

Figure 1.9: Georges Köhler (1946-1995).



Figure 1.10: César Milstein (1927-2002).

1.7 Köhler, Milstein and monoclonal antibodies

Once the clonal theory of immunity became established, the way seemed open to clone *in vitro* B lymphocytes of a predetermined specificity. However, such clone cannot be made to live forever because like all other cells, except cancer cells, they are subject to “programed cell death”. To overcome this difficulty, Georges Köhler and César Milstein found a way to give the desired lymphocytes immortality by fusing them with myeloma cells, thus producing clones that could be cultured indefinitely.

The Wikipedia article on Monoclonal Antibodies states that “In the 1970s, the B-cell cancer multiple myeloma was known. It was understood that these cancerous B-cells all produce a single type of antibody (a paraprotein). This was used to study the structure of antibodies, but it was not yet possible to produce identical antibodies specific to a given antigen.

“In 1975, Georges Köhler and César Milstein succeeded in making fusions of myeloma cell lines with B cells to create hybridomas that could produce antibodies, specific to known antigens and that were immortalized. They and Niels Kaj Jerne shared the Nobel Prize in Physiology or Medicine in 1984 for the discovery.

“In 1988, Greg Winter and his team pioneered the techniques to humanize monoclonal antibodies, eliminating the reactions that many monoclonal antibodies caused in some patients.

“In 2018, James P. Allison and Tasuku Honjo received the Nobel Prize in Physiology or Medicine for their discovery of cancer therapy by inhibition of negative immune regulation, using monoclonal antibodies that prevent inhibitory linkages.”

1.8 Molecular biology and genetic engineering

Classical genetics

Charles Darwin postulated that natural selection acts on small inheritable variations in the individual members of a species. His opponents objected that these slight variations would be averaged away by interbreeding. Darwin groped after an answer to this objection, but he did not have one. However, unknown to Darwin, the answer had been uncovered several years earlier by an obscure Augustinian monk, Gregor Mendel, who was born in Silesia in 1822, and who died in Bohemia in 1884.

Mendel loved both botany and mathematics, and he combined these two interests in his hobby of breeding peas in the monastery garden. Mendel carefully self-pollinated his pea plants, and then wrapped the flowers to prevent pollination by insects. He kept records of the characteristics of the plants and their offspring, and he found that dwarf peas always breed true - they invariably produce other dwarf plants. The tall variety of pea plants, pollinated with themselves, did not always breed true, but Mendel succeeded in isolating a strain of true-breeding tall plants which he inbred over many generations.

Next he crossed his true-breeding tall plants with the dwarf variety and produced a

generation of hybrids. All of the hybrids produced in this way were tall. Finally Mendel self-pollinated the hybrids and recorded the characteristics of the next generation. Roughly one quarter of the plants in this new generation were true-breeding tall plants, one quarter were true-breeding dwarfs, and one half were tall but not true-breeding.

Gregor Mendel had in fact discovered the existence of dominant and recessive genes. In peas, dwarfism is a recessive characteristic, while tallness is dominant. Each plant has two sets of genes, one from each parent. Whenever the gene for tallness is present, the plant is tall, regardless of whether it also has a gene for dwarfism. When Mendel crossed the pure-breeding dwarf plants with pure-breeding tall ones, the hybrids received one type of gene from each parent. Each hybrid had a tall gene and a dwarf gene; but the tall gene was dominant, and therefore all the hybrids were tall. When the hybrids were self-pollinated or crossed with each other, a genetic lottery took place. In the next generation, through the laws of chance, a quarter of the plants had two dwarf genes, a quarter had two tall genes, and half had one of each kind.

Mendel published his results in the *Transactions of the Brünn Natural History Society* in 1865, and no one noticed his paper². At that time, Austria was being overrun by the Prussians, and people had other things to think about. Mendel was elected Abbot of his monastery; he grew too old and fat to bend over and cultivate his pea plants; his work on heredity was completely forgotten, and he died never knowing that he would one day be considered to be the founder of modern genetics.

In 1900 the Dutch botanist named Hugo de Vries, working on evening primroses, independently rediscovered Mendel's laws. Before publishing, he looked through the literature to see whether anyone else had worked on the subject, and to his amazement he found that Mendel had anticipated his great discovery by 35 years. De Vries could easily have published his own work without mentioning Mendel, but his honesty was such that he gave Mendel full credit and mentioned his own work only as a confirmation of Mendel's laws. Astonishingly, the same story was twice repeated elsewhere in Europe during the same year. In 1900, two other botanists (Correns in Berlin and Tschermak in Vienna) independently rediscovered Mendel's laws, looked through the literature, found Mendel's 1865 paper, and gave him full credit for the discovery.

Besides rediscovering the Mendelian laws for the inheritance of dominant and recessive characteristics, de Vries made another very important discovery: He discovered genetic mutations - sudden unexplained changes of form which can be inherited by subsequent generations. In growing evening primroses, de Vries found that sometimes, but very rarely, a completely new variety would suddenly appear, and he found that the variation could be propagated to the following generations. Actually, mutations had been observed before the time of de Vries. For example, a short-legged mutant sheep had suddenly appeared during the 18th century; and stock-breeders had taken advantage of this mutation to breed sheep that could not jump over walls. However, de Vries was the first scientist to study and describe mutations. He noticed that most mutations are harmful, but that a very few

² Mendel sent a copy of his paper to Darwin; but Darwin, whose German was weak, seems not to have read it.

are beneficial, and those few tend in nature to be propagated to future generations.

After the rediscovery of Mendel's work by de Vries, many scientists began to suspect that chromosomes might be the carriers of genetic information. The word "chromosome" had been invented by the German physiologist, Walther Flemming, to describe the long, threadlike bodies which could be seen when cells were stained and examined through the microscope during the process of division. It had been found that when an ordinary cell divides, the chromosomes also divide, so that each daughter cell has a full set of chromosomes.

The Belgian cytologist, Edouard van Benedin, had shown that in the formation of sperm and egg cells, the sperm and egg receive only half of the full number of chromosomes. It had been found that when the sperm of the father combines with the egg of the mother in sexual reproduction, the fertilized egg again has a full set of chromosomes, half coming from the mother and half from the father. This was so consistent with the genetic lottery studied by Mendel, de Vries and others, that it seemed almost certain that chromosomes were the carriers of genetic information.

The number of chromosomes was observed to be small (for example, each normal cell of a human has 46 chromosomes); and this made it obvious that each chromosome must contain thousands of genes. It seemed likely that all of the genes on a particular chromosome would stay together as they passed through the genetic lottery; and therefore certain characteristics should always be inherited together.

This problem had been taken up by Thomas Hunt Morgan, a professor of experimental zoology working at Columbia University. He found it convenient to work with fruit flies, since they breed with lightning-like speed and since they have only four pairs of chromosomes.

Morgan found that he could raise enormous numbers of these tiny insects with almost no effort by keeping them in gauze-covered glass milk bottles, in the bottom of which he placed mashed bananas. In 1910, Morgan found a mutant white-eyed male fly in one of his milk-bottle incubators. He bred this fly with a normal red-eyed female, and produced hundreds of red-eyed hybrids. When he crossed the red-eyed hybrids with each other, half of the next generation were red-eyed females, a quarter were red-eyed males, and a quarter were white-eyed males. There was not one single white-eyed female! This indicated that the mutant gene for white eyes was on the same chromosome as the gene for the male sex.

As Morgan continued his studies of genetic linkages, however, it became clear that the linkages were not absolute. There was a tendency for all the genes on the same chromosome to be inherited together; but on rare occasions there were "crosses", where apparently a pair of chromosomes broke at some point and exchanged segments. By studying these crosses statistically, Morgan and his "fly squad" were able to find the relative positions of genes on the chromosomes. They reasoned that the probability for a cross to separate two genes should be proportional to the distance between the two genes on the chromosome. In this way, after 17 years of work and millions of fruit flies, Thomas Hunt Morgan and his coworkers were able to make maps of the fruit fly chromosomes showing the positions of the genes.

This work had been taken a step further by Hermann J. Muller, a member of Morgan's

“fly squad”, who exposed hundreds of fruit flies to X-rays. The result was a spectacular outbreak of man-made mutations in the next generation.

“They were a motley throng”, recalled Muller. Some of the mutant flies had almost no wings, others bulging eyes, and still others brown, yellow or purple eyes; some had no bristles, and others curly bristles. Muller’s experiments indicated that mutations can be produced by radiation-induced physical damage; and he guessed that such damage alters the chemical structure of genes.

In spite of the brilliant work by Morgan and his collaborators, no one had any idea of what a gene really was.

The structure of DNA

Until 1944, most scientists had guessed that the genetic message was carried by the proteins of the chromosome. In 1944, however, O.T. Avery and his co-workers at the laboratory of the Rockefeller Institute in New York performed a critical experiment, which proved that the material which carries genetic information is not protein, but deoxyribonucleic acid (DNA) - a giant chainlike molecule which had been isolated from cell nuclei by the Swiss chemist, Friedrich Miescher.

Avery had been studying two different strains of pneumococci, the bacteria which cause pneumonia. One of these strains, the S-type, had a smooth coat, while the other strain, the R-type, lacked an enzyme needed for the manufacture of a smooth carbohydrate coat. Hence, R-type pneumococci had a rough appearance under the microscope. Avery and his co-workers were able to show that an extract from heat-killed S-type pneumococci could convert the living R-type species permanently into S-type; and they also showed that this extract consisted of pure DNA.

In 1947, the Austrian-American biochemist, Erwin Chargaff, began to study the long, chainlike DNA molecules. It had already been shown by Levine and Todd that chains of DNA are built up of four bases: adenine (A), thymine (T), guanine (G) and cytosine (C), held together by a sugar-phosphate backbone. Chargaff discovered that in DNA from the nuclei of living cells, the amount of A always equals the amount of T; and the amount of G always equals the amount of C.

When Chargaff made this discovery, neither he nor anyone else understood its meaning. However, in 1953, the mystery was completely solved by Rosalind Franklin and Maurice Wilkins at Kings College, London, together with James Watson and Francis Crick at Cambridge University. By means of X-ray diffraction techniques, Wilkins and Franklin obtained crystallographic information about the structure of DNA. Using this information, together with Linus Pauling’s model-building methods, Crick and Watson proposed a detailed structure for the giant DNA molecule.

The discovery of the molecular structure of DNA was an event of enormous importance for genetics, and for biology in general. The structure was a revelation! The giant, helical DNA molecule was like a twisted ladder: Two long, twisted sugar-phosphate backbones formed the outside of the ladder, while the rungs were formed by the base pairs, A, T, G and C. The base adenine (A) could only be paired with thymine (T), while guanine (G) fit

only with cytosine (C). Each base pair was weakly joined in the center by hydrogen bonds - in other words, there was a weak point in the center of each rung of the ladder - but the bases were strongly attached to the sugar-phosphate backbone. In their 1953 paper, Crick and Watson wrote:

"It has not escaped our notice that the specific pairing we have postulated suggests a possible copying mechanism for genetic material". Indeed, a sudden blaze of understanding illuminated the inner workings of heredity, and of life itself.

If the weak hydrogen bonds in the center of each rung were broken, the ladderlike DNA macromolecule could split down the center and divide into two single strands. Each single strand would then become a template for the formation of a new double-stranded molecule.

Because of the specific pairing of the bases in the Watson-Crick model of DNA, the two strands had to be complementary. T had to be paired with A, and G with C. Therefore, if the sequence of bases on one strand was (for example) TTTGCTAAAGGTGAACCA... , then the other strand necessarily had to have the sequence AAACGATTTCCACTTGGT... The Watson-Crick model of DNA made it seem certain that all the genetic information needed for producing a new individual is coded into the long, thin, double-stranded DNA molecule of the cell nucleus, written in a four-letter language whose letters are the bases, adenine, thymine, guanine and cytosine.

The solution of the DNA structure in 1953 initiated a new kind of biology - molecular biology. This new discipline made use of recently-discovered physical techniques - X-ray diffraction, electron microscopy, electrophoresis, chromatography, ultracentrifugation, radioactive tracer techniques, autoradiography, electron spin resonance, nuclear magnetic resonance and ultraviolet spectroscopy. In the 1960's and 1970's, molecular biology became the most exciting and rapidly-growing branch of science.

Protein structure

In England, J.D. Bernal and Dorothy Crowfoot Hodgkin pioneered the application of X-ray diffraction methods to the study of complex biological molecules. In 1949, Hodgkin determined the structure of penicillin; and in 1955, she followed this with the structure of vitamin B12. In 1960, Max Perutz and John C. Kendrew obtained the structures of the blood proteins myoglobin and hemoglobin. This was an impressive achievement for the Cambridge crystallographers, since the hemoglobin molecule contains roughly 12,000 atoms.

The structure obtained by Perutz and Kendrew showed that hemoglobin is a long chain of amino acids, folded into a globular shape, like a small, crumpled ball of yarn. They found that the amino acids with an affinity for water were on the outside of the globular molecule; while the amino acids for which contact with water was energetically unfavorable were hidden on the inside. Perutz and Kendrew deduced that the conformation of the protein - the way in which the chain of amino acids folded into a 3-dimensional structure - was determined by the sequence of amino acids in the chain.

In 1966, D.C. Phillips and his co-workers at the Royal Institution in London found the crystallographic structure of the enzyme lysozyme (an egg-white protein which breaks

down the cell walls of certain bacteria). Again, the structure showed a long chain of amino acids, folded into a roughly globular shape. The amino acids with hydrophilic groups were on the outside, in contact with water, while those with hydrophobic groups were on the inside. The structure of lysozyme exhibited clearly an active site, where sugar molecules of bacterial cell walls were drawn into a mouth-like opening and stressed by electrostatic forces, so that bonds between the sugars could easily be broken.

Meanwhile, at Cambridge University, Frederick Sanger developed methods for finding the exact sequence of amino acids in a protein chain. In 1945, he discovered a compound (2,4-dinitrofluorobenzene) which attaches itself preferentially to one end of a chain of amino acids. Sanger then broke down the chain into individual amino acids, and determined which of them was connected to his reagent. By applying this procedure many times to fragments of larger chains, Sanger was able to deduce the sequence of amino acids in complex proteins. In 1953, he published the sequence of insulin. This led, in 1964, to the synthesis of insulin.

The biological role and structure of proteins which began to emerge was as follows: A mammalian cell produces roughly 10,000 different proteins. All enzymes are proteins; and the majority of proteins are enzymes - that is, they catalyze reactions involving other biological molecules. All proteins are built from chainlike polymers, whose monomeric sub-units are the following twenty amino acids: glycine, alanine, valine, isoleucine, leucine, serine, threonine, proline, aspartic acid, glutamic acid, lysine, arginine, asparagine, glutamine, cysteine, methionine, tryptophan, phenylalanine, tyrosine and histidine. These individual amino acid monomers may be connected together into a polymer (called a polypeptide) in any order - hence the great number of possibilities. In such a polypeptide, the backbone is a chain of carbon and nitrogen atoms showing the pattern ...-C-C-N-C-C-N-C-C-N-...and so on. The -C-C-N- repeating unit is common to all amino acids. Their individuality is derived from differences in the side groups which are attached to the universal -C-C-N-group.

Some proteins, like hemoglobin, contain metal atoms, which may be oxidized or reduced as the protein performs its biological function. Other proteins, like lysozyme, contain no metal atoms, but instead owe their biological activity to an active site on the surface of the protein molecule. In 1909, the English physician, Archibald Garrod, had proposed a one-gene-one-protein hypothesis. He believed that hereditary diseases are due to the absence of specific enzymes. According to Garrod's hypothesis, damage suffered by a gene results in the faulty synthesis of the corresponding enzyme, and loss of the enzyme ultimately results in the symptoms of the hereditary disease.

In the 1940's, Garrod's hypothesis was confirmed by experiments on the mold, *Neurospora*, performed at Stanford University by George Beadle and Edward Tatum. They demonstrated that mutant strains of the mold would grow normally, provided that specific extra nutrients were added to their diets. The need for these dietary supplements could in every case be traced to the lack of a specific enzyme in the mutant strains. Linus Pauling later extended these ideas to human genetics by showing that the hereditary disease, sickle-cell anemia, is due to a defect in the biosynthesis of hemoglobin.

RNA and ribosomes

Since DNA was known to carry the genetic message, coded into the sequence of the four nucleotide bases, A, T, G and C, and since proteins were known to be composed of specific sequences of the twenty amino acids, it was logical to suppose that the amino acid sequence in a protein was determined by the base sequence of DNA. The information somehow had to be read from the DNA and used in the biosynthesis of the protein.

It was known that, in addition to DNA, cells also contain a similar, but not quite identical, polynucleotide called ribonucleic acid (RNA). The sugar-phosphate backbone of RNA was known to differ slightly from that of DNA; and in RNA, the nucleotide thymine (T) was replaced by a chemically similar nucleotide, uracil (U). Furthermore, while DNA was found only in cell nuclei, RNA was found both in cell nuclei and in the cytoplasm of cells, where protein synthesis takes place. Evidence accumulated indicating that genetic information is first transcribed from DNA to RNA, and afterwards translated from RNA into the amino acid sequence of proteins.

At first, it was thought that RNA might act as a direct template, to which successive amino acids were attached. However, the appropriate chemical complementarity could not be found; and therefore, in 1955, Francis Crick proposed that amino acids are first bound to an adaptor molecule, which is afterward bound to RNA.

In 1956, George Emil Palade of the Rockefeller Institute used electron microscopy to study subcellular particles rich in RNA (ribosomes). Ribosomes were found to consist of two subunits - a smaller subunit, with a molecular weight one million times the weight of a hydrogen atom, and a larger subunit with twice this weight.

It was shown by means of radioactive tracers that a newly synthesized protein molecule is attached temporarily to a ribosome, but neither of the two subunits of the ribosome seemed to act as a template for protein synthesis. Instead, Palade and his coworkers found that genetic information is carried from DNA to the ribosome by a messenger RNA molecule (mRNA). Electron microscopy revealed that mRNA passes through the ribosome like a punched computer tape passing through a tape-reader. It was found that the adaptor molecules, whose existence Crick had postulated, were smaller molecules of RNA; and these were given the name "transfer RNA" (tRNA). It was shown that, as an mRNA molecule passes through a ribosome, amino acids attached to complementary tRNA adaptor molecules are added to the growing protein chain.

The relationship between DNA, RNA, the proteins and the smaller molecules of a cell was thus seen to be hierarchical: The cell's DNA controlled its proteins (through the agency of RNA); and the proteins controlled the synthesis and metabolism of the smaller molecules.

The genetic code

In 1955, Severo Ochoa, at New York University, isolated a bacterial enzyme (RNA polymerase) which was able join the nucleotides A, G, U and C so that they became an RNA strand. One year later, this feat was repeated for DNA by Arthur Kornberg.

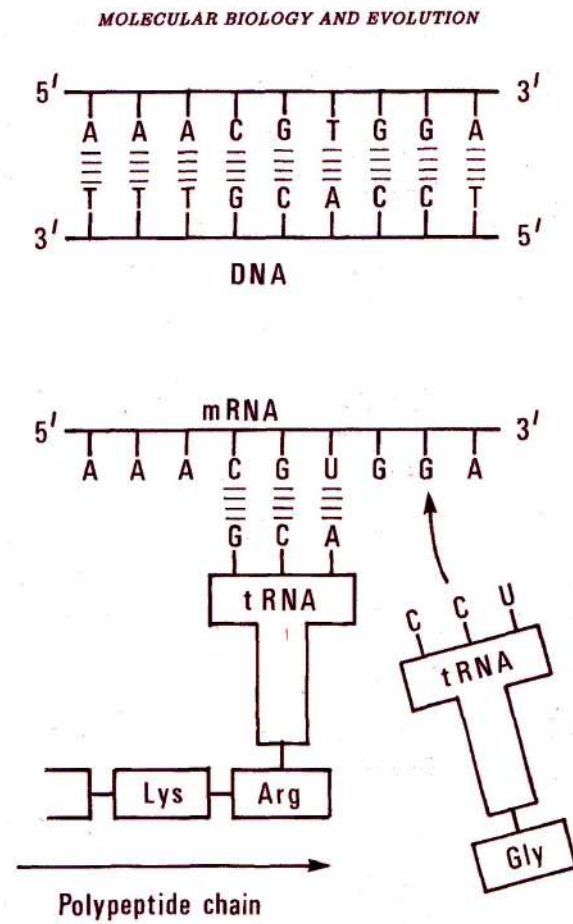

Figure 1.11: Information coded on DNA molecules in the cell nucleus is transcribed to mRNA molecules. The messenger RNA molecules in turn provide information for the amino acid sequence in protein synthesis.

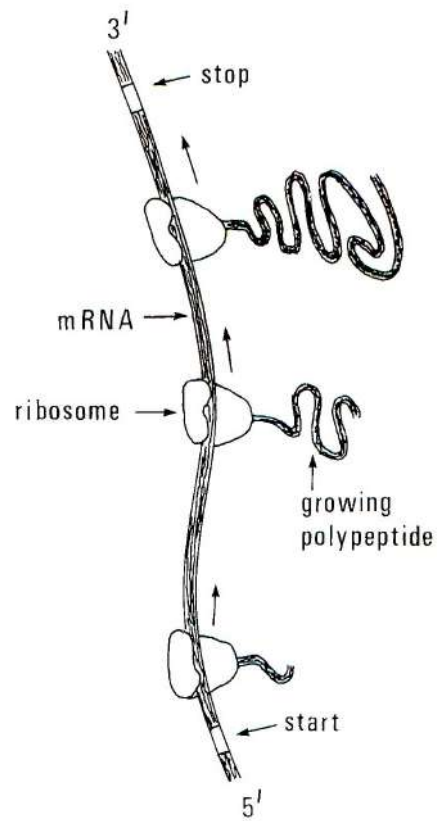

Figure 1.12: mRNA passes through the ribosome like a punched computer tape passing through a tape-reader.

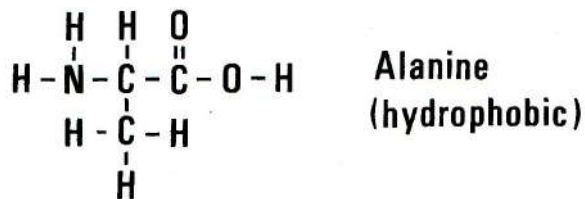
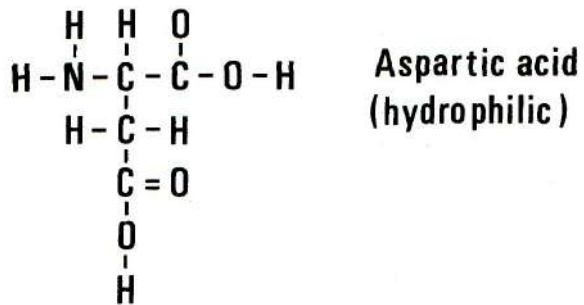
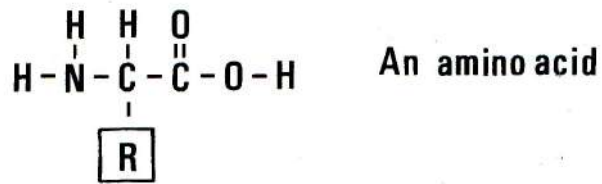

Figure 1.13: This figure shows aspartic acid, whose residue (R) is hydrophilic, contrasted with alanine, whose residue is hydrophobic.

Table 1.1: **The genetic code**

TTT=Phe	TCT=Ser	TAT=Tyr	TGT=Cys
TTC=Phe	TCC=Ser	TAC=Tyr	TGC=Cys
TTA=Leu	TCA=Ser	TAA=Ter	TGA=Ter
TTG=Leu	TGC=Ser	TAG=Ter	TGG=Trp
CTT=Leu	CCT=Pro	CAT=His	CGT=Arg
CTC=Leu	CCC=Pro	CAC=His	CGC=Arg
CTA=Leu	CCA=Pro	CAA=Gln	CGA=Arg
CTG=Leu	CGC=Pro	CAG=Gln	CGG=Arg
ATT=Ile	ACT=Thr	AAT=Asn	AGT=Ser
ATC=Ile	ACC=Thr	AAC=Asn	AGC=Ser
ATA=Ile	ACA=Thr	AAA=Lys	AGA=Arg
ATG=Met	AGC=Thr	AAG=Lys	AGG=Arg
GTT=Val	GCT=Ala	GAT=Asp	GGT=Gly
GTC=Val	GCC=Ala	GAC=Asp	GGC=Gly
GTA=Val	GCA=Ala	GAA=Glu	GGA=Gly
GTG=Val	GGC=Ala	GAG=Glu	GGG=Gly

With the help of Ochoa's enzyme, it was possible to make synthetic RNA molecules containing only a single nucleotide - for example, one could join uracil molecules into the ribonucleic acid chain, ...U-U-U-U-U-U... In 1961, Marshall Nirenberg and Heinrich Matthaei used synthetic poly-U as messenger RNA in protein synthesis; and they found that only polyphenylalanine was synthesized. In the same year, Sydney Brenner and Francis Crick reported a series of experiments on mutant strains of the bacteriophage, T4. The experiments of Brenner and Crick showed that whenever a mutation added or deleted either one or two base pairs, the proteins produced by the mutants were highly abnormal and non-functional. However, when the mutation added or subtracted three base pairs, the proteins often were functional. Brenner and Crick concluded that the genetic language has three-letter words (codons). With four different "letters", A, T, G and C, this gives sixty-four possible codons - more than enough to specify the twenty different amino acids.

In the light of the phage experiments of Brenner and Crick, Nirenberg and Matthaei concluded that the genetic code for phenylalanine is UUU in RNA and TTT in DNA. The remaining words in the genetic code were worked out by H. Gobind Khorana of the University of Wisconsin, who used other mRNA sequences (such as GUGUGU..., AAGAA-GAAG... and GUUGUUGUU...) in protein synthesis. By 1966, the complete genetic code, specifying amino acids in terms of three-base sequences, was known. The code was found to be the same for all species studied, no matter how widely separated they were in form; and this showed that all life on earth belongs to the same family, as postulated by Darwin.

Genetic engineering

In 1970, Hamilton Smith of Johns Hopkins University observed that when the bacterium *Haemophilus influenzae* is attacked by a bacteriophage (a virus parasitic on bacteria), it can defend itself by breaking down the DNA of the phage. Following up this observation, he introduced DNA from the bacterium *E. coli* into *H. influenzae*. Again the foreign DNA was broken down.

Smith had, in fact, discovered the first of a class of bacterial enzymes which came to be called “restriction enzymes” or “restriction nucleases”. Almost a hundred other restriction enzymes were subsequently discovered, and each was found to cut DNA at a specific base sequence. Smith’s colleague, Daniel Nathans, used the restriction enzymes *Hin* *dll* and *Hin* *dill* to produce the first “restriction map” of the DNA in a virus.

In 1971 and 1972, Paul Berg, and his co-workers Peter Lobban, Dale Kaiser and David Jackson at Stanford University, developed methods for adding cohesive ends to DNA fragments. Berg and his group used the calf thymus enzyme, terminal transferase, to add short, single-stranded polynucleotide segments to DNA fragments. For example, if they added the single-stranded segment AAAA to one fragment, and TTTT to another, then the two ends joined spontaneously when the fragments were incubated together. In this way Paul Berg and his group made the first recombinant DNA molecules.

The restriction enzyme *Eco* *RI*, isolated from the bacterium *E. coli*, was found to recognize the pattern, GAATTC, in one strand of a DNA molecule, and the complementary pattern, CTTAAG, in the other strand. Instead of cutting both strands in the middle of the six-base sequence, *Eco* *RI* was observed to cut both strands between G and A. Thus, each side of the cut was left with a “sticky end” - a five-base single-stranded segment, attached to the remainder of the double-stranded DNA molecule.

In 1972, Janet Mertz and Ron Davis, working at Stanford University, demonstrated that DNA strands cut with *Eco* *RI* could be rejoined by means of another enzyme - a DNA ligase. More importantly, when DNA strands from two different sources were cut with *Eco* *RI*, the sticky end of one fragment could form a spontaneous temporary bond with the sticky end of the other fragment. The bond could be made permanent by the addition of DNA ligase, even when the fragments came from different sources. Thus, DNA fragments from different organisms could be joined together.

Bacteria belong to a class of organisms (prokaryotes) whose cells do not have a nucleus. Instead, the DNA of the bacterial chromosome is arranged in a large loop. In the early 1950’s, Joshua Lederberg had discovered that bacteria can exchange genetic information. He found that a frequently-exchanged gene, the F-factor (which conferred fertility), was not linked to other bacterial genes; and he deduced that the DNA of the F-factor was not physically a part of the main bacterial chromosome. In 1952, Lederberg coined the word “plasmid” to denote any extrachromosomal genetic system. In 1959, it was discovered in Japan that genes for resistance to antibiotics can be exchanged between bacteria; and the name “R-factors” was given to these genes. Like the F-factors, the R-factors did not seem to be part of the main loop of bacterial DNA.

Because of the medical implications of this discovery, much attention was focused on

the R-factors. It was found that they are plasmids, small loops of DNA existing inside the bacterial cell but not attached to the bacterial chromosome. Further study showed that, in general, between one percent and three percent of bacterial genetic information is carried by plasmids, which can be exchanged freely even between different species of bacteria.

In the words of the microbiologist, Richard Novick, "Appreciation of the role of plasmids has produced a rather dramatic shift in biologists' thinking about genetics. The traditional view was that the genetic makeup of a species was about the same from one cell to another, and was constant over long periods of time. Now a significant proportion of genetic traits are known to be variable (present in some individual cells or strains, absent in others), labile (subject to frequent loss or gain) and mobile - all because those traits are associated with plasmids or other atypical genetic systems."

In 1973, Herbert Boyer, Stanley Cohen and their co-workers at Stanford University and the University of California carried out experiments in which they inserted foreign DNA segments, cut with Eco RI, into plasmids (also cut with Eco RI). They then resealed the plasmid loops with DNA ligase. Finally, bacteria were infected with the gene-spliced plasmids. The result was a new strain of bacteria, capable of producing an additional protein coded by the foreign DNA segment which had been spliced into the plasmids.

Cohen and Boyer used plasmids containing a gene for resistance to an antibiotic, so that a few gene-spliced bacteria could be selected from a large population by treating the culture with the antibiotic. The selected bacteria, containing both the antibiotic-resistance marker and the foreign DNA, could then be cloned on a large scale; and in this way a foreign gene could be "cloned". The gene-spliced bacteria were chimeras, containing genes from two different species.

The new recombinant DNA techniques of Berg, Cohen and Boyer had revolutionary implications: It became possible to produce many copies of a given DNA segment, so that its base sequence could be determined. With the help of direct DNA-sequencing methods developed by Frederick Sanger and Walter Gilbert, the new cloning techniques could be used for mapping and sequencing genes.

Since new bacterial strains could be created, containing genes from other species, it became possible to produce any protein by cloning the corresponding gene. Proteins of medical importance could be produced on a large scale. Thus, the way was open for the production of human insulin, interferon, serum albumin, clotting factors, vaccines, and protein hormones such as ACTH, human growth factor and leuteinizing hormone.

It also became possible to produce enzymes of industrial and agricultural importance by cloning gene-spliced bacteria. Since enzymes catalyze reactions involving smaller molecules, the production of these substrate molecules through gene-splicing also became possible.

It was soon discovered that the possibility of producing new, transgenic organisms was not limited to bacteria. Gene-splicing was also carried out on higher plants and animals as well as on fungi. It was found that the bacterium *Agrobacterium tumefaciens* contains a tumor-inducing (Ti) plasmid capable of entering plant cells and producing a crown gall. Genes spliced into the Ti plasmid quite frequently became incorporated in the plant chromosome, and afterwards were inherited in a stable, Mendelian fashion.

Transgenic animals were produced by introducing foreign DNA into embryo-derived

stem cells (ES cells). The gene-spliced ES cells were then selected, cultured and introduced into a blastocyst, which afterwards was implanted in a foster-mother. The resulting chimeric animals were bred, and stable transgenic lines selected.

Thus, for the first time, humans had achieved direct control over the process of evolution. Selective breeding to produce new plant and animal varieties was not new - it is one of the oldest techniques of civilization. However, the degree, precision, and speed of intervention which recombinant DNA made possible was entirely new. In the 1970's it became possible to mix the genetic repertoires of different species: The genes of mice and men could be spliced together into new, man-made forms of life!

The Polymerase Chain Reaction

One day in the early 1980's, an American molecular biologist, Kary Mullis, was driving to his mountain cabin with his girl friend. The journey was a long one, and to pass the time, Kary Mullis turned over and over in his mind a problem which had been bothering him: He worked for a California biotechnology firm, and like many other molecular biologists he had been struggling to analyze very small quantities of DNA. Mullis realized that it would be desirable have a highly sensitive way of replicating a given DNA segment - a method much more sensitive than cloning. As he drove through the California mountains, he considered many ways of doing this, rejecting one method after the other as impracticable. Finally a solution came to him; and it seemed so simple that he could hardly believe that he was the first to think of it. He was so excited that he immediately pulled over to the side of the road and woke his sleeping girlfriend to tell her about his idea. Although his girlfriend was not entirely enthusiastic about being wakened from a comfortable sleep to be presented with a lecture on biochemistry, Kary Mullis had in fact invented a technique which was destined to revolutionize DNA technology: the Polymerase Chain Reaction (PCR)³.

The technique was as follows: Begin with a small sample of the genomic DNA to be analyzed. (The sample may be extremely small - only a few molecules.) Heat the sample to 95 °C to separate the double-stranded DNA molecule into single strands. Suppose that on the long DNA molecule there is a target segment which one wishes to amplify. If the target segment begins with a known sequence of bases on one strand, and ends with a known sequence on the complementary strand, then synthetic "primer" oligonucleotides⁴ with these known beginning ending sequences are added in excess. The temperature is then lowered to 50-60 °C, and at the lowered temperature, the "start" primer attaches itself to one DNA strand at the beginning of the target segment, while the "stop" primer becomes attached to the complementary strand at the other end of the target segment. Polymerase (an enzyme which aids the formation of double-stranded DNA) is then added, together with a supply of nucleotides. On each of the original pieces of single-stranded DNA, a new complementary strand is generated with the help of the polymerase. Then

³ The flash of insight didn't take long, but at least six months of hard work were needed before Mullis and his colleagues could convert the idea to reality.

⁴ Short segments of single-stranded DNA.

the temperature is again raised to 95 °C, so that the double-stranded DNA separates into single strands, and the cycle is repeated.

In the early versions of the PCR technique, the polymerase was destroyed by the high temperature, and new polymerase had to be added for each cycle. However, it was discovered that polymerase from the bacterium *Thermus aquaticus* would withstand the high temperature. (*Thermus aquaticus* lives in hot springs.) This discovery greatly simplified the PCR technique. The temperature could merely be cycled between the high and low temperatures, and with each cycle, the population of the target segment doubled, concentrations of primers, deoxynucleotides and polymerase being continuously present.

After a few cycles of the PCR reaction, copies of copies begin to predominate over copies of the original genomic DNA. These copies of copies have a standard length, always beginning on one strand with the start primer, and ending on that strand with the complement of the stop primer.

Two main variants of the PCR technique are possible, depending on the length of the oligonucleotide primers: If, for example, trinucleotides are used as start and stop primers, they can be expected to match the genomic DNA at many points. In that case, after a number of PCR cycles, populations of many different segments will develop. Within each population, however, the length of the replicated segment will be standardized because of the predominance of copies of copies. When the resulting solution is placed on a damp piece of paper or a gel and subjected to the effects of an electric current (electrophoresis), the populations of different molecular weights become separated, each population appearing as a band. The bands are profiles of the original genomic DNA; and this variant of the PCR technique can be used in evolutionary studies to determine the degree of similarity of the genomic DNA of two species.

On the other hand, if the oligonucleotide primers contain as many as 20 nucleotides, they will be highly specific and will bind only to a particular target sequence of the genomic DNA. The result of the PCR reaction will then be a single population, containing only the chosen target segment. The PCR reaction can be thought of as autocatalytic, and as we shall see in the next section, autocatalytic systems play an important role in modern theories of the origin of life.

1.9 A monoclonal antibody against COVID-19

The monoclonal antibody technique of Köhler and Milstein has already been used to produce vaccines against a number of viral diseases. Here are some excerpts from an article by Janice M. Reichert, entitled *Trends in the Development and Approval of Monoclonal Antibodies for Viral Infections*⁵:

⁵Reichert, J.M. Trends in the Development and Approval of Monoclonal Antibodies for Viral Infections. *BioDrugs* 21, 1-7 (2007)

Abstract

Monoclonal antibodies (mAbs) developed for either the prevention or treatment of viral diseases represent a small, but valuable, class of products. Since 1985, commercial firms have initiated clinical studies involving a total of 28 mAbs. To date, one product (palivizumab) has been approved and eight candidates are currently in clinical study.

Most commercial mAbs studied as antiviral agents in the clinic have either directly or indirectly targeted human immunodeficiency virus, respiratory syncytial virus, or hepatitis C virus infections. However, the ability of mAbs to bind to specific targets and utilize various anti-infective modes of action would seem to make them well suited for the prevention and/or treatment of a wider variety of viral diseases. A number of factors, including the continuing need for innovative medicines for viral infections, the global spread of viral infections, and increased government funding for the study of pathogen countermeasures, have prompted companies to reconsider mAbs as antiviral agents. Public sector research into the use of mAbs against emerging pathogens, such as severe acute respiratory syndrome coronavirus, may have already provided candidates for further development.

Antibodies are produced by the immune system to combat invading organisms such as viruses. Prior to the development of monoclonal antibodies (mAbs), polyclonal antibody preparations derived from human serum were used for both prophylaxis and the treatment of a number of viral infections.[1] mAbs, which can be designed to function using various modes of action, seem to be well suited to use as antiviral interventions. However, mAbs are inconvenient to administer compared with oral antibiotics and provide protection from infection for much shorter time periods compared with vaccines. mAbs also tend to be more expensive than either antibiotics or vaccines. As a consequence, in the past mAbs have not been the interventions of choice for infectious diseases. In fact, mAbs for infectious diseases have comprised only

13
To inform future efforts in the research and development of these innovative agents, an overview of trends in the commercial development of mAbs for viral infections, with a focus on mAbs for HIV, RSV, and hepatitis C virus (HCV) infections, is provided, and the possibility of increased efforts to develop mAbs for emerging pathogens is discussed.

Discussion

To date, the majority of commercial clinical development of mAbs for viral infections has focused on products that might meet existing medical needs for new therapies and provide sufficient return on investment. Opportunities of this type exist for numerous viral diseases for which (i) current treatment op-

tions are not optimal; (ii) no effective vaccines are available; and (iii) markets, at least those in the US and Europe, are defined. Examples of agents that meet such criteria are the mAbs directed against HIV, RSV, and HCV infections. Examination of the commercial preclinical pipeline suggests that similar selection criteria have been applied to the majority of candidates that might enter clinical study in the near future. However, in the case of mAbs targeting SCV, the current low incidence of new infections begs the question of whether the preclinical candidates will progress, although as a defensive public health measure, products for these infections should be available.

The current dearth of commercial research and development of mAbs for emerging pathogens might be ameliorated somewhat by:

1. an increased level of government funding available for the development of bioterrorism countermeasures;
2. an emphasis on priority pathogens by the US National Institutes of Health (NIH);
3. the FDA's easing of efficacy requirements in cases where human studies would not be ethical or feasible.

While these factors might indeed bolster the somewhat anemic efforts of industry, the public sector appears to have already responded to the challenge in a more vigorous way. Numerous mAbs for emerging viral diseases are in early research and preclinical stages at academic and government institutions.[38,39] Work has focused on priority pathogens such as Hanta and Ebola viruses that are easily disseminated or transmitted person-to-person, and on emerging pathogens such as Crimean-Congo hemorrhagic fever virus, rabies, and SCV. Importantly, the emphasis has been on development of human mAbs, which, along with humanized products, comprise most of the commercial mAbs now in clinical study.

Ties between the public and private sectors are notoriously intricate.[40] In fact, the preclinical mAbs for SCV and West Nile virus infections attributed here to the commercial sector were all developed with at least some input from the public sector. However, it remains to be seen whether mAbs for infections that occur at high levels only sporadically, or those that would be likely to provide poor return on investment, will be commercialized. MAbs could potentially be critical as a first response measure in the case of a public health crisis, but substantial public sector input might be required to get such products to the market. The NIH's current emphasis on translational medicine might ease the progress of less commercially attractive products through the process of preclinical and clinical development.

Despite obstacles to the development of innovative mAbs for the prophylaxis or treatment of viral diseases, there is reason for cautious optimism. Scientific

advances have uncovered potential new viral targets and mAb modes of action. New possibilities exist for designing safer and more efficacious mAbs. An example of the success potentially achievable with improved design can be found in the case of the mAbs for RSV - felvizumab did not prove efficacious, palivizumab was sufficiently efficacious to be approved, motavizumab shows some improved efficacy compared with palivizumab, and even more potent anti-RSV mAbs can be designed. In addition, increased emphasis from both the public and private sectors on the study of mAbs as viral countermeasures might serve the immediate purpose of providing mAbs useful as either preventative measures or as treatments, but might also provide information potentially useful in the development of vaccines. In either case, the results could greatly benefit public health.

1.10 Mass-production of a COVID-19 antibody

Now suppose that a clone of lymphocytes producing antibodies against the COVID-19 virus has been established. The techniques of genetic engineering described above can then be used to mass-produce the antibody. The specific nucleotide sequence responsible for producing the antibody could be isolated, and then spliced into the plasmid of an easily-cultivated bacterium, or other organism. In this way, large cultures can be made to produce the urgently-needed antibodies for treatment of COVID-19 patients.

1.11 Searching for a vaccine against the COVID-19 virus

Here are some reports of preclinical work from around the world:

- Around 24 January 2020 in Australia, the University of Queensland announced that it is investigating the potential of a molecular clamp vaccine that would genetically modify viral proteins in order to stimulate an immune reaction.
- Around 24 January 2020, the International Vaccine Centre (VIDO-InterVac) at the University of Saskatchewan announced the commencement of work on a vaccine, aiming to start human testing in 2021.
- Vaccine development efforts were announced at the Chinese Center for Disease Control and Prevention,[45] and the University of Hong Kong.
- Around 29 January 2020, Janssen Pharmaceutical Companies, led by Hanneke Schuitemaker, announced that it had begun work on developing a vaccine. Janssen is co-developing an oral vaccine with its biotechnology

partner, Vaxart. On 18 March 2020, Emergent BioSolutions announced a manufacturing partnership with Vaxart to develop the vaccine.[49]

- On 8 February 2020, the laboratory OncoGen in Romania published a paper on the design of an vaccine-design with a similar technology like the one used for cancer neoantigen vaccination therapy” against COVID-19. On 25 March the head of the research institute announced that they finalized the synthesis of the vaccine and that they were beginning the tests.
- On 27 February 2020, a Generex subsidiary company, NuGenerex Immunology announces they were beginning a vaccine project to create an Ii-Key peptide vaccine against COVID-19. They wanted to produce a vaccine candidate that could be tested in humans “within 90 days.”
- Washington University in St. Louis announced its efforts to develop a vaccine on 5 March 2020.
- On 5 March 2020, the United States Army Medical Research and Materiel Command at Fort Detrick and the Walter Reed Army Institute of Research in Silver Spring, both in western Maryland, announced they were working on a vaccine.
- Emergent Biosolutions announced that it had teamed with Novavax Inc. in the development and manufacture of a vaccine. The partners further announced plans for preclinical testing and a Phase I clinical trial by July 2020.
- On 12 March 2020, India’s Health Ministry announced they are working with 11 isolates and that even on a fast track it would take at least around one-and-a-half to two years to develop a vaccine.
- On 12 March 2020, Medicago, a biotechnology company in Quebec City, Quebec, reported development of a coronavirus virus-like particle under partial funding from the Canadian Institutes for Health Research. The vaccine candidate is in laboratory research, with human testing planned for July or August 2020.
- On 16 March 2020, the European Commission offered an 80 million Euro investment in CureVac, a German biotechnology company, to develop a mRNA vaccine. Earlier that week, The Guardian had reported the US President Donald Trump offered CureVac “large sums of money” for exclusive access to a Covid-19 vaccine”, with the German government contesting this effort.

- On 17 March 2020, American pharmaceutical company Pfizer announced a partnership with German company BioNTech to jointly develop a mRNA-based vaccine. mRNA-based vaccine candidate BNT162, currently in pre-clinical testing with clinical trials expected to begin in April 2020.
- In Italy on 17 March 2020, Takis Biotech, an Italian biotech company announced they will have pre-clinical testing results in April 2020 and their final vaccine candidate could begin human testing by fall.
- In France on 19 March 2020, the Coalition for Epidemic Preparedness Innovations (CEPI) announced a US\$4.9 million investment in a COVID-19 vaccine research consortium involving the Institut Pasteur, Themis Bioscience (Vienna, Austria), and the University of Pittsburgh, bringing CEPI's total investment in COVID-19 vaccine development to US\$29 million. CEPI's other investment partners for COVID-19 vaccine development are Moderna, Curevac, Inovio, Novavax, the University of Hong Kong, the University of Oxford, and the University of Queensland.
- On 20 March 2020, Russian health officials announced that scientists have begun animal testing of six different vaccine candidates.
- Imperial College London researchers announced on 20 March 2020 that they are developing a self-amplifying RNA vaccine for COVID-19. The vaccine candidate was developed within 14 days of receiving the sequence from China.
- In late March, the Canadian government announced C\$275 million in funding for 96 research projects on medical countermeasures against COVID-19, including numerous vaccine candidates at Canadian companies and universities, such as the Medicago and University of Saskatchewan initiatives. Around the same time, the Canadian government announced C\$192 million specifically for developing a COVID-19 vaccine, with plans to establish a national "vaccine bank" of several new vaccines that could be used if another coronavirus outbreak occurs.

1.12 Balancing dangers in an emergency

We know with certainty certain that unless a vaccine against the COVID-19 virus is developed quickly and distributed widely, enormous numbers of people will die. Therefore, balancing dangers against each other, and choosing the path most likely to result in a minimum of fatalities, it seems logical to remove some of the hinderences that normally block the rapid development of vaccines.

1. The profit motive must be kept out of the picture. Public funds must be used for research. Considering the enormous economic impact of the pandemic, involving a substantial percentage of the global GDP, the public funds used to develop a vaccine should be proportionately large.
2. Prohibitions against testing on humans must be temporarily lifted. Testing on human volunteers should be allowed.
3. The requirement of years of testing before widespread distribution of the vaccine must be temporarily lifted.
4. Government funds must be used to make the COVID-19 vaccine free for everyone,

Suggestions for further reading

1. Breathnach, C S (September 1984). *Biographical sketches-No. 44. Metchnikoff*. Irish Medical Journal. Ireland. 77 (9).
2. de Kruif, Paul (1996). *Microbe Hunters*. San Diego: A Harvest Book.
3. Deutsch, Ronald M. (1977). *The new nuts among the berries*. Palo Alto, CA: Bull Pub. Co.
4. Fokin, Sergei I. (2008). *Russian scientists at the Naples zoological station, 1874 - 1934*. Napoli: Giannini.
5. Gourko, Helena; Williamson, Donald I.; Tauber, Alfred I. (2000). *The Evolutionary Biology Papers of Elie Metchnikoff*. Dordrecht: Springer Netherlands.
6. Karnovsky, M L (May 1981). *Metchnikoff in Messina: a century of studies on phagocytosis*. N. Engl. J. Med. United States. 304 (19): 1178-80.
7. Lavrova, L N (September 1970). *I. I. Mechnikov and the significance of his legacy for the development of Soviet science (on the 125th anniversary of his birth)*. Zh. Mikrobiol. Epidemiol. Immunobiol. USSR. 47 (9): 3-5.
8. Metchnikoff, Olga (2014) [1921]. *Life of Elie Metchnikoff 1845-1916*. The Floating Press.
9. Schmalstieg Frank C, Goldman Armond S (2008). *Ilya Ilich Metchnikoff (1845-1915) and Paul Ehrlich (1854-1915) The centennial of the 1908 Nobel Prize in Physiology or Medicine*. Journal of Medical Biography. 16 (2): 96-103.
10. Tauber AI (2003). *Metchnikoff and the phagocytosis theory*. Nature Reviews Molecular Cell Biology. 4 (11): 897-901.
11. Tauber, Alfred I.; Chernyak, Leon (1991). *Metchnikoff and the Origins of Immunology: From Metaphor to Theory*. New York: Oxford University Press.
12. Zalkind, Semyon (2001) [1957]. *Ilya Mechnikov: His Life and Work*. The Minerva Group, Inc.
13. Jerne, N. K. (1955). *The Natural-Selection Theory of Antibody Formation* (PDF). Proceedings of the National Academy of Sciences of the United States of America. 41 (11): 849-857.

14. Jerne, N. K. (1974). *Towards a network theory of the immune system*. *Annales d'immunologie*. 125C (1-2): 373-389.
15. Jerne, N.K. (1984), *Nobel lecture: The Generative Grammar of the Immune System* (PDF), Nobelprize.org, retrieved 8 July 2019.
16. Hoffmann, G.W. (1994), *Niels Jerne, Immunologist 1911-1994*, Vaccine Research, Mary Ann Liebert, Inc., 3: 173-174, archived from the original on 6 October 2014.
17. Dubiski, S. (2004). *Science as Autobiography: The Troubled Life of Niels Jerne*. *JAMA: the Journal of the American Medical Association*. 291 (10): 1267.
18. Podolsky, Alfred I. Tauber; Scott H. (1997). *The Generation of Diversity : Clonal Selection Theory and the Rise of Molecular Immunology* (1st paperback ed.). Cambridge, Massachusetts: Harvard Univ. Press.
19. *Biology in Context - The Spectrum of Life* Authors, Peter Aubusson, Eileen Kennedy.
20. Forsdyke D.R. (1995). *The Origins of the Clonal Selection Theory of Immunity*. *FASEB Journal*. 9: 164-66.
21. G. Köhler and C. Milstein (1975). *Continuous cultures of fused cells secreting antibody of predefined specificity*. *Nature*. 256 (5517): 495-7.
22. István Hargittai (2006). *Köhler's Invention*. *Journal Structural Chemistry*. 17 (1)
23. Melchers, F (1995). *Georges Köhler (1946-95)*. *Nature*. 374 (6522) (published Apr 6, 1995). p. 498.
24. Danon, Y L (1996). *Monoclonal antibodies: George Kohler*. *Harefuah*. 130 (2) (published Jan 15, 1996). pp. 108-9.
25. Armstrong, Dorsey (2016). *The Black Death: The World's Most Devastating Plague*. The Great Courses.
26. Benedictow, Ole Jørgen (2004). *Black Death 1346-1353: The Complete History*.
27. Byrne, J. P. (2004). *The Black Death*. London. Greenwood Publishing Group.
28. Cantor, Norman F. (2001). *In the Wake of the Plague: The Black Death and the World It Made*, New York, Free Press.
29. Cohn, Samuel K. Jr., (2002). *The Black Death Transformed: Disease and Culture in Early Renaissance Europe*, London: Arnold.
30. Gasquet, Francis Aidan (1893). *The Great Pestilence AD 1348 to 1349: Now Commonly Known As the Black Death*.
31. Hecker, J.F.C. (1859). B.G. Babington (trans) (ed.). *Epidemics of the Middle Ages*. London: Trä¹/₄bnner.
32. Herlihy, D., (1997). *The Black Death and the Transformation of the West*, Cambridge, Massachusetts: Harvard University Press.
33. McNeill, William H. (1976). *Plagues and Peoples*. Anchor/Doubleday.
34. Scott, S., and Duncan, C. J., (2001). *Biology of Plagues: Evidence from Historical Populations*, Cambridge: Cambridge University Press.
35. Shrewsbury, J. F. D., (1970). *A History of Bubonic Plague in the British Isles*, London: Cambridge University Press.
36. Twigg, G., (1984). *The Black Death: A Biological Reappraisal*, London: Batsford.
37. Ziegler, Philip (1998). *The Black Death*. Penguin Books. 1st editions 1969.

38. H. Lodish, A. Berk, S.L. Zipursky, P. Matsudaira, D. Baltimore, and J. Darnell, *Molecular Cell Biology, 4th Edition*, W.H. Freeman, New York, (2000).
39. Lily Kay, *Who Wrote the Book of Life? A History of the Genetic Code*, Stanford University Press, Stanford CA, (2000).
40. Sahotra Sarkar (editor), *The Philosophy and History of Molecular Biology*, Kluwer Academic Publishers, Boston, (1996).
41. James D. Watson et al. *Molecular Biology of the Gene, 4th Edition*, Benjamin-Cummings, (1988).
42. J.S. Fruton, *Proteins, Enzymes, and Genes*, Yale University Press, New Haven, (1999).
43. S.E. Lauria, *Life, the Unfinished Experiment*, Charles Scribner's Sons, New York (1973).
44. A. Lwoff, *Biological Order*, MIT Press, Cambridge MA, (1962).
45. James D. Watson, *The Double Helix*, Athenium, New York (1968).
46. F. Crick, *The genetic code*, Scientific American, **202**, 66-74 (1962).
47. F. Crick, *Central dogma of molecular biology*, Nature, **227**, 561-563 (1970).
48. David Freifelder (editor), *Recombinant DNA, Readings from the Scientific American*, W.H. Freeman and Co. (1978).
49. James D. Watson, John Tooze and David T. Kurtz, *Recombinant DNA, A Short Course*, W.H. Freeman, New York (1983).
50. Richard Hutton, *Biorevolution, DNA and the Ethics of Man-Made Life*, The New American Library, New York (1968).
51. Martin Ebon, *The Cloning of Man*, The New American Library, New York (1978).
52. Sheldon Krinsky, *Genetic Alchemy: The Social History of the Recombinant DNA Controversy*, MIT Press, Cambridge Mass (1983).
53. M. Lappe, *Germs That Won't Die*, Anchor/Doubleday, Garden City N.Y. (1982).
54. M. Lappe, *Broken Code*, Sierra Club Books, San Francisco (1984).
55. President's Commission for the Study of Ethical Problems in Medicine and Biomedical and Behavioral Research, *Splicing Life: The Social and Ethical Issues of Genetic Engineering with Human Beings*, U.S. Government Printing Office, Washington D.C. (1982).
56. U.S. Congress, Office of Technology Assessment, *Impacts of Applied Genetics - Microorganisms, Plants and Animals*, U.S. Government Printing Office, Washington D.C. (1981).
57. W.T. Reich (editor), *Encyclopedia of Bioethics*, The Free Press, New York (1978).
58. Martin Brown (editor), *The Social Responsibility of the Scientist*, The Free Press, New York (1970).
59. B. Zimmerman, *Biofuture*, Plenum Press, New York (1984).
60. John Lear, *Recombinant DNA, The Untold Story*, Crown, New York (1978).
61. B. Alberts, D. Bray, J. Lewis, M. Raff, K. Roberts and J.D. Watson, *Molecular Biology of the Cell*, Garland, New York (1983).
62. C. Woese, *The Genetic Code; The Molecular Basis for Genetic Expression*, Harper and Row, New York, (1967).

63. F.H.C. Crick, *The Origin of the Genetic Code*, J. Mol. Biol. **38**, 367-379 (1968).
64. M.W. Niernberg, *The genetic code: II*, Scientific American, **208**, 80-94 (1962).
65. L.E. Orgel, *Evolution of the Genetic Apparatus*, J. Mol. Biol. **38**, 381-393 (1968).
66. Melvin Calvin, *Chemical Evolution Towards the Origin of Life, on Earth and Elsewhere*, Oxford University Press (1969).
67. R. Shapiro, *Origins: A Skeptic's Guide to the Origin of Life*, Summit Books, New York, (1986).
68. J. William Schopf, *Earth's earliest biosphere: its origin and evolution*, Princeton University Press, Princeton, N.J., (1983).
69. J. William Schopf (editor), *Major Events in the History of Life*, Jones and Bartlet, Boston, (1992).
70. Robert Rosen, *Life itself: a comprehensive inquiry into the nature, origin and fabrication of life*, Columbia University Press, (1991).
71. R.F. Gesteland, T.R. Cech, and J.F. Atkins (editors), *The RNA World, 2nd Edition*, Cold Spring Harbor Laboratory Press, Cold Spring Harbor, New York, (1999).
72. C. de Duve, *Blueprint of a Cell*, Niel Patterson Publishers, Burlington N.C., (1991).
73. C. de Duve, *Vital Dust; Life as a Cosmic Imperative*, Basic Books, New York, (1995).
74. F. Dyson, *Origins of Life*, Cambridge University Press, (1985).
75. S.A. Kaufman, *Antichaos and adaption*, Scientific American, 265, 78-84, (1991).
76. S.A. Kauffman, *The Origins of Order*, Oxford University Press, (1993).
77. F.J. Varela and J.-P. Dupuy, *Understanding Origins: Contemporary Views on the Origin of Life, Mind and Society*, Kluwer, Dordrecht, (1992).
78. Stefan Bengtson (editor) *Early Life on Earth; Nobel Symposium No. 84*, Columbia University Press, New York, (1994).
79. Herrick Baltscheffsky, *Origin and Evolution of Biological Energy Conversion*, VCH Publishers, New York, (1996).
80. J. Chilea-Flores, T. Owen and F. Raulin (editors), *First Steps in the Origin of Life in the Universe*, Kluwer, Dordrecht, (2001).
81. R.E. Dickerson, Nature **283**, 210-212 (1980).
82. R.E. Dickerson, Scientific American **242**, 136-153 (1980).
83. C.R. Woese, *Archaeobacteria*, Scientific American **244**, 98-122 (1981).
84. N. Iwabe, K. Kuma, M. Hasegawa, S. Osawa and T. Miyata, *Evolutionary relationships of archaeobacteria, eubacteria, and eukaryotes inferred phylogenetic trees of duplicated genes*, Proc. Nat. Acad. Sci. USA **86**, 9355-9359 (1989).
85. C.R. Woese, O. Kundler, and M.L. Wheelis, *Towards a Natural System of Organisms: Proposal for the Domains Archaea, Bacteria and Eucaria*, Proc. Nat. Acad. Sci. USA **87**, 4576-4579 (1990).
86. W. Ford Doolittle, *Phylogenetic Classification and the Universal Tree*, Science, **284**, (1999).
87. G. Wächterhäuser, *Pyrite formation, the first energy source for life: A hypothesis*, Systematic and Applied Microbiology **10**, 207-210 (1988).
88. G. Wächterhäuser, *Before enzymes and templates: Theory of surface metabolism*, Microbiological Reviews, **52**, 452-484 (1988).

89. G. Wächterhäuser, Evolution of the first metabolic cycles, Proc. Nat. Acad. Sci. USA **87**, 200-204 (1990).
90. G. Wächterhäuser, *Groundworks for an evolutionary biochemistry the iron-sulfur world*, Progress in Biophysics and Molecular Biology **58**, 85-210 (1992).
91. M.J. Russell and A.J. Hall, *The emergence of life from iron monosulphide bubbles at a submarine hydrothermal redox and pH front* J. Geol. Soc. Lond. **154**, 377-402, (1997).
92. L.H. Caporale (editor), *Molecular Strategies in Biological Evolution*, Ann. N.Y. Acad. Sci., May 18, (1999).
93. W. Martin and M.J. Russell, *On the origins of cells: a hypothesis for the evolutionary transitions from abiotic geochemistry to chemoautotrophic prokaryotes, and from prokaryotes to nucleated cells*, Philos. Trans. R. Soc. Lond. B Biol. Sci., **358**, 59-85, (2003).
94. Werner Arber, *Elements in Microbial Evolution*, J. Mol. Evol. **33**, 4 (1991).
95. Michael Gray, *The Bacterial Ancestry of Plastids and Mitochondria*, BioScience, **33**, 693-699 (1983).
96. Michael Grey, *The Endosymbiont Hypothesis Revisited*, International Review of Cytology, **141**, 233-257 (1992).
97. Lynn Margulis and Dorian Sagan, *Microcosmos: Four Billion Years of Evolution from Our Microbial Ancestors*, Allan and Unwin, London, (1987).
98. Lynn Margulis and Rene Fester, eds., *Symbiosis as a Source of Evolutionary Innovation: Speciation and Morphogenesis*, MIT Press, (1991).
99. Charles Mann, *Lynn Margulis: Science's Unruly Earth Mother*, Science, **252**, 19 April, (1991).
100. Jan Sapp, *Evolution by Association; A History of Symbiosis*, Oxford University Press, (1994).
101. J.A. Shapiro, *Natural genetic engineering in evolution*, Genetics, **86**, 99-111 (1992).
102. E.M. De Robertis et al., *Homeobox genes and the vertebrate body plan*, Scientific American, July, (1990).
103. J.S. Schrum, T.F. Zhu and J.W. Szostak, *The origins of cellular life*, Cold Spring Harb. Perspect. Biol., May 19 (2010).
104. I. Budin and J.W. Szostak, *Expanding Roles for Diverse Physical Phenomena During the Origin of Life*, Annu. Rev. Biophys., **39**, 245-263, (2010).

Chapter 2

CATASTROPHIC CLIMATE CHANGE

2.1 The climate emergency

Global warming is occurring much faster than the IPCC's scientists expected. The 2020 winter in Europe has been the warmest ever recorded, with February daytime temperatures averaging about 6 degrees C in Copenhagen. On March 3, 2020, the temperature reached 13 degrees C in Moscow, and 14 degrees in Kiev. Normally these two cities would be snowbound at the start of March. Temperatures of 20 degrees C were recorded in Antarctica! The 2018 IPCC Climate Report made it clear that we have only a decade to drastically reduce CO2 emissions. If we fail to do this, irreversible feedback loops will take over and make any human efforts to avoid catastrophe useless. While some governments have responded to this challenge, a number of large greenhouse gas emitters have not. These include the United States, Canada, Brazil, India, China and Saudi Arabia. While India and China have strong renewable energy programs, they are also building many new coal-fired power plants.

2.2 The UK declares a climate emergency

Introducing the motion in the House of Commons, Labour leader Jeremy Corbyn said: **“We have no time to waste. We are living in a climate crisis that will spiral dangerously out of control unless we take rapid and dramatic action now. This is no longer about a distant future. We’re talking about nothing less than the irreversible destruction of the environment within our lifetimes of members of this house.”**

Here are some excerpts from an article by Amy Goodman and Nermeen Shaikh of Democracy Now published in Truthout on May 2, 2019.¹:

¹<https://truthout.org/video/george-monbiot-on-the-uk-climate-emergency/>



On Wednesday, the House of Commons became the first parliament in the world to declare a climate emergency. The resolution came on the heels of the recent Extinction Rebellion mass uprising that shut down Central London last month in a series of direct actions. Activists closed bridges, occupied public landmarks and even superglued themselves to buildings, sidewalks and trains to demand urgent action to combat climate change. Police arrested more than 1,000 protesters. Labour Party Leader Jeremy Corbyn told Parliament, “We are witnessing an unprecedented upsurge of climate activism, with groups like Extinction Rebellion forcing the politicians in this building to listen. For all the dismissive and defensive column inches the processes have provoked, they are a massive and, I believe, very necessary wake-up call. Today we have the opportunity to say, ‘We hear you.’” We speak with George Monbiot, British journalist, author and columnist with *The Guardian*. His recent piece for *The Guardian* is headlined “Only rebellion will prevent an ecological apocalypse.” Monbiot says capitalism “is like a gun pointed at the heart of the planet. It will essentially, necessarily destroy our life-support systems. Among those characteristics is the drive for perpetual economic growth on a finite planet.”

Spain has also recently declared a climate emergency.

2.3 The 2018 IPCC report

Excerpts from an article summarizing the report

Here are excerpts from an article entitled **UN Experts Warn of 'Climate Catastrophe' by 2040** by Jesica Corbett. The article was published in Common Dreams on Monday, October 8, 2018.²:

“The climate crisis is here and already impacting the most vulnerable,” notes 350.org’s program director. “Staying under 1.5°C is now a matter of political will.”

Underscoring the need for “rapid, far-reaching, and unprecedented” changes to life as we know it to combat the global climate crisis, a new report from the Intergovernmental Panel on Climate Change (IPCC) - the United Nations’ leading body for climate science - details what the world could look like if the global temperature rises to 1.5°C versus 2°C (2.7°F versus 3.6°F) above pre-industrial levels, and outlines pathways to reducing greenhouse gas emissions in the context of sustainable development and efforts to eradicate poverty.

“Climate change represents an urgent and potentially irreversible threat to human societies and the planet,” the report reads. “Human-induced warming has already reached about 1°C (1.8°F) above pre-industrial levels at the time of writing of this Special Report... If the current warming rate continues, the world would reach human-induced global warming of 1.5°C around 2040.”

Approved by the IPCC in South Korea on Saturday ahead of COP24 in Poland in December, *Global Warming of 1.5°C* was produced by 91 authors and reviewers from 40 countries. Its release has elicited calls to action from climate campaigners and policymakers the world over.

“This is a climate emergency. The IPCC 1.5 report starkly illustrates the difference between temperature rises of 1.5°C and 2°C - for many around the world this is a matter of life and death,” declared Karin Nansen, chair of Friends of the Earth International (FOEI). “It is crucial to keep temperature rise well below 1.5 degrees ... but the evidence presented by the IPCC shows that there is a narrow and shrinking window in which to do so.”

The report was requested when the international community came together in December of 2015 for the Paris agreement, which aims to keep global warming within this century “well below” 2°C, with an ultimate target of 1.5°C. President Donald Trump’s predecessor supported the accord, but Trump has vowed to withdraw the United States, even as every other nation on the planet has pledged their support for it. In many cases, however, sworn support hasn’t led to effective policy.

²<https://www.commondreams.org/news/2018/10/08/un-experts-warn-climate-catastrophe-2040-without-rapid-and-unprecedented-global>

“It’s a fresh reminder, if one was needed, that current emissions reduction pledges are not enough to meet the long-term goals of the Paris agreement. Indeed, they are not enough for any appropriately ambitious temperature target, given what we know about dangerous climate impacts already unfolding even at lower temperature thresholds,” Rachel Cleetus, lead economist and climate policy manager for the Union of Concerned Scientists (UCS), wrote ahead of its release.

“The policy implications of the report are obvious: We need to implement a suite of policies to sharply limit carbon emissions and build climate resilience, and we must do all this in a way that prioritizes equitable outcomes particularly for the world’s poor and marginalized communities,” Cleetus added.

“We want a just transition to a clean energy system that benefits people not corporations,” Nansen emphasized. “Only with a radical transformation of our energy, food and economic systems, embracing environmental, social, gender and economic justice, can we prevent climate catastrophe and temperature rises exceeding 1.5°C.”

Today we are faced with multiple interrelated crises, for example the threat of catastrophic climate change or equally catastrophic thermonuclear war, and the threat of widespread famine. These threats to human existence and to the biosphere demand a prompt and rational response; but because of institutional and cultural inertia, we are failing to take the steps that are necessary to avoid disaster.

2.4 Greta Thunberg

Only immediate climate action can save the future

Immediate action to halt the extraction of fossil fuels and greatly reduce the emission of CO₂ and other greenhouse gasses is needed to save the long-term future of human civilization and the biosphere.

At the opening ceremony of United Nations-sponsored climate talks in Katowice, Poland, Sir David Attenborough said “Right now, we are facing a man-made disaster of global scale. Our greatest threat in thousands of years. Climate change. If we don’t take action, the collapse of our civilizations and the extinction of much of the natural world is on the horizon. The world’s people have spoken. Their message is clear. Time is running out. They want you, the decision-makers, to act now.”

Antonio Guterres, UN Secretary-General, said climate change was already “a matter of life and death” for many countries. He added that the world is “nowhere near where it needs to be” on the transition to a low-carbon economy.

Swedish student Greta Thunberg, is a 16-year-old who has launched a climate protest movement in her country. She said, in a short but very clear speech after that of UN leader Antonio Guterres: “Some people say that I should be in school instead. Some people say that I should study to become a climate scientist so that I can ‘solve the climate crisis’. But

the climate crisis has already been solved. We already have all the facts and solutions.”

She added: “Why should I be studying for a future that soon may be no more, when no one is doing anything to save that future? And what is the point of learning facts when the most important facts clearly mean nothing to our society?”

Thunberg continued: “Today we use 100 million barrels of oil every single day. There are no politics to change that. There are no rules to keep that oil in the ground. So we can’t save the world by playing by the rules. Because the rules have to be changed.”

She concluded by saying that “since our leaders are behaving like children, we will have to take the responsibility they should have taken long ago.”

Appearing among billionaires, corporate CEO’s and heads of state at the Davos Economic Forum in Switzerland, like a new Joan of Arc, 16-year-old Swedish climate activist Greta Thunberg called on decision-makers to fulfil their responsibilities towards future generations. Here are some excerpts from her speech:

Greta’s speech at Davos

Our house is on fire. I am here to say, our house is on fire. According to the IPCC, we are less than 12 years away from not being able to undo our mistakes. In that time, unprecedented changes in all aspects of society need to have taken place, including a reduction of our CO₂ emissions by at least 50%...

Here in Davos - just like everywhere else - everyone is talking about money. It seems money and growth are our only main concerns.

And since the climate crisis has never once been treated as a crisis, people are simply not aware of the full consequences on our everyday life. People are not aware that there is such a thing as a carbon budget, and just how incredibly small that remaining carbon budget is. That needs to change today.

No other current challenge can match the importance of establishing a wide, public awareness and understanding of our rapidly disappearing carbon budget, that should and must become our new global currency and the very heart of our future and present economics.

We are at a time in history where everyone with any insight of the climate crisis that threatens our civilization - and the entire biosphere - must speak out in clear language, no matter how uncomfortable and unprofitable that may be.

We must change almost everything in our current societies. The bigger your carbon footprint, the bigger your moral duty. The bigger your platform, the bigger your responsibility.



Figure 2.1: Greta Thunberg on the cover of Time Magazine, The Intergovernmental Panel on Climate Change, in their October 2018 report, used strong enough language to wake up at least part of the public: the children whose future is at stake. Here is an excerpt from a speech which 16-year-old Swedish climate activist Greta Thunberg made at the Davos Economic Forum in January, 2019: “Our house is on fire. I am here to say, our house is on fire. According to the IPCC, we are less than 12 years away from not being able to undo our mistakes. In that time, unprecedented changes in all aspects of society need to have taken place, including a reduction of our CO₂ emissions by at least 50%...”

2.5 Worldwide school strike, 15 March, 2019

Over 1.4 million young students across all continents took to the streets on Friday March 15th for the first ever global climate strike. Messages in more than 40 languages were loud and clear: world leaders must act now to address the climate crisis and save our future. The school strike was the largest climate action in history. Nevertheless it went almost unmentioned in the media,

Here are some of the statements by the students explaining why they took part in the strikes:

In India, no one talks about climate change. You don't see it on the news or in the papers or hear about it from government. We want global leaders to declare a climate emergency. If we don't act today, then we will have no tomorrow. - Vidit Baya, 17, Udaipur, India.

We face heartbreaking loss due to increasingly extreme weather events. We urge the Taiwanese government to implement mitigation measures and face up to the vulnerability of indigenous people, halt construction projects in the indigenous traditional realm, and recognize the legal status of Plains Indigenous People, in order to implement environmental protection as a bottom-up approach - Kaisanan Ahuan, Puli City, Taiwan.

We have reached a point in history when we have the technical capacities to solve poverty, malnutrition, inequality and of course global warming. The deciding factors for whether we take advantage of our potential will be our activism, our international unity and our ability to develop the art of making the impossible possible. Whether we succeed or not depends on our political will - Eyal Weintraub, 18, and Bruno Rodriguez, 18, Argentina.

The damage done by multinationals is enormous: the lack of transparency, dubious contracts, the weakening of the soil, the destruction of flora and fauna, the lack of respect for mining codes, the contamination of groundwater. In Mali, the state exercises insufficient control over the practices of the multinationals, and it is us, the citizens, who suffer the consequences. The climate alarm has sounded, and the time has come for us all to realize that there is still time to act locally, in our homes, our villages, our cities - Mone Fousseny, 22, Mali.

2.6 Solar energy

Before the start of the industrial era, human society relied exclusively on renewable energy sources - but can we do so again, with our greatly increased population and greatly

increased demands? Will we ultimately be forced to reduce the global population or our per capita use of energy, or both? Let us now try to examine these questions.

Biomass, wind energy, hydropower and wave power derive their energy indirectly from the sun, but in addition, various methods are available for utilizing the power of sunlight directly. These include photovoltaic panels, solar designs in architecture, solar systems for heating water and cooking, concentrating photovoltaic systems, and solar thermal power plants.

Photovoltaic cells and concentrating photovoltaic systems

Solar power was the fastest-growing source of new energy in 2016, surpassing the net growth of all other energy sources including coal, according to a new report from the International Energy Agency (IEA).

The IEA report found new solar capacity increased by 50 percent in 2016, and IEA executive director Fatih Birol hailed solar's rapid growth. "What we are witnessing is the birth of a new era in solar photovoltaics [PV]. We expect that solar PV capacity growth will be higher than any other renewable technology up to 2022."³

The report also shows renewables as a whole accounted for two-thirds of all new energy capacity in 2016. "We see renewables growing by about 1,000 GW (gigawatts) by 2022, which equals about half of the current global capacity in coal power, which took 80 years to build," Birol said in a statement accompanying the report.⁴

Solar photovoltaic cells⁵ are thin coated wafers of a semiconducting material (usually silicon). The coatings on the two sides are respectively charge donors and charge acceptors. Cells of this type are capable of trapping solar energy and converting it into direct-current electricity. The electricity generated in this way can be used directly (as it is, for example, in pocket calculators) or it can be fed into a general power grid. Alternatively it can be used to split water into hydrogen and oxygen. The gases can then be compressed and stored, or exported for later use in fuel cells. In the future, we may see solar photovoltaic arrays in sun-rich desert areas producing hydrogen as an export product. As their petroleum reserves become exhausted, the countries of the Middle East and Africa may be able to shift to this new technology and still remain energy exporters.

It is interesting to notice that the primary process of photosynthesis in plants is closely similar to the mechanism by which solar cells separate charges and prevent the back-reaction. We can see why a back-reaction must be prevented if we consider the excitation of a single atom. An absorbed photon lifts an electron from a filled atomic orbital to an empty one, leaving a positively-charged hole in the orbital from which the electron came. However, a back-reaction occurs almost immediately: The excited electron falls back into

³<https://www.theguardian.com/environment/2017/oct/04/solar-power-renewables-international-energy-agency>

⁴<https://www.iea.org/newsroom/news/2017/october/solar-pv-grew-faster-than-any-other-fuel-in-2016-opening-a-new-era-for-solar-pow.html>

⁵<https://www.iea.org/renewables/>

the orbital from which it came, and the absorbed energy is re-emitted. One can say that the electron and hole have recombined.

In higher plants, the back reaction is prevented because the photon is absorbed in a membrane which has a sandwich-like structure. Dye molecules (usually chlorophyll molecules) are sandwiched between a layer of charge donor molecules on one side of the membrane, and a layer of charge acceptor molecule on the other side. The electron quickly migrates to the acceptors, which are molecules with low-lying unfilled orbitals. Meanwhile the hole has quickly moved to the opposite side of the membrane, where it combines with an electron from a donor molecule. A donor molecule is a molecule whose highest filled orbital is high in energy. In this process, the back reaction is prevented. The electron and hole are on opposite sides of the membrane, and they can only recombine after they have driven the metabolism of the plant.

In a photovoltaic solar cell, the mechanism by which the back-reaction is prevented is exactly similar. It too has a sandwich-like structure, with charge donors on one side, charge-acceptors on the other, and photon absorbers in the middle. Here too, the electron and hole quickly migrate to opposite sides. They can only recombine by traveling through the external circuit, which is analogous to a plant's metabolism, and performing useful work.

The cost of manufacturing photovoltaics continues to fall rapidly. In 2017, a homeowner paid approximately \$3,360 per kilowatt to have rooftop solar panels installed. Usually photovoltaic panels are warranted for a life of 20 years, but they are commonly still operational after 30 years or more. Using the fact that there are 8760 hours in a year, and thus 175200 hours in 20 years, we can calculate that the cost of electricity to a solar-using homeowner today is about 1.92 cents per kilowatt hour. This can be compared with electricity generated from coal, which in 2011 cost 3.23 cents per kilowatt hour, while electricity generated from natural gas cost 4.51 cents per kilowatt hour. We must also remember that photovoltaics are falling rapidly in price, and that the fossil fuel costs do not include externalities, such as their contribution to climate change.

Concentrating photovoltaic systems are able to lower costs still further by combining silicon solar cells with reflectors that concentrate the sun's rays. The most inexpensive type of concentrating reflector consists of a flat piece of aluminum-covered plastic material bent into a curved shape along one of its dimensions, forming a trough-shaped surface. (Something like this shape results when we hold a piece of paper at the top and bottom with our two hands, allowing the center to sag.) The axis of the reflector can be oriented so that it points towards the North Star. A photovoltaic array placed along the focal line will then receive concentrated sunlight throughout the day.

Photovoltaic efficiency is defined as the ratio of the electrical power produced by a cell to the solar power striking its surface. For commercially available cells today, this ratio is between 9% and 14%. If we assume 5 hours of bright sunlight per day, this means that a photo cell in a desert area near to the equator (where 1 kW/m^2 of peak solar power reaches the earth's surface) can produce electrical energy at the average rate of 20-30 W_e/m^2 , the average being taken over an entire day and night. The potential power per unit area for photovoltaic systems is far greater than for biomass. However, the mix of

renewable energy sources most suitable for a particular country depends on many factors. We will see below that biomass is a promising future source of energy for Sweden, because of Sweden's low population density and high rainfall. By contrast, despite the high initial investment required, photovoltaics are undoubtedly a more promising future energy source for southerly countries with clear skies.

In comparing photovoltaics with biomass, we should be aware of the difference between electrical energy and energy contained in the chemical bonds of a primary fuel such as wood or rapeseed oil. If Sweden (for example) were to supply all its energy needs from biomass, part of the biomass would have to be burned to generate electricity. The efficiency of energy conversion in electricity generation from fuel is 20%-35%. Of course, in dual use power plants, part of the left-over heat from electrical power generation can be used to heat homes or greenhouses. However, hydropower, wind power and photovoltaics have an advantage in generating electrical power, since they do so directly and without loss, whereas generation of electricity from biomass involves a loss from the inefficiency of the conversion from fuel energy to electrical energy. Thus a rational renewable energy program for Sweden should involve a mixture of biomass for heating and direct fuel use, with hydropower and wind power for generation of electricity. Perhaps photovoltaics will also play a role in Sweden's future electricity generation, despite the country's northerly location and frequently cloudy skies.

The global market for photovoltaics is expanding at the rate of 30% per year. This development is driven by rising energy prices, subsidies to photovoltaics by governments, and the realization of the risks associated with global warming and consequent international commitments to reduce carbon emissions. The rapidly expanding markets have resulted in lowered photovoltaic production costs, and hence further expansion, still lower costs, etc. - a virtuous feedback loop.

Solar thermal power plants

Solar Parabolic Troughs can be used to heat a fluid, typically oil, in a pipe running along the focal axis. The heated fluid can then be used to generate electrical power. The liquid that is heated in this way need not be oil. In a solar thermal power plant in California, reflectors move in a manner that follows the sun's position and they concentrate solar energy onto a tower, where molten salt is heated to a temperature of 1050 degrees F (566 °C). The molten salt stores the heat, so that electricity can be generated even when the sun is not shining. The California plant generates 10 MW_e.

Solar designs in architecture

At present, the average global rate of use of primary energy is roughly 2 kW_t per person. In North America, the rate is 12 kW_t per capita, while in Europe, the figure is 6 kW_t. In Bangladesh, it is only 0.2 kW_t. This wide variation implies that considerable energy savings are possible, through changes in lifestyle, and through energy efficiency.



Figure 2.2: A rooftop array of photovoltaic cells.



Figure 2.3: A solar thermal power plant. Arrays of heliostatic reflectors concentrate the sun's rays onto molten salt in the tower. The plant produces electricity at night because the salt remains hot..



Figure 2.4: A solar cooker.



Figure 2.5: A rooftop solar thermal array for domestic water heating.

Important energy savings can be achieved through solar design in architecture. For example, insulation can be improved in walls, and insulating shutters can be closed at night.

In double envelope construction, a weatherproof shell surrounds the inner house. Between the outer shell and the house, sun-heated air circulates. A less extreme example of this principle is the construction of south-facing conservatories. The sun-heated air in the conservatories acts as a thermal buffer, and reduces heat loss from the house.

Solar design aims at making houses cool in the summer and warm in the winter. Awnings can be spread out in the summer to shade windows, and rolled together in the winter to allow sunshine to enter the house. Alternatively, deciduous trees can be planted in front of south-facing windows. During the summer, the leaves of the trees shade the windows, while in the winter, the leaves fall, allowing the sun to enter.

During daylight hours, houses can be illuminated by fiber optic light pipes, connected to a parabolic collector on the roof. The roof can also contain arrays of solar photovoltaic cells and solar water heaters.

Houses can be heated in the winter by heat pumps connected to a deeply buried network of pipes. Heat pumps function in much the same way as refrigerators or air conditioners. When they are used to warm houses in the winter, a volatile liquid such as ammonia is evaporated underground, where the temperature is relatively constant, not changing much between summer and winter. In the evaporation process, heat is absorbed from the ground. The gas is then compressed and re-liquefied within the house, and in this process, it releases the heat that was absorbed underground. Electricity is of course required to drive a heat pump, but far less electrical power is needed to do this than would be required to heat the house directly.

In general, solar design of houses and other buildings requires an initial investment, but over time, the investment is amply repaid through energy savings.

Solar systems for heating water and cooking

Solar heat collectors are already in common use to supply hot water for families or to heat swimming pools. A common form of the solar heat collector consists of a flat, blackened heat-collecting plate to which tubes containing the fluid to be heated are connected. The plate is insulated from the atmosphere by a layer of air (in some cases a partial vacuum) above which there is a sheet of glass. Water flowing through the tubes is collected in a tank whenever it is hotter than the water already there. In cases where there is a danger of freezing, the heated fluid may contain antifreeze, and it may then exchange heat with water in the collection tank. Systems of this kind can function even in climates as unfavorable as that of Northern Europe, although during winter months they must be supplemented by conventional water-heaters.

In the developing countries, wood is often used for cooking, and the result is sometimes deforestation, soil erosion and desertification. In order to supply an alternative, many designs for solar cooking have been developed. Often the designs are very simple, and

many are both easy and inexpensive to build, the starting materials being aluminum foil and cardboard boxes.

2.7 Wind energy

Wind parks in favorable locations, using modern wind turbines, are able to generate $10 \text{ MW}_e/\text{km}^2$ or $10 \text{ W}_e/\text{m}^2$. Often wind farms are placed in offshore locations. When they are on land, the area between the turbines can be utilized for other purposes, for example for pasturage. For a country like Denmark, with good wind potential but cloudy skies, wind turbines can be expected to play a more important future role than photovoltaics. Denmark is already a world leader both in manufacturing and in using wind turbines. Today, on windy days, 100% of all electricity used in Denmark is generated by wind power, and the export of wind turbines makes a major contribution to the Danish economy. The use of wind power is currently growing at the rate of 38% per year. In the United States, it is the fastest-growing form of electricity generation.

The location of wind parks is important, since the energy obtainable from wind is proportional to the cube of the wind velocity. We can understand this cubic relationship by remembering that the kinetic energy of a moving object is proportional to the square of its velocity multiplied by the mass. Since the mass of air moving past a wind turbine is proportional to the wind velocity, the result is the cubic relationship just mentioned.

Before the decision is made to locate a wind park in a particular place, the wind velocity is usually carefully measured and recorded over an entire year. For locations on land, mountain passes are often very favorable locations, since wind velocities increase with altitude, and since the wind is concentrated in the passes by the mountain barrier. Other favorable locations include shorelines and offshore locations on sand bars. This is because onshore winds result when warm air rising from land heated by the sun is replaced by cool marine air. Depending on the season, the situation may be reversed at night, and an offshore wind may be produced if the water is warmer than the land.

The cost of wind-generated electrical power is currently lower than the cost of electricity generated by burning fossil fuels.

The “energy payback ratio” of a power installation is defined as the ratio of the energy produced by the installation over its lifetime, divided by the energy required to manufacture, construct, operate and decommission the installation. For wind turbines, this ratio is 17-39, compared with 11 for coal-burning plants. The construction energy of a wind turbine is usually paid back within three months.

Besides the propeller-like design for wind turbines there are also designs where the rotors turn about a vertical shaft. One such design was patented in 1927 by the French aeronautical engineer Georges Jean Marie Darrieus. The blades of a Darrieus wind turbine are airfoils similar to the wings of an aircraft. As the rotor turns in the wind, the stream of air striking the airfoils produces a force similar to the “lift” of an airplane wing. This force pushes the rotor in the direction that it is already moving. The Darrieus design has some advantages over conventional wind turbine design, since the generator can be placed



Figure 2.6: Rows of wind turbines.



Figure 2.7: Vertical axis wind turbines.



Figure 2.8: **Wind turbines on the Danish island of Samsø** The island was the first in the world to achieve 100% renewable energy.

at the bottom of the vertical shaft, where it may be more easily serviced. Furthermore, the vertical shaft can be lighter than the shaft needed to support a conventional wind turbine.

One problem with wind power is that it comes intermittently, and demand for electrical power does not necessarily come at times when the wind is blowing most strongly. To deal with the problem of intermittency, wind power can be combined with other electrical power sources in a grid. Alternatively, the energy generated can be stored, for example by pumped hydroelectric storage or by using hydrogen technology, as will be discussed below.

Bird lovers complain that birds are sometimes killed by rotor blades. This is true, but the number killed is small. For example, in the United States, about 70,000 birds per year are killed by turbines, but this must be compared with 57 million birds killed by automobiles and 97.5 million killed by collisions with plate glass.

The aesthetic aspects of wind turbines also come into the debate. Perhaps in the future, as wind power becomes more and more a necessity and less a matter of choice, this will be seen as a “luxury argument”.

A Danish island reaches 100% renewable energy

The Danish island of Samsø is only 112 square kilometers in size, and its population numbers only 4,300. Nevertheless, it has a unique distinction. Samsø was the first closed land area to declare its intention of relying entirely on renewable energy, and it has now achieved this aim, provided that one stretches the definitions slightly.

In 1997, the Danish Ministry of Environment and Energy decided to sponsor a renewable-energy contest. In order to enter, communities had to submit plans for how they could make a transition from fossil fuels to renewable energy. An engineer (who didn't live

there) thought he knew how Samsø could do this, and together with the island's mayor he submitted a plan which won the contest. As a result, the islanders became interested in renewable energy. They switched from furnaces to heat pumps, and formed cooperatives for the construction of windmill parks in the sea near to the island. By 2005, Samsø was producing, from renewable sources, more energy than it was using. The islanders still had gasoline-driven automobiles, but they exported from their windmill parks an amount of electrical energy that balanced the fossil fuel energy that they imported. This is a story that can give us hope for the future, although a farming community like Samsø cannot serve as a model for the world.

2.8 Hydroelectric power

In 2015, hydroelectric power supplied 16.6% of all electrical power, and 70% of the electrical power generated from renewable energy. In the developed countries, the potential for increasing this percentage is small, because most of the suitable sites for dams are already in use. Mountainous regions of course have the greatest potential for hydroelectric power, and this correlates well with the fact that virtually all of the electricity generated in Norway comes from hydro, while in Iceland and Austria the figures are respectively 83% and 67%. Among the large hydroelectric power stations now in use are the La Grande complex in Canada (16 GW_e) and the Itapú station on the border between Brazil and Paraguay (14 GW_e). The Three Gorges Dam in China produces 18.2 GW_e .

Even in regions where the percentage of hydro in electricity generation is not so high, it plays an important role because hydropower can be used selectively at moments of peak demand. Pumping of water into reservoirs can also be used to store energy.

The creation of lakes behind new dams in developing countries often involves problems, for example relocation of people living on land that will be covered by water, and loss of the land for other purposes⁶. However the energy gain per unit area of lake can be very large - over 100 W_e/m^2 . Fish ladders can be used to enable fish to reach their spawning grounds above dams. In addition to generating electrical power, dams often play useful roles in flood control and irrigation.

At present, hydroelectric power is used in energy-intensive industrial processes, such as the production of aluminum. However, as the global energy crisis becomes more severe, we can expect that metals derived from electrolysis, such as aluminum and magnesium, will be very largely replaced by other materials, because the world will no longer be able to afford the energy needed to produce them.

⁶Over a million people were displaced by the construction of the Three Gorges Dam in China, and many sites of cultural value were lost

Table 2.1: Technical potential and utilization of hydropower. (Data from World Energy Council, 2003.)

Region	Technical potential	Annual output	Percent used
Asia	0.5814 TW_e	0.0653 TW_e	11%
S. America	0.3187 TW_e	0.0579 TW_e	18%
Europe	0.3089 TW_e	0.0832 TW_e	27%
Africa	0.2155 TW_e	0.0091 TW_e	4%
N. America	0.1904 TW_e	0.0759 TW_e	40%
Oceania	0.0265 TW_e	0.0046 TW_e	17%
World	1.6414 TW_e	0.2960 TW_e	18%



Figure 2.9: Hydroelectric power does not suffer from the problem of intermittency, but may sometimes produce undesirable social and ecological impacts.

2.9 Energy from the ocean

Tidal power

The twice-daily flow of the tides can be harnessed to produce electrical power. Ultimately tidal energy comes from the rotation of the earth and its interaction with the moon's gravitational field. The earth's rotation is very gradually slowing because of tidal friction, and the moon is gradually receding from the earth, but this process will take such an extremely long time that tidal energy can be thought of as renewable.

There are two basic methods for harnessing tidal power. One can build barriers that create level differences between two bodies of water, and derive hydroelectric power from the head of water thus created. Alternatively it is possible to place the blades of turbines in a tidal stream. The blades are then turned by the tidal current in much the same way that the blades of a wind turbine are turned by currents of air.

There are plans for using the second method on an extremely large scale in Cook Strait, near New Zealand. A company founded by David Beach and Chris Bathurst plans to anchor 7,000 turbines to the sea floor of Cook Strait in such a way that they will float 40 meters below the surface. Beach and Bathurst say that in this position, the turbines will be safe from the effects of earthquakes and storms. The tidal flow through Cook Strait is so great that the scheme could supply all of New Zealand's electricity if the project is completed on the scale visualized by its founders.

Choosing the proper location for tidal power stations is important, since the height of tides depends on the configuration of the land. For example, tides of 17 meters occur in the Bay of Fundy, at the upper end of the Gulf of Maine, between New Brunswick and Nova

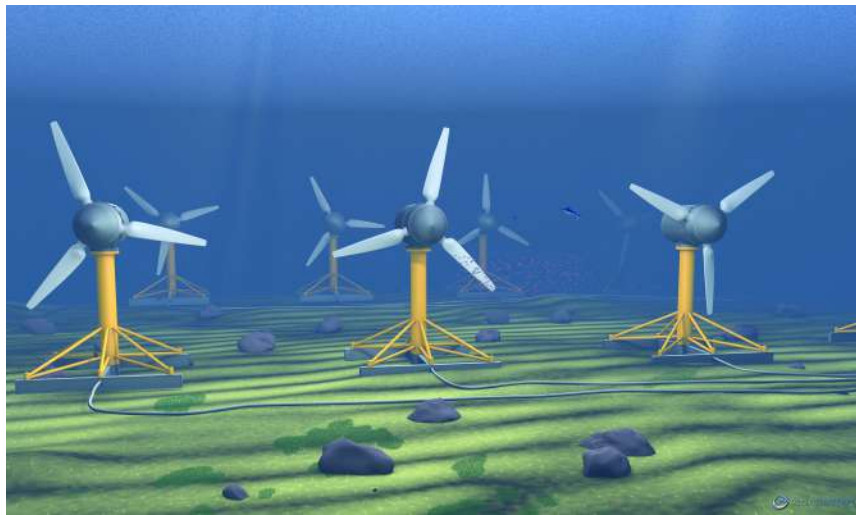

Figure 2.10: **Underwater turbines can make use of the energy of ocean currents.**

Scotia. Here tidal waves are funneled into the bay, creating a resonance that results in the world's greatest level difference between high and low tides. An 18 MW_e dam-type tidal power generation station already exists at Annapolis River, Nova Scotia, and there are proposals to increase the use of tidal power in the Bay of Fundy. Some proposals involve turbines in the tidal stream, similar to those proposed for use in the Cook Strait.

In the future, favorable locations for tidal power may be exploited to their full potentialities, even though the output of electrical energy exceeds local needs. The excess energy can be stored in the form of hydrogen (see below) and exported to regions deficient in renewable energy resources.

Wave energy

At present, the utilization of wave energy is in an experimental stage. In Portugal, there are plans for a wave farm using the Pelamis Wave Energy Converter. The Pelamis is a long floating tube with two or more rigid sections joined by hinges. The tube is tethered with its axis in the direction of wave propagation. The bending between sections resulting from passing waves is utilized to drive high pressure oil through hydraulic motors coupled to electrical generators. Each wave farm in the Portuguese project is planned to use three Pelamis converters, each capable of producing 750 kW_e. Thus the total output of each wave farm will be 2.25 MW_e.

Another experimental wave energy converter is Salter's Duck, invented in the 1970's by Prof. Stephen Salter of the University of Edinburgh, but still being developed and improved. Like the Pelamis, the Duck is also cylindrical in shape, but the axis of the cylinder is parallel to the wave front, i.e. perpendicular to the direction of wave motion. A floating cam, attached to the cylinder, rises and falls as a wave passes, driving hydraulic motors within the cylinder. Salter's Duck is capable of using as much as 65% of the wave's

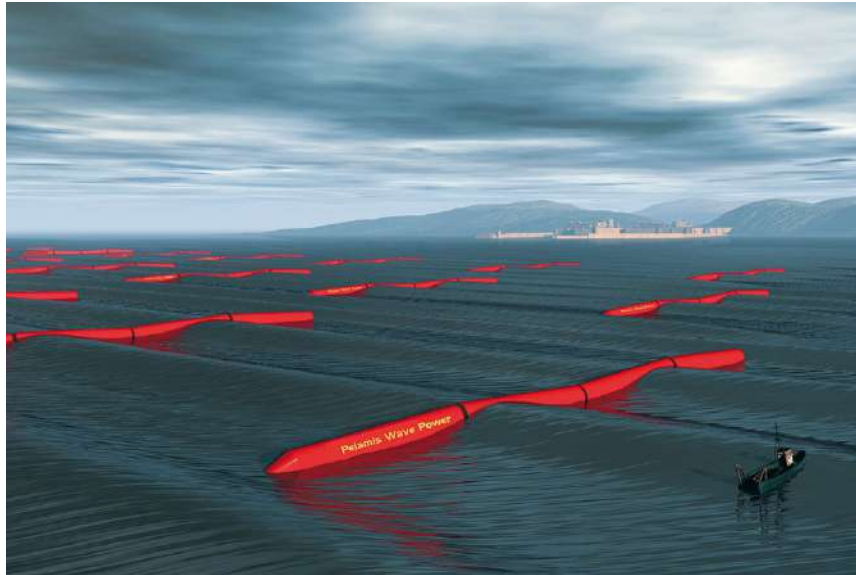

Figure 2.11: The Pelamis wave energy transformer floats on the ocean like a giant sea snake. It consists of several segments which move against each other and build up hydraulic pressure. This in turn drives a turbine. A new Pelamis generation is currently under construction.

energy.

The energy potentially available from waves is very large, amounting to as much as 100 kilowatts per meter of wave front in the best locations.

Ocean thermal energy conversion

In tropical regions, the temperature of water at the ocean floor is much colder than water at the surface. In ocean thermal energy conversion, cold water is brought to the surface from depths as great as 1 km, and a heat engine is run between deep sea water at a very low temperature and surface water at a much higher temperature.

According to thermodynamics, the maximum efficiency of a heat engine operating between a cold reservoir at the absolute temperature T_C and a hot reservoir at the absolute temperature T_H is given by $1 - T_C/T_H$. In order to convert temperature on the centigrade scale to absolute temperature (degrees Kelvin) one must add 273 degrees. Thus the maximum efficiency of a heat engine operating between water at the temperature of 25 °C and water at 5 °C is $1 - (5 + 273)/(25 + 273) = 0.067 = 6.7\%$. The efficiency of heat engines is always less than the theoretical maximum because of various losses, such as the loss due to friction. The actual overall efficiencies of existing ocean thermal energy conversion (OTEC) stations are typically 1-3%. On the other hand, the amount of energy potentially available from differences between surface and bottom ocean temperatures is extremely large.

Since 1974, OTEC research has been conducted by the United States at the Natural

Energy Laboratory of Hawaii. The Japanese government also supports OTEC research, and India has established a 1 MW_e OTEC power station floating in the ocean near to Tamil Nadu.

Renewable energy from evaporation

A September 26, 2017 article by Ahmet-Hamdi Cavusoglu et al. in *Nature Communications* points to evaporation as a future source of renewable energy. Here are some excerpts from the article:

“About 50% of the solar energy absorbed at the Earth’s surface drives evaporation, fueling the water cycle that affects various renewable energy resources, such as wind and hydropower. Recent advances demonstrate our nascent ability to convert evaporation energy into work, yet there is little understanding about the potential of this resource.

“Here we study the energy available from natural evaporation to predict the potential of this ubiquitous resource. We find that natural evaporation from open water surfaces could provide power densities comparable to current wind and solar technologies while cutting evaporative water losses by nearly half. We estimate up to 325 GW of power is potentially available in the United States. Strikingly, water’s large heat capacity is sufficient to control power output by storing excess energy when demand is low, thus reducing intermittency and improving reliability. Our findings motivate the improvement of materials and devices that convert energy from evaporation...

“Recent advances in water responsive materials and devices demonstrate the ability to convert energy from evaporation into work. These materials perform work through a cycle of absorbing and rejecting water via evaporation. These water-responsive materials can be incorporated into evaporation-driven engines that harness energy when placed above a body of evaporating water. With improvements in energy conversion efficiency, such devices could become an avenue to harvest energy via natural evaporation from water reservoirs.”

Ozgur Sahin, a biophysicist at Columbia, has developed technology that uses spores from the harmless soil-dwelling bacterium *B. subtilis* to absorb and release water when the relative humidity of the surrounding air changes. At high humidity, the spores take in water and expand, and at low humidity they release water and contract, acting like a muscle.

2.10 Biomass

Biomass is defined as any energy source based on biological materials produced by photosynthesis - for example wood, sugar beets, rapeseed oil, crop wastes, dung, urban organic wastes, processed sewage, etc. Using biomass for energy does not result in the net emission of CO₂, since the CO₂ released by burning the material had previously been absorbed from the atmosphere during photosynthesis. If the biological material had decayed instead of being burned, it would released the same amount of CO₂ as in the burning process.



Figure 2.12: **Rapeseed is grown in several countries, including Denmark and the UK. Experimental Danish buses are already running on rapeseed oil.**

The solar constant has the value $1.4 \text{ kilowatts/m}^2$. It represents the amount of solar energy per unit area⁷ that reaches the earth, before the sunlight has entered the atmosphere. Because the atmosphere reflects 6% and absorbs 16%, the peak power at sea level is reduced to 1.0 kW/m^2 . Clouds also absorb and reflect sunlight. Average cloud cover reduces the energy of sunlight a further 36%. Also, we must take into account the fact that the sun's rays do not fall perpendicularly onto the earth's surface. The angle that they make with the surface depends on the time of day, the season and the latitude.

In Sweden, which lies at a northerly latitude, the solar energy per unit of horizontal area is less than for countries nearer the equator. Nevertheless, Göran Persson, during his term as Prime Minister of Sweden, announced that his government intends to make the country independent of imported oil by 2020 through a program that includes energy from biomass.

In his thesis, *Biomass in a Sustainable Energy System*, the Swedish researcher Pål Börjesson states that of various crops grown as biomass, the largest energy yields come from short-rotation forests (*Salix viminalis*, a species of willow) and sugar beet plantations. These have an energy yield of from 160 to 170 GJ_t per hectare-year. (The subscript t means "thermal". Energy in the form of electricity is denoted by the subscript e). One can calculate that this is equivalent to about $0.5 \text{ MW}_t/\text{km}^2$, or $0.5 \text{ W}_t/\text{m}^2$. Thus, although 1.0 kW/m^2 of solar energy reaches the earth at noon at the equator, the trees growing in northerly Sweden can harvest a day-and-night and seasonal average of only 0.5 Watts of thermal energy per horizontal square meter⁸. Since Sweden's present primary energy use is approximately 0.04 TW_t , it follows that if no other sources of energy were used, a square area of *Salix* forest 290 kilometers on each side would supply Sweden's present energy needs. This corresponds to an area of $84,000 \text{ km}^2$, about 19% of Sweden's total

⁷The area is assumed to be perpendicular to the sun's rays.

⁸In tropical regions, the rate of biomass production can be more than double this amount.

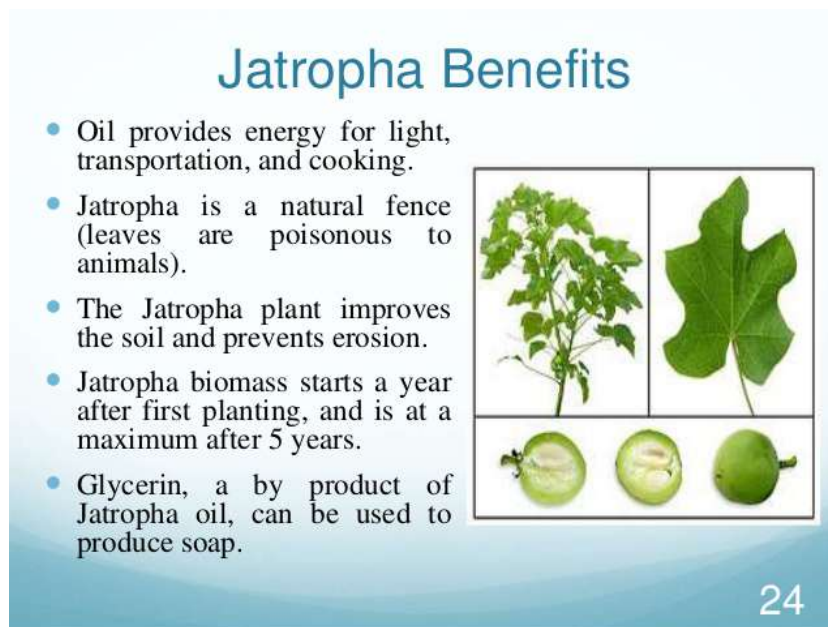

Figure 2.13: In some countries, Jatropha is a promising source of biomass..

area⁹. Of course, Sweden's renewable energy program will not rely exclusively on energy crops, but on a mixture of sources, including biomass from municipal and agricultural wastes, hydropower, wind energy and solar energy.

At present, both Sweden and Finland derive about 30% of their electricity from biomass, which is largely in the form of waste from the forestry and paper industries of these two countries.

Despite their northerly location, the countries of Scandinavia have good potentialities for developing biomass as an energy source, since they have small population densities and adequate rainfall. In Denmark, biodiesel oil derived from rapeseed has been used as fuel for experimental buses. Rapeseed fields produce oil at the rate of between 1,000 and 1,300 liters per hectare-crop. The energy yield is 3.2 units of fuel product energy for every unit of fuel energy used to plant the rapeseed, and to harvest and process the oil. After the oil has been pressed from rapeseed, two-thirds of the seed remains as a protein-rich residue which can be fed to cattle.

Miscanthus is a grassy plant found in Asia and Africa. Some forms will also grow in Northern Europe, and it is being considered as an energy crop in the United Kingdom. Miscanthus can produce up to 18 dry tonnes per hectare-year, and it has the great advantage that it can be cultivated using ordinary farm machinery. The woody stems are very suitable for burning, since their water content is low (20-30%).

For some southerly countries, honge oil, derived from the plant *Pongamia pinnata* may prove to be a promising source of biomass energy. Studies conducted by Dr. Udishi

⁹Additional land area would be needed to supply the energy required for planting, harvesting, transportation and utilization of the wood.

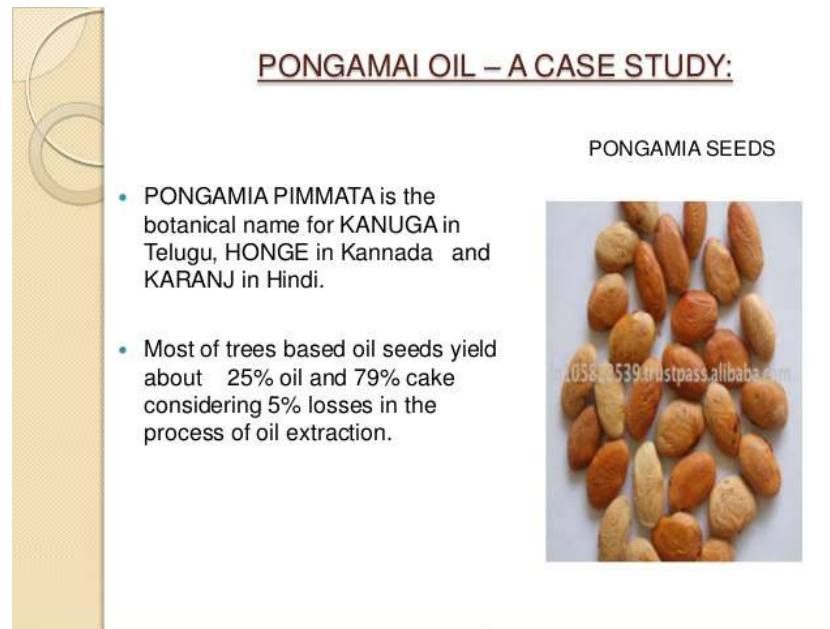

Figure 2.14: **The price of honge oil is quite competitive with other forms of oil.**

Shrinivasa at the Indian Institute of Sciences in Bangalore indicate that honge oil can be produced at the cost of \$150 per ton. This price is quite competitive when compared with other potential fuel oils.

Recent studies have also focused on a species of algae that has an oil content of up to 50%. Algae can be grown in desert areas, where cloud cover is minimal. Farm waste and excess CO₂ from factories can be used to speed the growth of the algae.

It is possible that in the future, scientists will be able to create new species of algae that use the sun's energy to generate hydrogen gas. If this proves to be possible, the hydrogen gas may then be used to generate electricity in fuel cells, as will be discussed below in the section on hydrogen technology. Promising research along this line is already in progress at the University of California, Berkeley.

Biogas is defined as the mixture of gases produced by the anaerobic digestion of organic matter. This gas, which is rich in methane (CH₄), is produced in swamps and landfills, and in the treatment of organic wastes from farms and cities. The use of biogas as a fuel is important not only because it is a valuable energy source, but also because methane is a potent greenhouse gas, which should not be allowed to reach the atmosphere. Biogas produced from farm wastes can be used locally on the farm, for cooking and heating, etc. When biogas has been sufficiently cleaned so that it can be distributed in a pipeline, it is known as "renewable natural gas". It may then be distributed in the natural gas grid, or it can be compressed and used in internal combustion engines. Renewable natural gas can also be used in fuel cells, as will be discussed below in the section on Hydrogen Technology.

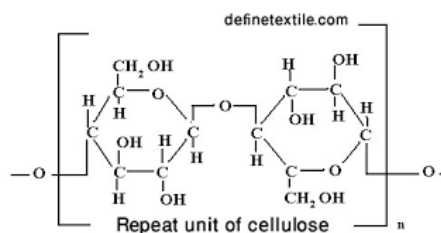

Figure 2.15: Cellulose is a polysaccharide. In other words, it is a long polymer whose subunits are sugars. The links between the sugar subunits in the chain can be broken, for example by the action of enzymes or acids. After this has been done, the resulting sugars can be fermented into alcohols, and these can be used to fuel motor vehicles or aircraft.

Cellulostic ethanol

The fact that alcohols such as ethanol can be produced from cellulose has long been known.¹⁰ In 1819, the French chemist Henri Braconnot demonstrated that cellulose could be broken down into sugars by treating it with sulfuric acid. The sugars thus produced could then be fermented into alcohols which could be used as liquid fuels.

In 1898, Germany built factories to commercialize this process, and shortly afterwards the same was done in the United States using a slightly different technique. These plants producing cellulostic ethanol operated during World War I, but the plants closed after the end of the war because of the cheapness and easy availability of fossil fuels. The production of cellulostic ethanol was revived during World War II.

During the last two decades, development of enzymatic techniques has supplied a better method of breaking the long cellulose polymer chain into sugars. In fact, it has recently become possible to use microbial enzymes both for this step and for the fermentation step.

In a September 9, 2008 article in the *MIT Technology Review*. Prachi Patal wrote: “New genetically modified bacteria could slash the costs of producing ethanol from cellulostic biomass, such as corn cobs and leaves, switchgrass, and paper pulp. The microbes produce ethanol at higher temperatures than are possible using yeast, which is currently employed to ferment sugar into the biofuel. The higher temperature more than halves the quantity of the costly enzymes needed to split cellulose into the sugars that the microbes can ferment. What’s more, while yeast can only ferment glucose, ‘this microorganism is good at using all the different sugars in biomass and can use them simultaneously and rapidly,’ says Lee Lynd, an engineering professor at Dartmouth College, who led the microbe’s development...

“Lynd wants to create microbes that would do it all: efficiently break down the cellulose and hemicellulose, and then ferment all the resulting sugars. Lynd, a cofounder of Mascoma, is working with colleagues at the startup, based in Cambridge, MA, to develop a simple one-step process for making cellulostic ethanol. In the combined process, a mixture of biomass and the microbes would go into a tank, and ethanol would come out.”

Cellulostic ethanol has several advantages over alcohol derived from grain;

¹⁰See the Wikipedia article on *Cellulostic Ethanol*

- Cellulostic ethanol avoids the food-fuel competition.
- The net greenhouse-gas-reducing effect of ethanol derived from grain is questionable.
- Cellulostic ethanol can use cardboard and paper waste as starting substances, thus reducing the quantity of trash in waste dumps.

2.11 Geothermal energy

The ultimate source of geothermal energy is the decay of radioactive nuclei in the interior of the earth. Because of the heat produced by this radioactive decay, the temperature of the earth's core is 4300 °C. The inner core is composed of solid iron, while the outer core consists of molten iron and sulfur compounds. Above the core is the mantle, which consists of a viscous liquid containing compounds of magnesium, iron, aluminum, silicon and oxygen. The temperature of the mantle gradually decreases from 3700 °C near the core to 1000 °C near the crust. The crust of the earth consists of relatively light solid rocks and it varies in thickness from 5 to 70 km.

The outward flow of heat from radioactive decay produces convection currents in the interior of the earth. These convection currents, interacting with the earth's rotation, produce patterns of flow similar to the trade winds of the atmosphere. One result of the currents of molten conducting material in the interior of the earth is the earth's magnetic field. The crust is divided into large sections called "tectonic plates", and the currents of molten material in the interior of the earth also drag the plates into collision with each other. At the boundaries, where the plates collide or split apart, volcanic activity occurs. Volcanic regions near the tectonic plate boundaries are the best sites for collection of geothermal energy.

The entire Pacific Ocean is ringed by regions of volcanic and earthquake activity, the so-called Ring of Fire. This ring extends from Tierra del Fuego at the southernmost tip of South America, northward along the western coasts of both South America and North America to Alaska. The ring then crosses the Pacific at the line formed by the Aleutian Islands, and it reaches the Kamchatka Peninsula in Russia. From there it extends southward along the Kurile Island chain and across Japan to the Philippine Islands, Indonesia and New Zealand. Many of the islands of the Pacific are volcanic in nature. Another important region of volcanic activity extends northward along the Rift Valley of Africa to Turkey, Greece and Italy. In the Central Atlantic region, two tectonic plates are splitting apart, thus producing the volcanic activity of Iceland. All of these regions are very favorable for the collection of geothermal power.

The average rate at which the energy created by radioactive decay in the interior of the earth is transported to the surface is $0.06 \text{ W}_t/\text{m}^2$. However, in volcanic regions near the boundaries of tectonic plates, the rate at which the energy is conducted to the surface is much higher - typically $0.3 \text{ W}_t/\text{m}^2$. If we insert these figures into the thermal conductivity law

$$q = K_T \frac{\Delta T}{z}$$

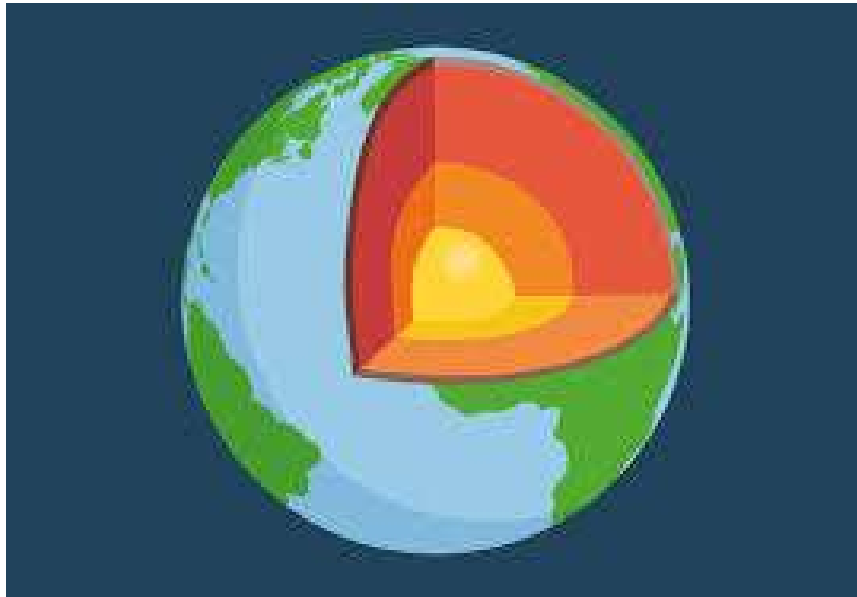

Figure 2.16: The source of geothermal energy is the radioactive decay of elements deep within the earth.



Figure 2.17: The “ring of fire” is especially favorable for geothermal energy installations. The ring follows the western coasts of South America and North America to Alaska, After crossing the Bering Sea, it runs southward past Japan and Indonesia to New Zealand. Earthquakes and volcanic activity along this ring are produced by the collision of tectonic plates. Another strip-like region very favorable for geothermal installations follows Africa’s Rift Valley northward through Turkey and Greece to Italy, while a third pass through Iceland.

we can obtain an understanding of the types of geothermal resources available throughout the world. In the thermal conductivity equation, q is the power conducted per unit area, while K_T is the thermal conductivity of the material through the energy is passing. For sandstones, limestones and most crystalline rocks, thermal conductivities are in the range 2.5-3.5 $W_t/(m \text{ } ^\circ\text{C})$. Inserting these values into the thermal conductivity equation, we find that in regions near tectonic plate boundaries we can reach temperatures of 200 $^\circ\text{C}$ by drilling only 2 kilometers into rocks of the types named above. If the strata at that depth contain water, it will be in the form of highly-compressed steam. Such a geothermal resource is called a *high-enthalpy* resource¹¹.

In addition to high-enthalpy geothermal resources there are *low-enthalpy* resources in nonvolcanic regions of the world, especially in basins covered by sedimentary rocks. Clays and shales have a low thermal conductivity, typically 1-2 $W_t/(m \text{ } ^\circ\text{C})$. When we combine these figures with the global average geothermal power transmission, $q = 0.06 \text{ } W_t/m^2$, the thermal conduction equation tells us that $\Delta T/z = 0.04 \text{ } ^\circ\text{C}/m$. In such a region the geothermal resources may not be suitable for the generation of electrical power, but nevertheless adequate for heating buildings. The Creil district heating scheme north of Paris is an example of a project where geothermal energy from a low enthalpy resource is used for heating buildings.

The total quantity of geothermal electrical power produced in the world today is 8 GW_e , with an additional 16 GW_t used for heating houses and buildings. In the United States alone, 2.7 GW_e are derived from geothermal sources. In some countries, for example Iceland and Canada, geothermal energy is used both for electrical power generation and for heating houses.

There are three methods for obtaining geothermal power in common use today: Deep wells may yield dry steam, which can be used directly to drive turbines. Alternatively water so hot that it boils when brought to the surface may be pumped from deep wells in volcanic regions. The steam is then used to drive turbines. Finally, if the water from geothermal wells is less hot, it may be used in binary plants, where its heat is exchanged with an organic fluid which then boils. In this last method, the organic vapor drives the turbines. In all three methods, water is pumped back into the wells to be reheated. The largest dry steam field in the world is The Geysers, 145 kilometers north of San Francisco, which produces 1,000 MW_e .

There is a fourth method of obtaining geothermal energy, in which water is pumped down from the surface and is heated by hot dry rocks. In order to obtain a sufficiently large area for heat exchange the fissure systems in the rocks must be augmented, for example by pumping water down at high pressures several hundred meters away from the collection well. The European Union has established an experimental station at Soultz-sous-Forêts in the Upper Rhine to explore this technique. The experiments performed at Soultz will determine whether the “hot dry rock” method can be made economically viable. If so, it can potentially offer the world a very important source of renewable energy.

¹¹Enthalpy $\equiv H \equiv U + PV$ is a thermodynamic quantity that takes into account not only the internal energy U of a gas, but also energy PV that may be obtained by allowing it to expand.

The molten lava of volcanoes also offers a potential source of geothermal energy that may become available in the future, but at present, no technology has been developed that is capable of using it.

2.12 Hydrogen technologies

Electrolysis of water

When water containing a little acid is placed in a container with two electrodes and subjected to an external direct current voltage greater than 1.23 Volts, bubbles of hydrogen gas form at one electrode (the cathode), while bubbles of oxygen gas form at the other electrode (the anode). At the cathode, the half-reaction

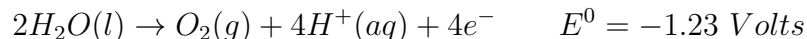

takes place, while at the anode, the half-reaction

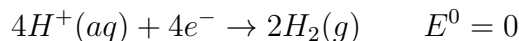

occurs.

Half-reactions differ from ordinary chemical reactions in containing electrons either as reactants or as products. In electrochemical reactions, such as the electrolysis of water, these electrons are either supplied or removed by the external circuit. When the two half-reactions are added together, we obtain the total reaction:

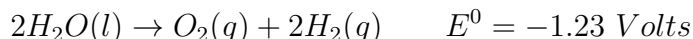

Notice that $4H^+$ and $4e^-$ cancel out when the two half-reactions are added. The total reaction does not occur spontaneously, but it can be driven by an external potential E , provided that the magnitude of E is greater than 1.23 volts.

When this experiment is performed in the laboratory, platinum is often used for the electrodes, but electrolysis of water can also be performed using electrodes made of graphite.

Electrolysis of water to produce hydrogen gas has been proposed as a method for energy storage in a future renewable energy system. For example, it might be used to store energy generated by photovoltaics in desert areas of the world. Compressed hydrogen gas could then be transported to other regions and used in fuel cells. Electrolysis of water and storage of hydrogen could also be used to solve the problem of intermittency associated with wind energy or solar energy.

Half reactions

Chemical reactions in which one or more electrons are transferred are called *oxidation-reduction reactions*. Any reaction of this type can be used in a fuel cell. As an example,

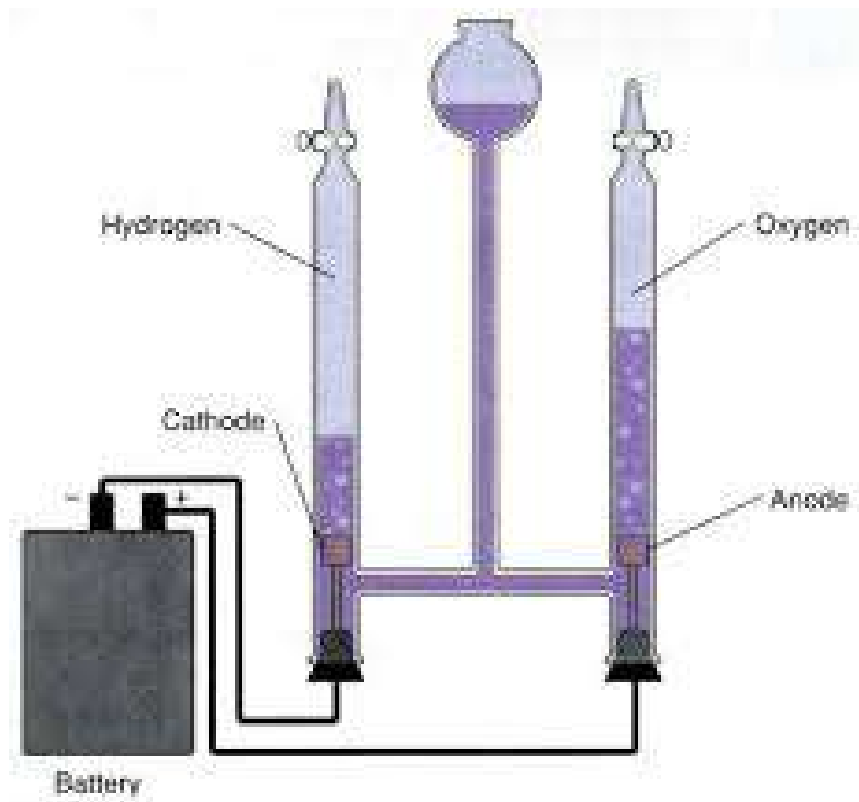

Figure 2.18: Electrolysis of water.

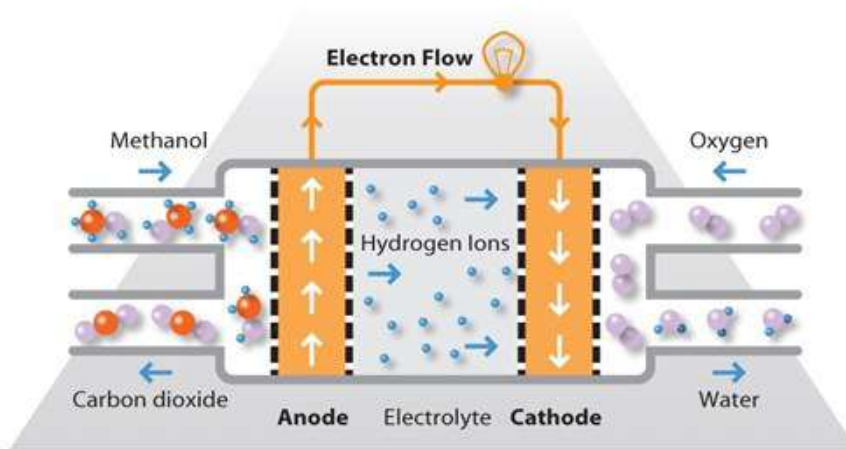
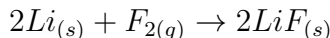

Figure 2.19: A methanol fuel cell.

we can consider the oxidation-reduction reaction in which solid lithium metal reacts with fluorine gas;



This reaction can be split into two half-reactions,



and



The quantity E_0 which characterizes these half-reactions is called *standard potential* of the half-reaction, and it is measured in Volts. If the oxidation-reduction reaction is used as the basis of a fuel cell, the voltage of the cell is the difference between the two standard potentials. In the lithium fluoride example, it is

$$2.87 \text{ V} - (-3.040 \text{ V}) = 5.91 \text{ V}$$

Here are a few more half-reactions and their standard potentials:

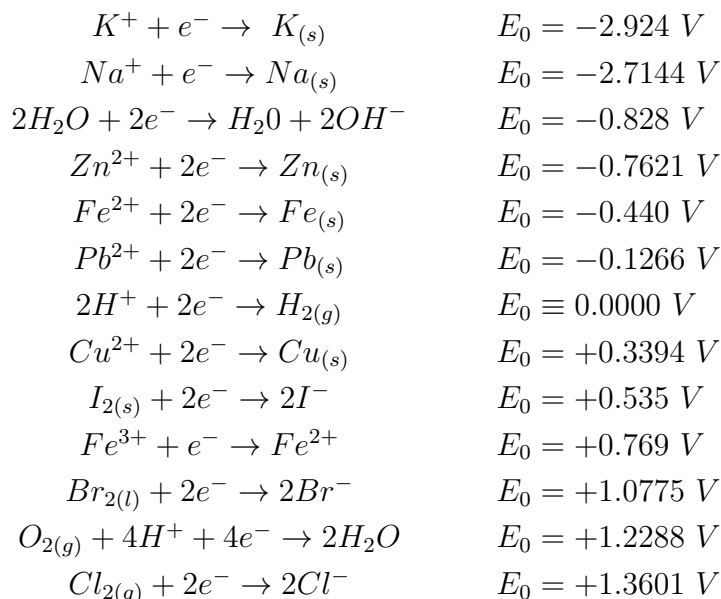

Fuel cells are closely related to storage batteries. Essentially, when we recharge a storage battery we are just running a fuel cell backwards, applying an electrical potential which is sufficient to make a chemical reaction run in a direction opposite to the way that it would run spontaneously. When the charged battery is afterwards used to drive a vehicle or to power an electronic device, the reaction runs in the spontaneous direction, but the energy of the reaction, instead of being dissipated as heat, drives electrons through an external circuit and performs useful work.

2.13 Reducing emissions from the cement industry

The cement industry currently account for 7% of all CO₂ emissions, that is to say, three times as much as air travel. If the cement industry were a country, it would be the third largest emitter, after China and the United States. The reason for this enormous and potentially fatal quantity of CO₂ is twofold. Firstly, in the manufacture of Portland cement, the following reaction occurs:

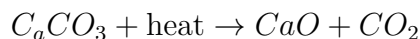

Thus CO₂ is released in the chemical reaction. Secondly, heat is required to heat the limestone (C_aCO₃) and this heat usually comes from the burning of fossil fuels. However there is hope that new experimental methods may be developed which can reduce or even eliminate the dangerous emissions from the global cement industry.¹²

Here are some excerpts from an article entitled *Why Cement Emissions Matter for Climate Change*¹³:

Some companies have been researching “novel” cements, which do away with the need for Portland clinker altogether. If these could rival the cost and performance of Portland cement, they would offer a way to significantly reduce emissions...

Geopolymer-based cements, for example, have been a focus of research since the 1970s. These do not use calcium carbonate as a key ingredient, harden at room temperature and release only water. Zeobond and banahUK are among firms producing these, with both claiming around 80-90% reduction in emissions compared to Portland cement.

There are also several firms developing “carbon-cured” cements, which absorb CO₂, rather than water, as they harden. If this CO₂ absorption can be made higher than CO₂ released during their production, cements could potentially be used as a carbon sink.

US firm Solidia, for example, claims its concrete emits up to 70% less CO₂ than Portland cement, including this sequestering step. The firm is now in a partnership with major cement producer LafargeHolcim.

Similarly, British start-up Novacem - a spin out from Imperial College London - claimed in 2008 that replacing Portland cement with its “carbon negative” product would allow the industry to become a net sink of CO₂ emissions. However, the firm failed to raise sufficient funds to continue research and production.

Other firms are using completely different materials to make cement. North Carolina-based startup Biomason, for example, uses bacteria to grow cement bricks which it says are both similarly strong to traditional masonry and carbon-sequestering.

¹²<https://www.ecowatch.com/scientists-create-living-concrete-2644831492.html>

¹³<https://www.carbonbrief.org/qa-why-cement-emissions-matter-for-climate-change>

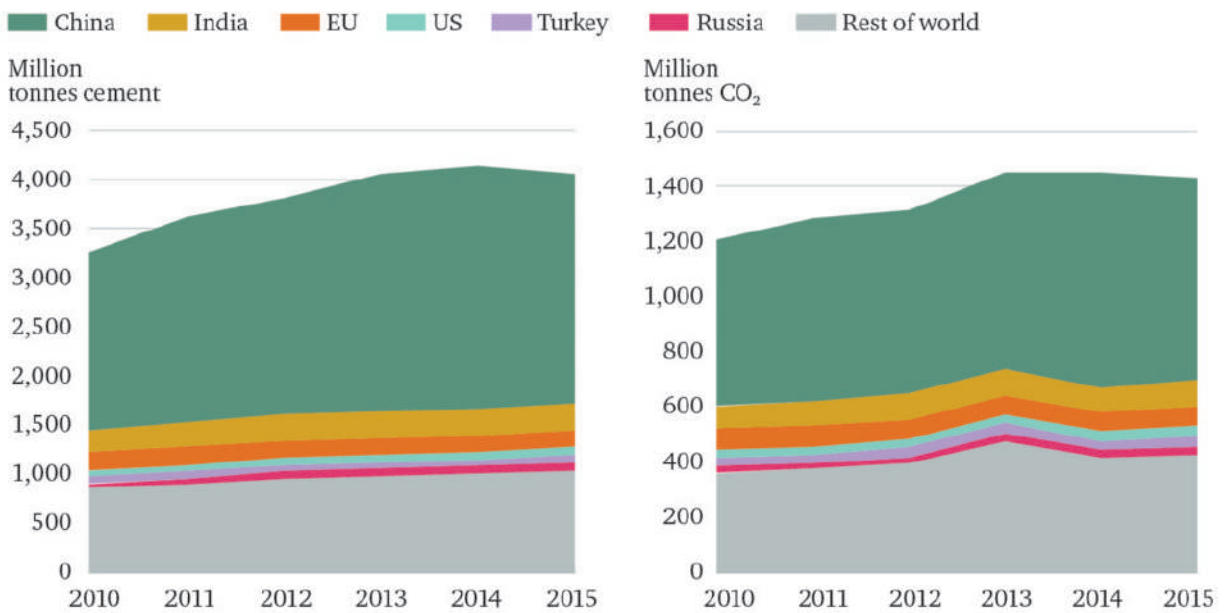

Figure 2.20: China is the largest producer of cement and the associated CO₂ emissions.



Figure 2.21: BioMason uses bacteria to grow cement bricks which it says can sequester carbon. Credit: bioMASON, Inc..

2.14 Reducing emissions from transportation sectors

We are in love with our automobiles, but it is not certain that they make our lives happier. We love our cars so much that we are willing to die (and kill) for them: Wikipedia states that “It is estimated that motor vehicle collisions caused the death of around 60 million people during the 20th century, around the same number of World War II casualties. Just in 2010 alone, 1.23 million people were killed due to traffic collisions.”

Besides being dangerous, automobiles make our cities unpleasant. A pleasant city center is, almost by definition, a car-free one. Today, both tourists and Danish citizens enjoy Copenhagen’s bicycle culture and car-free city center¹⁴, and throughout the world, the pleasantness of cities is inversely proportional to the number of automobiles.

Some people visualize the transition from internal combustion engines to electric vehicles as the only change needed to make transportation environmentally friendly; but this ignores the enormous amount of energy, water (148,000 liters), and other resources needed to manufacture private automobiles. A truly sustainable future requires a transition, wherever possible, from private to public transport.

The government of Luxembourg recently announced that it intends to make all public transportation entirely free¹⁵, thus saving on the collection of fares, and eliminating the massive traffic jams that have plagued the country’s capital. Luxembourg City, the capital of the small Grand Duchy, suffers from some of the worst traffic congestion in the world. It is home to about 110,000 people, but a further 400,000 commute into the city to work. It will be interesting to follow the progress of this enlightened decision, due to take effect in 2020. Hopefully other countries will follow Luxembourg’s example. Luxembourg has increasingly shown a progressive attitude to transport. This summer, the government brought in free transport for every child and young person under the age of 20. Secondary school students can use free shuttles between their institution and their home.

Top Gear is long-running BBC program celebrating the delights of car ownership and motor sport. It is an example of the fact that our mass media actively encourage harmful and unsustainable human behavior. The program appeals to car enthusiasts - people who are passionate about automobiles. How much better it would be if they were passionate about saving human civilization and the biosphere from irreversible feedback loops leading in the long run to catastrophic climate change, mass extinctions, and the collapse of human civilization!

In an article entitled *Why are people so in love with their cars?*¹⁶, Tim Dugan explains why he loves his car:

“This car is bought and paid for by my own hand, it is the first major purchase I ever made as an adult. I worked off the loan and it wholly belongs to me. There is a sense of pride in this. Seeing the fruits of your labor and your saving and scrounging.

¹⁴<https://www.theguardian.com/cities/2016/may/05/story-cities-copenhagen-denmark-modernist-utopia>

¹⁵<https://www.theguardian.com/world/2018/dec/05/luxembourg-to-become-first-country-to-make-all-public-transport-free>

¹⁶<https://www.quora.com/Why-are-people-so-in-love-with-their-cars>



Figure 2.22: Motor traffic in Manila.



Figure 2.23: We love our cars.

“This car is a tribute to my mother, who has passed away a few years ago. I grew up in a 1981 Camaro, she loved her car like I love mine.

“This car goes FAST. I don’t care much for racing but I do love driving fast and boy does her 700rwhp provide that!!

“I have personally seen her at her worst and best. I’ve had my hands covered in Camaro guts, elbow deep. I’ve felt the pain of seeing your brand new car with a blown motor out of it sitting in your garage with a hole where the engine is supposed to be and knowing your warranty ain’t gonna cover that. These experiences made this vehicle mine through blood, sweat, tears, and vulgar language.

“This car is an extension of my personality. I am loud and noisy when I need to be but I prefer to stay subdued. This machine doesn’t need to prove anything. She exudes confidence in herself and her ability to perform at 110% at a moments’ notice - but she don’t need to prove it, you can look at it, you can hear it and you’ll know what’s up. Just like her owner. I have nothing to prove - I’ve made my mark, I believe in myself and let the world make its decision.

“Lastly, this car changed my life. It gave me confidence and pride in myself. It helped me to get in touch with the man I would later grow up to become. It pushed me into a direction in life of working with my hands and being proud of doing well for myself without being stuck in a cubicle. It introduced and brought me into a huge group of amazing people I wouldn’t have otherwise known. It gave my future wife a sense of my personality before she even met me. She knew I was a confident self sufficient red blooded American Male without me even saying a word - my Camaro did all the talking for me. She turns heads, she makes kids jump up and down screaming, ‘THERE’S THE BAT-MOBILE!’ She is a fantastic money sink, a pleasure to drive, and a fine automobile. Never will this vehicle leave my possession and never will it find decay in a junk heap while I walk this earth. It is my friend and compatriot, through thick and thin we have been together, even on the worst days I can hop in this thing and go for a spin and find solace, enjoyment, and testosterone producing speed.”

Investment in electric vehicles

On July 5, 2017, the Volvo Car Group made the following announcement: ¹⁷

“Volvo Cars, the premium car maker, has announced that every Volvo it launches from 2019 will have an electric motor, marking the historic end of cars that only have an internal combustion engine (ICE) and placing electrification at the core of its future business.

“The announcement represents one of the most significant moves by any car maker to embrace electrification and highlights how over a century after the invention of the internal combustion engine electrification is paving the way for a new chapter in automotive history.

“This is about the customer,” said Håkan Samuelsson, president and chief executive.

¹⁷<https://www.media.volvocars.com/global/en-gb/media/pressreleases/210058/volvo-cars-to-go-all-electric>

'People increasingly demand electrified cars and we want to respond to our customers' current and future needs. You can now pick and choose whichever electrified Volvo you wish.'

"Volvo Cars will introduce a portfolio of electrified cars across its model range, embracing fully electric cars, plug in hybrid cars and mild hybrid cars.

"It will launch five fully electric cars between 2019 and 2021, three of which will be Volvo models and two of which will be high performance electrified cars from Polestar, Volvo Cars' performance car arm. Full details of these models will be announced at a later date."

The electric vehicle investment opportunity was also illustrated by the 2017 vote of Germany's Bundesrat to ban the manufacture of internal combustion engines after 2030¹⁸.

The article announcing the vote adds that "It's a strong statement in a nation where the auto industry is one of the largest sectors of the economy; Germany produces more automobiles than any other country in Europe and is the third largest in the world. The resolution passed by the Bundesrat calls on the European Commission (the executive arm of the European Union) to 'evaluate the recent tax and contribution practices of Member States on their effectiveness in promoting zero-emission mobility,' which many are taking to mean an end to the lower levels of tax currently levied on diesel fuel across Europe."

France plans to end the sale of vehicles powered by gasoline and diesel by 2040, environment minister Nicolas Hulot announced recently.

Hulot made the announcement on Thursday, June 13, 2017, in Paris as he launched the country's new Climate Plan to accelerate the transition to clean energy and to meet its targets under the Paris climate agreement.

To ease the transition, Hulot said the French government will offer tax incentives to replace fossil-fuel burning cars with clean alternatives.

Furthermore, the government of India has recently announced its intention to only have electric vehicles by 2030¹⁹. This hugely ambitious plan was announced during the 2017 Confederation of Indian Industry Annual Session. Besides the avoidance of climate change, which might make many regions of India uninhabitable, the motive for replacing 28 million combustion engine vehicles by electric ones was the severe air pollution from which India suffers. Severe air pollution also motivates efforts by the government of China to promote the transition to electric vehicles.

The governments of Norway and the Netherlands have taken steps towards banning the internal combustion engine²⁰. Both the upper and lower houses of the Netherlands' government voted to ban cars driven by internal combustion engines by 2025, the same year in which Norway plans to sell nothing but zero-emission vehicles.

¹⁸<https://arstechnica.com/cars/2016/10/germanys-bundesrat-votes-to-ban-the-internal-combustion-engine-by-2030/>

¹⁹<https://www.greentechmedia.com/articles/read/what-country-will-become-the-first-to-ban-internal-combustion-cars>

²⁰<http://www.prnewswire.com/news-releases/the-dutch-revolution-in-smart-charging-of-electric-vehicles-597268791.html>

In a report commissioned by the investment bankers Cowan & Co, managing director and senior research analyst Jeffrey Osborne, predicted that electric vehicles will cost less than gasoline-powered cars by the early- to mid-2020s due to falling battery prices as well as the costs that traditional carmakers will incur as they comply to new fuel-efficiency standards. Osbourne pointed out that a number of major car brands are hopping onto the electric bandwagon to compete in a space carved out by industry disrupter, Tesla.

“We see the competitive tides shifting in 2019 and beyond as European [car makers] roiled by the diesel scandal and loss of share to Tesla in the high margin luxury segment step on the gas and accelerate the pace of EV introductions”, he wrote.

Bloomberg New Energy Finance reported similar predictions: “Falling battery costs will mean electric vehicles will also be cheaper to buy in the U.S. and Europe as soon as 2025,” the report said. “Batteries currently account for about half the cost of EVs, and their prices will fall by about 77 percent between 2016 and 2030.”

In October, 2017, General Motors unveiled plans to roll out 20 new entirely electric car models by 2023, with two of the new EVs coming out in the next 18 months. Meanwhile, Ford announced the creation of “Team Edison,” intended to accelerate the company’s EV development and partnership work. The name, is “seemingly in direct response to Elon Musk’s Tesla, which recently surpassed Ford’s market capitalization.”

Tesla’s Chairman, highly successful inventor and entrepreneur Elon Musk, has made massive investments in factories manufacturing electric vehicles, improved lithium ion storage cells, and photovoltaic panels, as will be discussed in Chapter 2.

Elon Musk and renewable energy technology

Elon Reve Musk was born in 1971 in South Africa. At the age of 10, he developed an interest in computer programming, and by 12 he had invented a computer game which he sold for \$500. Just before his 18th birthday, Musk moved to Canada, obtaining citizenship through his Canadian-born mother. After studying for two years at Queens University in Kingston Ontario, Musk moved to the University of Pennsylvania, where where he obtained degrees in both science and economics.

At the age of 24, Elon Musk started Ph.D. studies in applied physics and material science at Stanford University, but he left the program (after 2 days!) to pursue his interests in the Internet-based businesses, renewable energy and outer space. He became a US citizen in 2002. In the meantime, Musk’s business ventures and his inventions have made him the 80th wealthiest person in the world. In 2016 he was ranked as 21st on the Forbes list of the world’s most powerful people. He has been called the new Thomas Edison.

Luckily, the transition to 100% renewable energy holds a high place in Musk’s priorities, and he has applied his genius both as an inventor and as a businessman to achieving this goal. Two of the corporations led by Musk, Tesla and Solar City, are devoted to solving the problem of intermittency through improved storage batteries, replacing petroleum-driven automobiles by attractive and affordable electric cars, and harnessing solar energy.

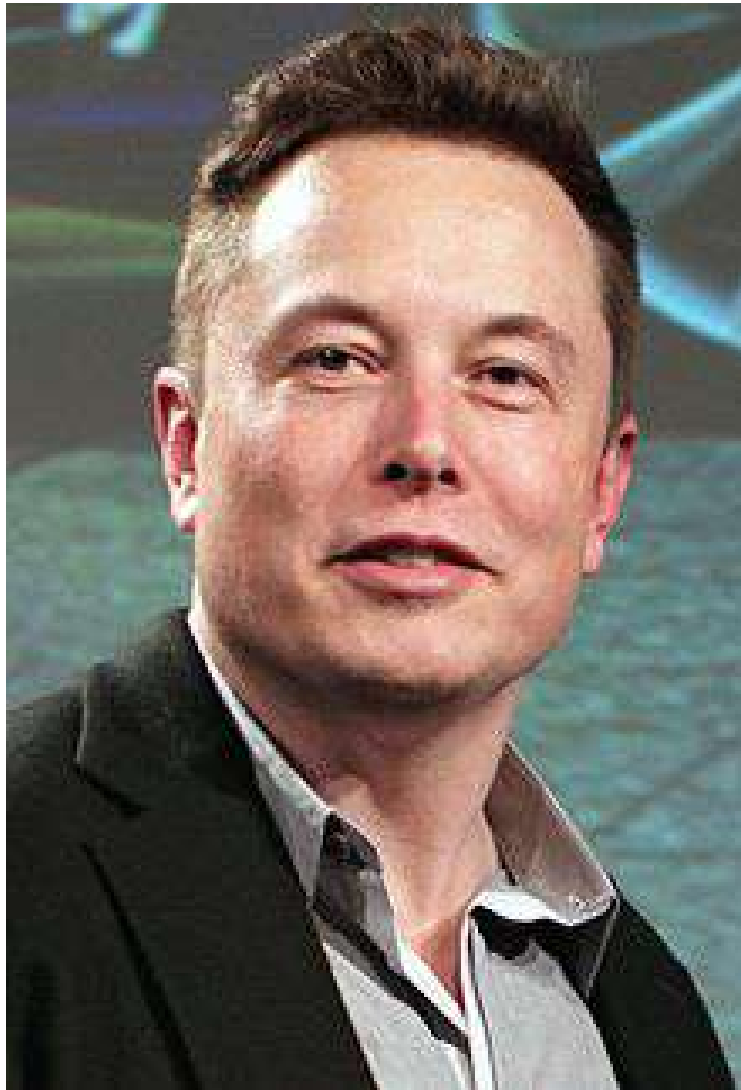

Figure 2.24: **Elon Musk in 2015** (Wikipedia)



Figure 2.25: Tesla's Gigafactory 1 in Nevada produces improved lithium ion batteries. Energy for the factory is supplied by solar panels on the roof.



Figure 2.26: Gigafactory 2. SolarCity's factory in Buffalo New York produces high-efficiency solar modules. Elon Musk estimates that only 100 gigafactories would be enough to achieve a worldwide transition to 100% renewable energy.



Figure 2.27: Tesla was the world's best selling plug-in passenger car manufacturer in 2018.



Figure 2.28: Tesla Model 3 production model.



Figure 2.29: An electric car currently being produced by General Motors.

SolarCity leases rooftop solar to customers who pay no upfront costs. In exchange, customers pay for 20 years for power generated by those panels.

Wikipedia states that “In June 2014, SolarCity announced plans to build a new manufacturing facility in Buffalo, New York, in coordination with the SUNY Polytechnic Institute after acquiring Silevo, a maker of high-efficiency solar modules. The initial manufacturing complex will be a 1.2-million-square-foot (110,000 m²) facility that will cost \$900 million and employ 1,500 workers in Buffalo and 5,000 statewide.”

Speaking at the University of Paris during the recent climate talks, Elon Musk said “The important thing to appreciate is if let’s say the only thing we had was solar energy, that that was the only power source, if you just took a small section of Spain, you could power all of Europe. It’s a very small amount of area that’s actually needed to generate the electricity we need to power civilization, or in the case of the US, a little corner of Nevada or Utah, power the entire United States.”

Musk has also predicted that by 2031, solar energy will be the world’s largest energy source.

2.15 Renewables are now much cheaper than fossil fuels!

According to an article written by Megan Darby and published in *The Guardian* on 26 January, 2016, “Solar power costs are tumbling so fast the technology is likely to fast outstrip mainstream energy forecasts.

“That is the conclusion of Oxford University researchers, based on a new forecasting model published in *Research Policy*²¹.

“Commercial prices have fallen by 58% since 2012 and by 16

“Since the 1980s, panels to generate electricity from sunshine have got 10% cheaper each year. That is likely to continue, the study said, putting solar on course to meet 20% of global energy needs by 2027.’ ’

²¹<http://www.sciencedirect.com/science/article/pii/S0048733315001699>

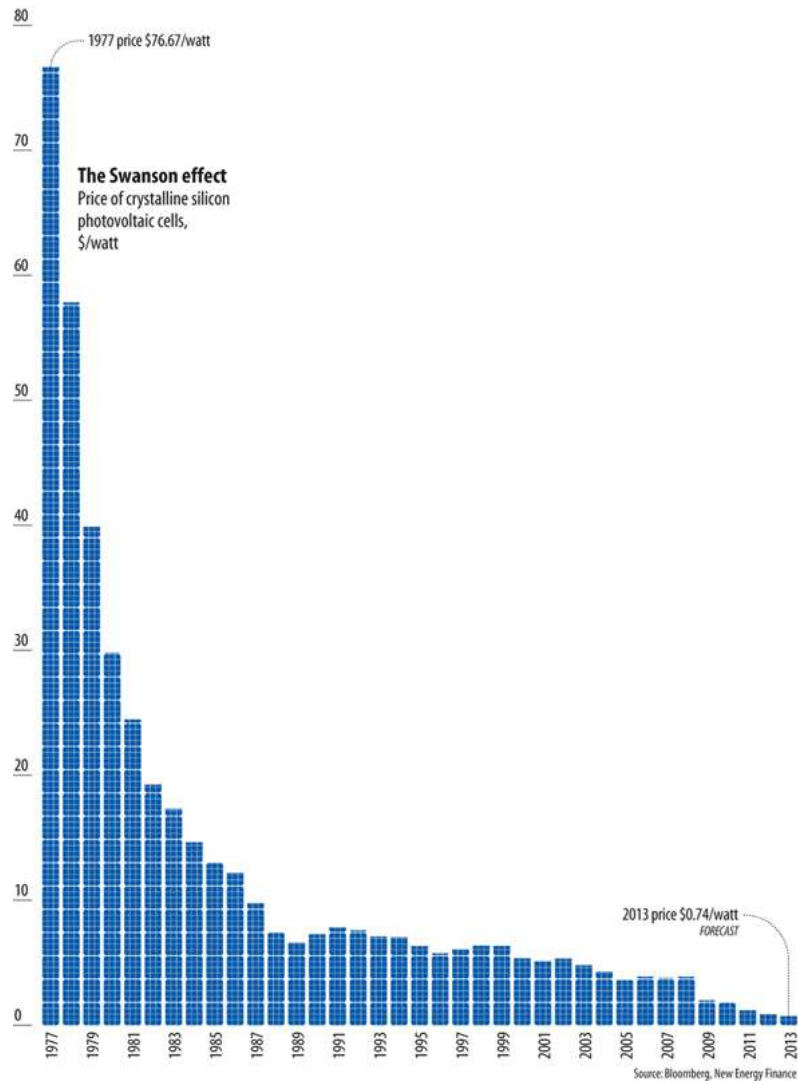

Figure 2.30: The cost of photovoltaic cell panels is falling rapidly

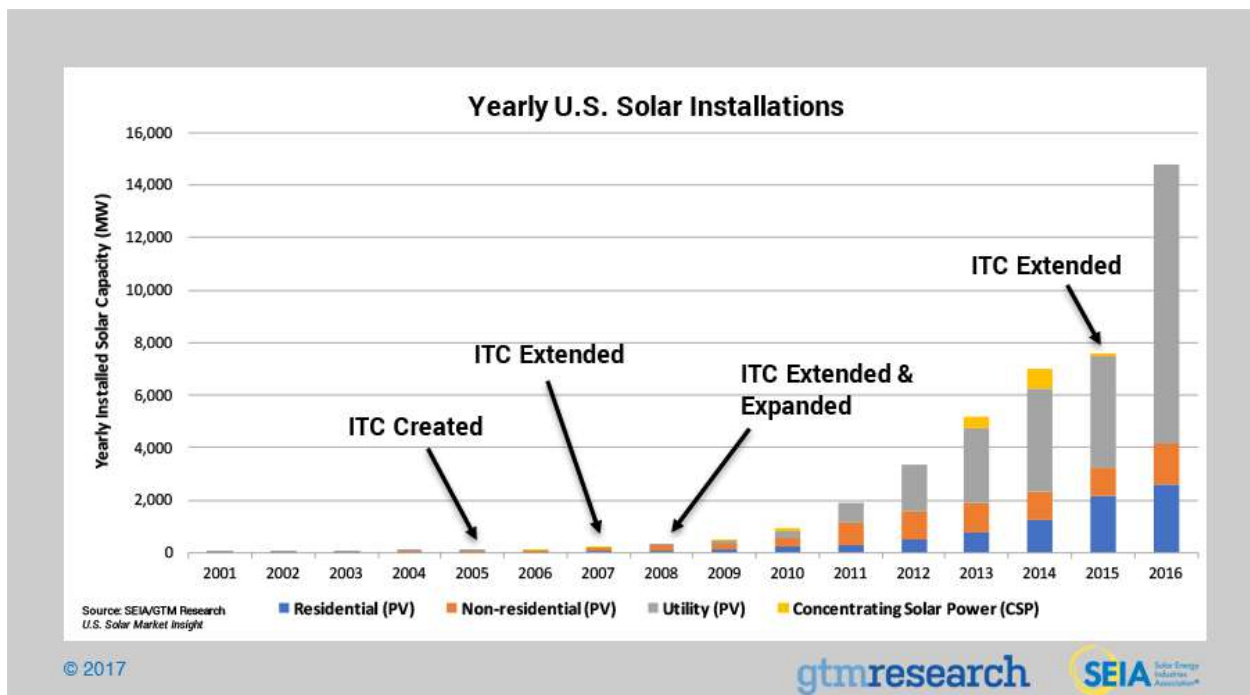

Figure 2.31: Driven by falling prices, new solar installations in the United States are increasing rapidly. The acronym ITC stands for Solar Investment Tax Credit. Commercial prices have fallen by 58% since 2012 and by 16% in the last year

2.16 Lester R. Brown

In December 2008, Lester R. Brown called attention to the following facts:

- The renewable energy industry - wind, solar, geothermal - are expanding by over 30 percent yearly;
- There are now, in the U.S., 24,000 megawatts of wind generating capacity online, but there is a staggering 225,000 megawatts of planned wind farms;
- What is needed is a World War II-type mobilization to produce electric-powered cars that will operate at an equivalent gas cost of \$1 per gallon (Replacing each SUV with a plug-in hybrid could save \$20,000 of oil imports over its lifetime);

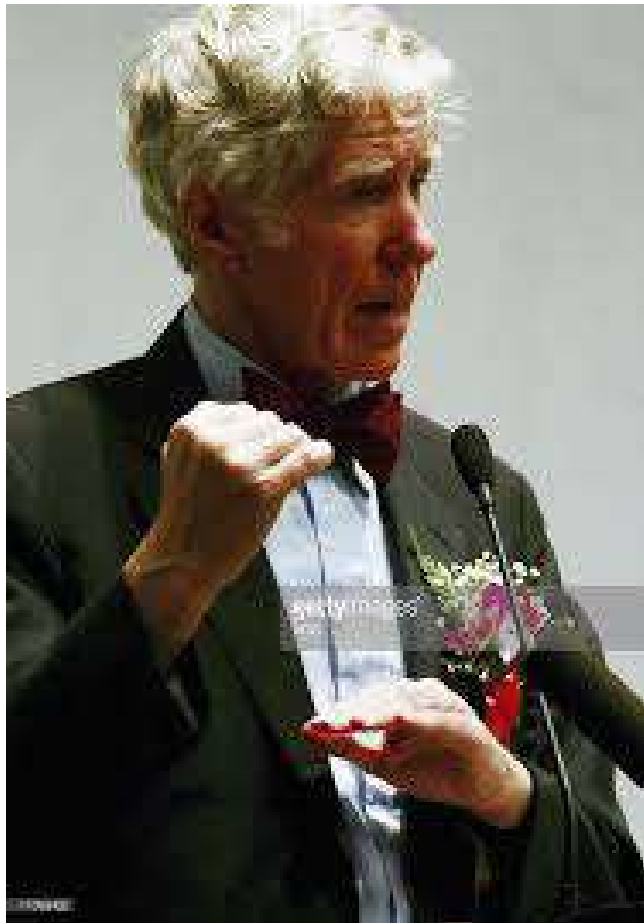

Figure 2.32: Lester R. Brown, born in 1934, is the author of more than 50 books, and he has been called “...one of the world’s most influential thinkers” (Washington Post). He is the founder of the Worldwatch Institute and the Earth Policy Institute. Books produced by Brown and his coworkers at the EPI can be freely downloaded and circulated. The 2015 book *The Great Transition: Shifting From Fossil Fuels to Solar and Wind Energy* can be freely downloaded from the following link: <http://www.earth-policy.org/books/tgt>

2.17 We must create a livable future world

We give our children loving care, but it makes no sense to do so unless we do everything in our power to give them a future world in which they can survive. We also have a duty to our grandchildren, and to all future generations.

The amazingly rapid growth of science, technology, agriculture and industry has given the world many benefits, but indefinite growth on a finite planet is a logical impossibility, and we have now reached the point where the human success story has become a threat. Today we are faced with the threat of an environmental megacatastrophe, of which the danger of catastrophic climate change is a part. Human ingenuity also produced nuclear weapons, but the development of international law, governance and ethics has not kept pace, and we face the threat of an all-destroying nuclear war. Finally, because of population growth, the effect of climate change on agriculture, and the end of the fossil fuel era, there is a danger that by the middle of the present century a very large-scale famine could take the lives of as many as a billion people.

We owe it to future generations to take urgent action to prevent these threatened catastrophes. In the present chapter, we will focus on the climate emergency, while the dangers of nuclear war and famine will be discussed in chapters 3 and 5.

A United Nations report released Wednesday, 20 November, 2019, warned that world-wide projections for fossil fuel production over the next decade indicate that the international community is on track to fail to rein in planet-heating emissions and prevent climate catastrophe.

*The Production Gap*²² is an 80 page report produced by a collaboration between the UN Environmental Programme and a number of academic institutions. It examines the discrepancy between countries' planned fossil fuel production and global production levels consistent with limiting warming to 1.5°C or 2°C, and concludes that the necessary policy changes are currently not being made.

The famous economist Nicholas Stern has stated that “This important report shows that governments' projected and planned levels of coal, oil, and gas production are dangerously out of step with the goals of the Paris agreement on climate change. It illustrates the many ways in which governments subsidize and otherwise support the expansion of such production. Instead, governments should implement policies that ensure existing production peaks soon and then falls very rapidly.”

In an article published in *Common Dreams* on Wednesday, November 20, 2019, Hoda Baraka, the Chief Communications Officer for 350.org wrote: “The disconnect between Paris temperature goals and countries' plans and policies for coal, oil, and gas production is massive, worrying and unacceptable...”

“The *production gap* is a term used to refer to the difference between a countries' planned levels of fossil fuel production, and what is needed to achieve international climate goals. This is the first time a UN report has looked directly and specifically at fossil fuel production as a key driver of climate breakdown. It shows that countries are planning to

²²<http://productiongap.org/wp-content/uploads/2019/11/Production-Gap-Report-2019.pdf>



Figure 2.33: “Ensuring a livable planet for future generations means getting serious about phasing out coal, oil, and gas,” said Christiana Figueres, former executive secretary of the UNFCCC, “Countries such as Costa Rica, Spain, and New Zealand are already showing the way forward, with policies to constrain exploration and extraction and ensure a just transition away from fossil fuels. Others must now follow their lead.”



Figure 2.34: **Today the beautiful city of Venice is flooded. Tomorrow unless urgent climate action is taken, all coastal cities will be under water.**

produce fossil fuels far in excess of the levels needed to fulfil their climate pledges under the Paris Agreement, which themselves are far from adequate. This over investment in coal, oil, and gas supply locks in fossil fuel infrastructure that will make emissions reductions harder to achieve.

“The science is clear, to stay below 1.5 degrees we must stop the expansion of the fossil fuel industry immediately. That means that not a single new mine can be dug, not another pipeline built, not one more emitting powerplant fired up. And we have to get to work transitioning to sustainable renewable energy powered energy systems.

“Across the globe resistance to fossil fuels is rising, the climate strikes have shown the world that we are prepared to take action. Going forward our job is to keep up a steady drumbeat of actions, strikes and protests that gets louder and louder throughout 2020. Governments need to follow through, to act at the source of the flames that are engulfing our planet and phase out coal, oil, and gas production.”



Figure 2.35: On Friday, November 15, 2019, in a speech at the Vatican, Pope Francis railed against corporate crimes and announced consideration of adding “sins against ecology” to the church’s official teachings. “The principle of profit maximization, isolated from any other consideration, leads to a model of exclusion which violently attacks those who now suffer its social and economic costs, while future generations are condemned to pay the environmental costs”, he said. In his speech, Francis condemned global corporations that are responsible for “countries’ over-indebtedness and the plunder of our planet’s natural resources.” He said that their activities have the “gravity of crimes against humanity,” especially when they lead to hunger, poverty and the eradication of indigenous peoples.



Figure 2.36: A new report indicates that half of all insects may have been lost since 1970 as a result of the destruction of nature and heavy use of pesticides. The report said 40% of the 1million known species of insect are facing extinction. Unless steps are taken to correct the excessive use of pesticides and loss of habitat, there will be profound consequences for humans and all life on Earth. “We can’t be sure, but in terms of numbers, we may have lost 50% or more of our insects since 1970 - it could be much more,” said Prof Dave Goulson, at the University of Sussex, UK, who wrote the report for the Wildlife Trusts. Since most crops depend on insect pollination, the insect apocalypse will make it difficult to feed the Earth’s growing population unless urgent corrective steps are taken.



Figure 2.37: Senator Bernie Sanders and Representative Alexandria Ocasio-Cortez field questions from audience members at the Climate Crisis Summit at Drake University on November 9, 2019, in Des Moines, Iowa. “Faced with the global crisis of climate change, the United States must lead the world in transforming our energy system away from fossil fuel to sustainable energy. The Green New Deal is not just about climate change,” Sanders said, “It is an economic plan to create millions of good-paying jobs, strengthen our infrastructure, and invest in our country’s frontline and vulnerable communities.” The Green New Deal, which is strongly advocated by Sanders and Ocasio-Cortez in the United States, and also currently debated in many other countries, is inspired by the set of programs that Franklin D. Roosevelt used to end the Great Depression. It aims at maintaining full employment by substituting jobs in creating renewable energy infrastructure for jobs lost in the fossil fuel sector.



Figure 2.38: The *World Scientists' Warning of a Climate Emergency* was published in *Bioscience* on 5 November, 2019. The article states that “Scientists have a moral obligation to clearly warn humanity of any catastrophic threat and to ‘tell it like it is.’ On the basis of this obligation and the graphical indicators presented below, we declare, with more than 11,000 scientist signatories from around the world, clearly and unequivocally that planet Earth is facing a climate emergency...Despite 40 years of global climate negotiations... we have generally conducted business as usual and have largely failed to address this predicament.”



Figure 2.39: Bush fires in Australia are threatening Sydney and have caused the Australian government to declare a state of emergency. But Australia’s politicians continue the policies that have made their nation a climate change criminal, exporting vast quantities of coal and beef. The Deputy Prime Minister Michael McCormack said, of the fire victims: “They don’t need the ravings of some pure enlightened and woke capital city greenies at this time when they are trying to save their homes.” In other words, let’s not talk about climate change. With costs approaching \$100 billion, and a billion animals killed, the fires are the costliest natural disaster in Australian history. The link to climate change is obvious to anyone not profiting from the export of coal.



Figure 2.40: A Peoples' Climate March in Amsterdam, calling for an ambitious climate policy. The *World Scientists' Warning of a Climate Emergency* called attention to a number of indicators: "The basic scientific data of these changes is presented simply and with great clarity: a 5 percent rise every 10 years in carbon emissions; a 3.65 percent rise of another powerful greenhouse gas, methane, every 10 years; a global surface temperature rise of .183 degrees Celsius every 10 years; a decline of Arctic sea ice at a rate of 11.7 percent every 10 years; significant drops in the ice mass of Greenland, Antarctica and world glaciers; an increase in ocean acidity and temperatures; an increase of 44 percent in the amount of area burned by wildfires in the U.S. every 10 years; and an 88 percent rise in extreme weather events per 10 years."

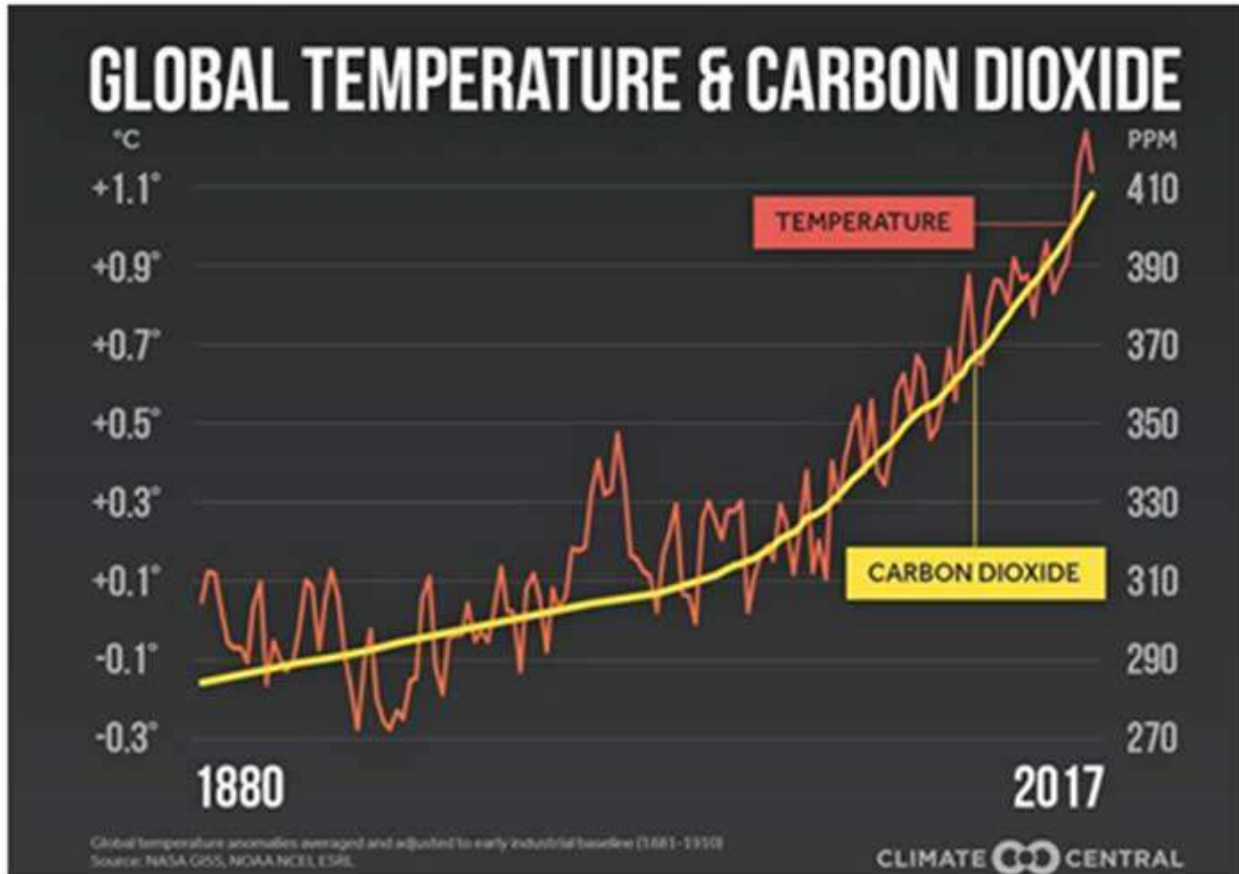

Figure 2.41: The graphs showing increase in global temperatures and carbon dioxide follow each other closely. In an article published in *Countercurrents* on November 6, 2019, Dr. Andrew Glickson wrote: “As the concentration of atmospheric CO₂ has risen to 408 ppm and the total greenhouse gas level, including methane and nitrous oxide, combine to near 500 parts per million CO₂-equivalent, the stability threshold of the Greenland and Antarctic ice sheets, currently melting at an accelerated rate, has been exceeded. The consequent expansion of tropics and the shift of climate zones toward the shrinking poles lead to increasingly warm and dry conditions under which fire storms, currently engulfing large parts of South America, California, Alaska, Siberia, Sweden, Spain, Portugal, Greece, Angola, Australia and elsewhere have become a dominant factor in the destruction of terrestrial habitats.”



Figure 2.42: The Royal Society of the United Kingdom documented ExxonMobil's funding of 39 organizations that promoted "inaccurate and misleading" views of climate science. In an article published by TomDispatch on November 11, 2019, Professor Naomi Oreskes of Harvard University wrote: "Much focus has been put on ExxonMobil's history of disseminating disinformation, partly because of the documented discrepancies between what that company said in public about climate change and what its officials said (and funded) in private. Recently, a trial began in New York City accusing the company of misleading its investors, while Massachusetts is prosecuting ExxonMobil for misleading consumers as well. If only it had just been that one company, but for more than 30 years, the fossil-fuel industry and its allies have denied the truth about anthropogenic global warming. They have systematically misled the American people and so purposely contributed to endless delays in dealing with the issue by, among other things, discounting and disparaging climate science, misrepresenting scientific findings, and attempting to discredit climate scientists. These activities are documented in great detail in *How Americans Were Deliberately Misled about Climate Change*, a report I recently co-authored, as well as in my 2010 book and 2014 film, *Merchants of Doubt*."



Figure 2.43: A fire burns a tract of the Amazon jungle in Agua Boa, Mato Grosso state, Brazil September 4, 2019. According to a report published by teleSUR on 7 November, 2019, “Deforestation in Brazil’s Amazon region increased by 80 percent in September compared to the same month last year, according to a private study released on Wednesday stating that 802 square kilometers of forest was lost in the zone... Environmental and human rights organizations have confirmed that criminal networks are behind the indiscriminate cutting of trees in the region, and that after the illegal lumbering, those deforested zones are burned to make the land suitable for livestock raising and agriculture. In August, fires in the Brazilian Amazon were the worst in a decade, a situation that was denounced worldwide, especially the anti-ecological policies of President Jair Bolsonaro and his poor response to stop the fires.”



Figure 2.44: In her testimony to the US Congress, Greta Thunberg did not prepare a statement for submission to the record. Instead, she submitted the most recent scientific report, issued by the IPCC three weeks earlier. She said simply, “I am submitting this report as my testimony because I don’t want you to listen to me, I want you to listen to the scientists, and I want you to unite behind the science. And then I want you to take real action. Thank you.” Here is what the scientists recommend: “Excessive extraction of materials and overexploitation of ecosystems, driven by economic growth, must be quickly curtailed to maintain the long-term sustainability of the biosphere. We need a carbon-free economy that explicitly addresses human dependence on the biosphere and policies that guide economic decisions accordingly. Our goals need to shift from GDP growth and the pursuit of affluence toward sustaining ecosystems and improving human well-being by prioritizing basic needs and reducing inequality.”



Figure 2.45: Climate activist Greta Thunberg joined thousands of protesters in Lausanne, Switzerland Jan. 17, 2020. The youth activists were planning to attend the Davos summit to demand that “participants from all companies, banks, institutions, and governments immediately halt all investments in fossil fuel exploration and extraction, immediately end all fossil fuel subsidies, and immediately and completely divest from fossil fuels.”

2.18 The Evangelicals believe that there is no need to act

Here is an excerpt frp, an article by Bernard Daley Zaleha and Andrew Szasz entitled *Why conservative Christians don't believe in climate change*²³:

American Christians have become increasingly polarized on issues of climate change and environmental regulation. In recent years, mainline Protestant denominations and the Roman Catholic Church have made explicit declarations of support for global climate action. Prominent Southern Baptists and other evangelical Protestants, on the other hand, have issued statements that are strikingly similar to the talking points of secular climate skeptics, and have attempted to stamp out “green” efforts within their own ranks. An analysis of resolutions and campaigns by evangelicals over the past 40 years shows that anti-environmentalism within conservative Christianity stems from fears that “stewardship” of God’s creation is drifting toward neo-pagan nature worship, and from apocalyptic beliefs about “end times” that make it pointless to worry about global warming. As the climate crisis deepens, the moral authority of Christian leaders and organizations may play a decisive role in swaying public policy toward (or away from) action to mitigate global warming.

The highly dangerous beliefs of the Evangelicals are in strong contrast to the courageous and enlightened leadership of Pope Francis, who urges us to act resolutely to prevent catastrophic climate change.

2.19 Banks give fossil fuel giants \$1.9 trillion since Paris

Banking on Climate Change 2019 - Fossil Fuel Report Card / : Alison Kirsch et al Rainforest Action Network (RAN) et al.. For the first time, this report adds up lending and underwriting from 33 global banks to the fossil fuel industry as a whole. The findings are stark: these Canadian, Chinese, European, Japanese, and U.S. banks have financed fossil fuels with \$1.9 trillion since the Paris Agreement was adopted (2016-2018), with financing on the rise each year. This report finds that fossil fuel financing is dominated by the big U.S. banks, with JPMorgan Chase as the world’s top funder of fossil fuels by a wide margin. In other regions, the top bankers of fossil fuels are Royal Bank of Canada in Canada, Barclays in Europe, MUFG in Japan, and Bank of China in China. Here are some quotations from the report:

²³Bulletin of the Atomic Scientists 2015, Vol. 71(5) 19-30

In October 2018, the Intergovernmental Panel on Climate Change (IPCC) released a sobering report on the devastating impacts our world will face with 1.5° Celsius of warming - let alone 2°C - while setting out the emissions trajectory the nations of the world need to take if we are to have any shot at keeping to that 1.5°C limit. This 10th edition of the annual fossil fuel finance report card, greatly expanded in scope, reveals the paths banks have taken in the past three years since the Paris Agreement was adopted, and finds that overall bank financing continues to be aligned with climate disaster.

For the first time, this report adds up lending and underwriting from 33 global banks to the fossil fuel industry as a whole. The findings are stark: these Canadian, Chinese, European, Japanese, and U.S. banks have financed fossil fuels with \$1.9 trillion since the Paris Agreement was adopted (2016-2018), with financing on the rise each year. This report finds that fossil fuel financing is dominated by the big U.S. banks, with JPMorgan Chase as the world's top funder of fossil fuels by a wide margin. In other regions, the top bankers of fossil fuels are Royal Bank of Canada in Canada, Barclays in Europe, MUFG in Japan, and Bank of China in China.

This report also puts increased scrutiny on the banks' support for 100 top companies that are expanding fossil fuels, given that there is no room for new fossil fuels in the world's carbon budget. And yet banks supported these companies with \$600 billion in the last three years. JPMorgan Chase is again on top, by an even wider margin, and North American banks emerge as the biggest bankers of expansion as well.

This report also grades banks' overall future-facing policies regarding fossil fuels, assessing them on restrictions on financing for fossil fuel expansion and commitments to phase out fossil fuel financing on a 1.5°C-aligned trajectory. While some banks have taken important steps, overall major global banks have simply failed to set trajectories adequate for dealing with the climate crisis.

As in past editions, this fossil fuel finance report card also assesses bank policy and practice around financing in certain key fossil fuel subsectors, with league tables and policy grades on:

- **Tar sands oil:** RBC, TD, and JPMorgan Chase are the biggest bankers of 30 top tar sands producers, plus four key tar sands pipeline companies. In particular, these banks and their peers support companies working to expand tar sands infrastructure, such as Enbridge and Teck Resources.
- **Arctic oil and gas:** JPMorgan Chase is the world's biggest banker of Arctic oil and gas by far, followed by Deutsche Bank and SMBC Group. Worryingly, financing for this subsector increased from 2017 to 2018.
- **Ultra-deepwater oil and gas:** JPMorgan Chase, Citi, and Bank of America are the top bankers here. Meanwhile, none of the 33 banks have policies to proactively restrict financing for ultra-deepwater extraction.





- **Fracked oil and gas:** For the first time, the report card looks at bank support for top fracked oil and gas producers and transporters - and finds financing is on the rise over the past three years. Wells Fargo and JPMorgan Chase are the biggest bankers of fracking overall - and, in particular, they support key companies active in the Permian Basin, the epicenter of the climate-threatening global surge of oil and gas production.
- **Liquefied natural gas (LNG):** Banks have financed top companies building LNG import and export terminals around the world with \$46 billion since the Paris Agreement, led by JPMorgan Chase, Société Générale, and SMBC Group. Banks have an opportunity to avoid further damage by not financing Anadarko's Mozambique LNG project, in particular.
- **Coal mining:** Coal mining finance is dominated by the four major Chinese banks, led by China Construction Bank and Bank of China. Though many European and U.S. banks have policies in place restricting financing for coal mining, total financing has only fallen by three to five percentage points each year.
- **Coal power:** Coal power financing is also led by the Chinese banks - Bank of China and ICBC in particular - with Citi and MUFG as the top non-Chinese bankers of coal power. Policy grades for this subsector show some positive examples of European banks restricting financing for coal power companies.

The human rights chapter of this report shows that as fossil fuel companies are increasingly held accountable for their contributions to climate change, finance for these companies also poses a growing liability risk for banks. The fossil fuel industry has been repeatedly linked to human rights abuses, including violations of the rights of Indigenous peoples and at-risk communities, and continues to face an ever-growing onslaught of lawsuits, resistance, delays, and political uncertainty.

The IPCC's 2018 report on the impacts of a 1.5°C increase in global temperature showed clearly the direction the nations of the world need to take, and the emissions trajectory we need to get there. Banks must align with that trajectory by ending financing for expansion, as well as for these particular spotlight fossil fuels - while committing overall to phase out all financing for fossil fuels on a Paris Agreement-compliant timeline.



Figure 2.46: Drilling for oil in the Arctic.



Figure 2.47: Indigenous protests against Arctic drilling.





Figure 2.48: A coal-fired power plant.

2.20 Fossil fuel industry's disinformation campaign

The Wikipedia article on climate change denial describes it with the following words: “Although scientific opinion on climate change is that human activity is extremely likely to be the primary driver of climate change, the politics of global warming have been affected by climate change denial, hindering efforts to prevent climate change and adapt to the warming climate. Those promoting denial commonly use rhetorical tactics to give the appearance of a scientific controversy where there is none.”

It is not surprising that the fossil fuel industry supports, on a vast scale, politicians and mass media that deny the reality of climate change. The amounts of money at stake are vast. If catastrophic climate change is to be avoided, coal, oil and natural gas “assets” worth trillions of dollars must be left in the ground. Giant fossil fuel corporations are desperately attempting to turn these “assets” into cash.

According to a recent article published in “The Daily Kos”²⁴, companies like Shell and Exxon, knew, as early as the 1970s, how their combustible products were contributing to irreversible warming of the planet, became public knowledge over the last few years.

A series of painstakingly researched articles²⁵ published in 2015 by the Pulitzer-prize winning Inside Climate News revealed an industry totally aware and informed for decades about the inevitable warming certain to occur as more and more carbon dioxide from the burning of fossil fuels was released into the atmosphere.

The article states that “In fact, the oil industry, and Exxon in particular, had the best climate models available, superior to those relied on by scientific community.²⁶ And armed with the foreknowledge developed through those models, Exxon and the other oil companies planned and executed an elaborate, cynical long term strategy: to invest hundreds of millions of dollars in a comprehensive propaganda effort designed to raise doubts about the existence and cause of climate change, a phenomenon they well knew was irrefutable, based on their own research. By 2016 the industry’s lobbying to discredit the science of climate change had surpassed two billion dollars.

“Meanwhile, as newly discovered documents reported in The Guardian²⁷ attest, the same companies were preparing projections of what type of world they would be leaving for the rest of humanity. In the 1980s, oil companies like Exxon and Shell carried out internal assessments of the carbon dioxide released by fossil fuels, and forecast the planetary consequences of these emissions. In 1982, for example, Exxon predicted that by about 2060, CO₂ levels would reach around 560 parts per million - double the preindustrial level - and that this would push the planet’s average temperatures up by about 2°C over then-current

²⁴www.dailykos.com/stories/2018/9/23/1797888/-The-Oil-Companies-not-only-knew-fossil-fuels-caused-climate-change-they-knew-how-bad-it-would-get?detail=emaildkre

²⁵<https://insideclimatenews.org/news/15092015/Exxons-own-research-confirmed-fossil-fuels-role-in-global-warming>

²⁶<https://insideclimatenews.org/news/18092015/exxon-confirmed-global-warming-consensus-in-1982-with-in-house-climate-models>

²⁷<https://www.theguardian.com/environment/climate-consensus-97-per-cent/2018/sep/19/shell-and-exxons-secret-1980s-climate-change-warnings>

levels (and even more compared to pre-industrial levels).”²⁸

The Fossil Free MIT report, 2014

Here are some excerpts from a report entitled “**The Fossil Fuel Industry’s Role in Hindering Climate Change Action: Lobbying and Disinformation Against Science and Scientists**”²⁹:

In response to the unprecedented urgency of global climate change, Fossil Free MIT’s petition, signed by more than 2,400 MIT members, is calling on MIT to divest its \$11 billion endowment from the 200 fossil fuel companies with the world’s largest publicly traded carbon reserves.

Fossil Free MIT believes that divestment from the fossil fuel industry presents MIT with a unique opportunity to lead the global effort to combat climate change. We wholeheartedly support our Institute’s cutting-edge climate science and renewable energy technology research, as well as MIT’s campus sustainability initiatives, and we propose divestment as a highly complementary strategy that will bring MIT’s investments in line with the goals of its research and sustainability activities. There are three central reasons why we urge MIT to divest from the fossil fuel industry:

- The fossil fuel industry’s business practice is fundamentally inconsistent with the science of climate change mitigation. A 66% chance of limiting global warming to less than 2°C above pre-industrial temperatures demands that no more than 35% of proven fossil fuel reserves can be burned prior to 2100. Yet in 2012, the fossil fuel industry spent \$674 billion developing new reserves.
- The fossil fuel industry spends hundreds of millions of dollars lobbying and donating in Washington, D.C. against legislation for climate change action.
- Many fossil fuel companies are responsible for funding or orchestrating targeted anti-science disinformation campaigns that confuse the public,

²⁸See also <https://truthout.org/articles/self-immolation-as-the-world-burns-an-earth-day-report/>
<https://countercurrents.org/2018/04/29/the-methane-time-bomb-and-the-future-of-the-biosphere/>
<https://countercurrents.org/2018/08/07/hothouse-earth-evidence-for-ademise-of-the-planetary-life-support-system/>
<https://www.independent.co.uk/environment/global-warming-temperature-rise-climate-change-end-century-science-a8095591.html>
<http://www.lifeworth.com/deepadaptation.pdf>
<https://www.independent.co.uk/news/business/news/bp-shell-oil-global-warming-5-degree-paris-climate-agreement-fossil-fuels-temperature-rise-a8022511.html>

²⁹<https://www.fossilfreemit.org/wp-content/uploads/2014/08/FossilFreeMIT-Lobbying-Disinformation.pdf>

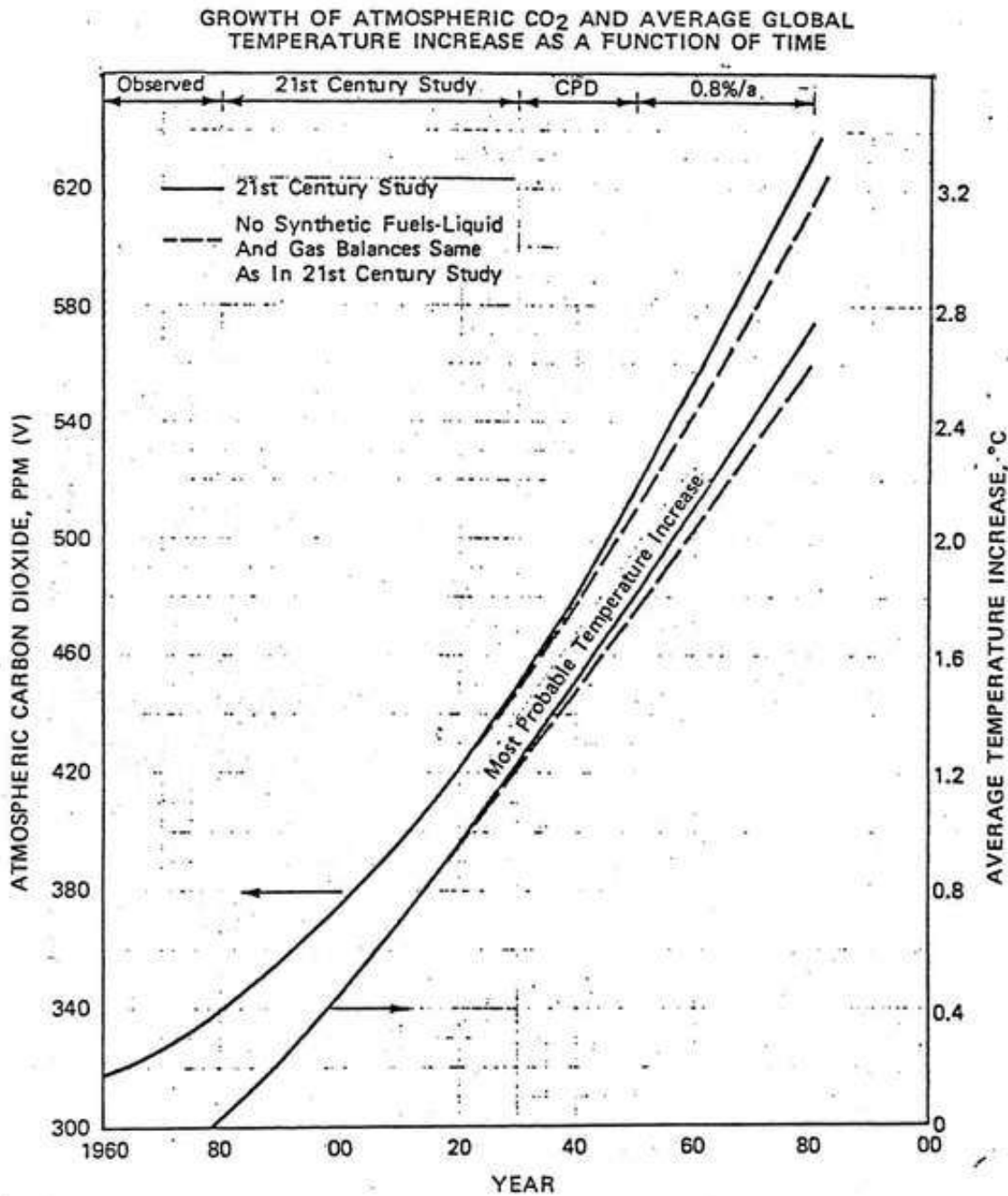

Figure 2.49: Exxon's 1982 internal projections of the future increase in carbon dioxide levels shows CO₂ percentages increasing to 600 ppm and temperature increases of up to 3°C.

sabotage science, and slander scientists.

Disinformation from fossil fuel and tobacco industries

Here are some excerpts from a February 19 2019 article by Mat Hope entitled “**Revealed: How the Tobacco and Fossil Fuel Industries Fund Disinformation Campaigns Around the World**”³⁰:

Fossil fuel companies have a long history of adopting public relations strategies straight from the tobacco industry’s playbook. But a new analysis shows the two industries’ relationship goes much deeper - right down to funding the same organizations to do their dirty work.

MIT Associate Professor David Hsu analyzed organizations in DeSmog’s disinformation database and the Guardian’s tobacco database and found 35 thinktanks based in the US, UK, Australia, and New Zealand that promote both the tobacco and fossil fuel industries’ interests.

Of these organizations, DeSmog can reveal that 32 have taken direct donations from the tobacco industry, 29 have taken donations from the fossil fuel industry, and 28 have received money from both. Two key networks, based around the Koch brothers and Atlas Network, are involved in coordinating or funding many of the thinktanks.

³⁰<https://www.desmogblog.com/2019/02/19/how-tobacco-and-fossil-fuel-companies-fund-disinformation-campaigns-around-world>



Figure 2.50: Smoke destroys human health, regardless of whether it is from cigarettes or coal-fired power plants. Fossil fuel corporations and tobacco companies have exhibited an astonishing degree of cynicism and lack of social responsibility.

Suggestions for further reading

1. G. Boyle (editor), *Renewable Energy: Power for a Sustainable Future, Second Edition*, Oxford University Press, (2004).
2. G. Boyle, B. Everett and J. Ramage (editors), *Energy Systems and Sustainability*, Oxford University Press, (2003).
3. United Nations Development Programme, *World Energy Assessment*, United Nations, New York, (2002).
4. P. Smith et al., *Meeting Europe's Climate Change Commitments: Quantitative Estimates of the Potential for Carbon Mitigation by Agriculture*, *Global Change Biology*, **6**, 525-39, (2000).
5. R.E.H. Sims, *The Brilliance of Energy: In Business and in Practice*, James and James, London, (2002).
6. Friends of the Earth, *Energy Without End*, FOE, London, (1991).
7. E.A. Alma and E. Neala, *Energy Viability of Photovoltaic Systems*, *Energy Policy*, **28**, 999-1010, (2000).
8. Department of Trade and Industry, *Developments of Solar Photovoltaics in Japan*, *Global Watch Mission Report*, November, (2003).
9. European Photovoltaics Industry Association, *Solar Generation: Solar Electricity for Over 1 Billion People and 2 Million Jobs by 2020*, EPA, published in association with Greenpeace (see www.cleanenergynow.org), (2001).
10. B. Sørensen, *Renewable Energy, Second Edition*, Academic Press, (2000).

11. K. Illum, *A Viable Energy Strategy for the Nordic Countries*, Greenpeace Nordic, (2006).
12. K. Illum, *SESAME: The Sustainable Energy Systems Analysis Model*, Almqvist University Press, Denmark, (1995).
13. G. Sinden, *Wind Power and the UK Wind Resource*, Environmental Change Institute, University of Oxford, (2005).
14. P. Börjesson, *Energy Analysis of Biomass Production and Transportation*, Biomass and Energy, **11**, 305-318, (1996).
15. P. Börjesson, *Emissions of CO₂ from Biomass Production and Transportation*, Energy Conversion Management, **37**, 1235-1240, (1995).
16. P. Börjesson and L. Gustav's, *Regional Production and Utilization of Biomass in Sweden*, Energy - The International Journal, **21**, 747-764, (1996).
17. D. Duodena and C. Galvin, *Renewable Energy*, W.W. Norton, New York, (1983).
18. G. Foley, *The Energy Question*, Penguin Books Ltd., (1976).
19. D. Hayes, *The Solar Energy Timetable*, Worldwatch Paper 19, Worldwatch Institute, Washington D.C., (1978).
20. J. Holdren and P. Herrera, *Energy*, Sierra Club Books, New York, (1971).
21. L. Rosen and R. Glasser (eds.), *Climate Change and Energy Policy*, Los Alamos National Laboratory, AIP, New York, (1992).
22. A.B. Lovins, *Soft Energy Paths*, Ballinger, Cambridge, (1977).
23. National Academy of Sciences, *Energy and Climate*, NAS, Washington D.C., (1977).
24. LTI-Research Group, ed., *Long-Term Integration of Renewable Energy Sources into the European Energy System*, Physica Verlag, (1998).
25. P.H. Ableson, *Renewable Liquid Fuels*, Science, **268**, 5213, (1995).
26. W.H. Avery and C. Wu, *Renewable Energy From the Ocean. A Guide to OTEC*, Oxford University Press, (1994).
27. H.M. Brownstein et al., *Biomass Energy Systems and the Environment*, Pergamon Press, New York, (1981).
28. M. Brower, *Cool Energy. Renewable Solutions to Environmental Problems*, MIT Press, Cambridge, Massachusetts, (1994).
29. L.R. Brown, *Food or Fuel: New Competition for the World's Cropland*, Worldwatch Paper 35, Worldwatch Institute, Washington D.C., (1980).
30. C.H. Deutsch, *As Oil Prices Rise, the Hydrogen Car is Looking Better*, New York Times, August 26, (1990).
31. W.L. Driscoll, *Fill 'Er Up with Biomass Derivatives*, Technology Review, August/September, 74-76, (1993).
32. J. Dunkerley et al., *Energy Strategies for Developing Nations*, Resources for the Future, Washington D.C., (1981).
33. C. Flavin and N. Lenssen, *Beyond the Petroleum Age: Designing a Solar Economy*, Worldwatch Paper 100, Worldwatch Institute, Washington D.C., (1990).
34. C. Flavin and N. Lenssen, *The Power Surge. Guide to the Coming Energy Revolution*, W.W. Norton, New York, (1994).

35. J. Gever et al., *Beyond Oil. The Threat to Food and Fuel in the Coming Decades*, Ballinger, Cambridge Massachusetts, (1986).
36. E.A. Hiller and B.A. Stout, *Biomass Energy. A Monograph*, Texas A&M University Press, College Station, Texas, (1985).
37. T.B. Johansson et al., (editors), *Renewable Energy: Sources for Fuels and Electricity*, Island Press, Washington D.C., (1982).
38. D. Knott, *Hydrogen: The Fuel of the Future?*, Oil and Gas Journal, May, 26, (1994).
39. D.K. McDaniels, *The Sun: Our Future Energy Source* Second Edition, Krieger, Malabar Florida, (1994).
40. D. Pimentel, *Renewable Energy: Economic and Environmental Issues*, BioScience, **44**, 536-547, (1994).
41. D. Ross, *Power From the Waves*, Oxford University Press, (1995).
42. S. Sanchez, *Movement is in the Air As Texas Taps the Wind*, USA Today, November, (1995).
43. C.C. Swan, *Suncell. Energy, Economics and Photovoltaics*, Sierra Club Books, San Francisco, (1986).
44. I. Wickelgren, *Sunup at Last for Solar?*, Business Week, July 24, 84,86, (1995).
45. K. Zweibel, *Thin-film Photovoltaic Cells*, American Scientist, **81**, 362-369, (1993).
46. R. Golob and E. Brus, *The Almanac of Renewable Energy. The Complete Guide to Emerging Energy Technologies*, Henry Holt and Company, New York, (1993).
47. N. Yoneda and S. Ito, *Study of Energy Storage for Long Term Using Chemical Reactions*, 3rd International Solar Forum, Hamburg, Germany, June 24-27, (1980).
48. R. Curtis, *Earth Energy in the UK*, in *Proc. International Geothermal Days 'Germany 2001', conference*, Bad Urach, Available in PDF format on www.uni-giessen.de, (2001).
49. R. Harrison, N.D. Mortimer and O.B. Smarason, *Geothermal Heating: A Handbook of Engineering Economics*, Pergamon Press, (1990).
50. G.W. Hutterer, *The Status of World Geothermal Power Generation 1995-2000*, in **WGC 2000**, (2000).
51. International Geothermal Association, *Performance Indicators for Geothermal Power Plant*, IGA News, **45**, July-September, (2001).
52. J.W. Lund and D.H. Freestone, *Worldwide Direct Use of Geothermal Energy 2000*, in **WGC 2000**, (2000).
53. H.C.H. Armstead and J.W. Tester, *Heat Mining*, Chapman and Hall, (1987).
54. T.B. Johansson et al. (editors), *Electricity - Efficient End Use*, Lund University Press, (1989).
55. S. Krohn, *Wind Energy Policy in Denmark, Status 2002*, Danish Windpower Association, (2002), www.windpower.dk.
56. Imperial College London, *Assessment of Technological Options to Address Climate Change*, ICCEPT, (www.iccept.ic.ac.uk), (2002).
57. J. Guldemberg, (editor), *World Energy Assessment: Energy and the Challenge of Sustainability*, United Nations Development Programme, New York, (2000).

58. European Commission, *Green Paper - Towards a European Strategy for the Security of Energy Supply*, COM(2000) final, (2000).
59. P. Dal and H.S. Jensen, *Energy Efficiency in Denmark*, Danish Energy Ministry, (2000).
60. A.C. Baker, *Tidal Power*, *Energy Policy*, **19**, 792-7, (1991).
61. Department of Energy, *Tidal Power from the Severn Estuary, Volume I*, Energy Paper 46 (The Bondi Report), HMSO, (1987).
62. House of Commons Select Committee on Energy, *Renewable Energy*, Fourth Report Session 1991-1992, HMSO, (1992).
63. American Wind Energy Association, *Global Wind Energy Market Report*, AWEA, (2003).
64. M. Andersen, *Current Status of Wind Farms in the UK*, Renewable Energy Systems, (1992).
65. Border Wind, *Offshore Wind Energy: Building a New Industry for Britain*, Greenpeace, (1998).
66. J. Beurkens and P.H. Jensen, *Economics of Wind Energy, Prospects and Directions*, Renewable Energy World, July-Aug, (2001).
67. British Wind Energy Association, *Best Practice Guidelines for Wind Energy Development*, BWEA, (1994).
68. British Wind Energy Association, *Planning Progress*, BWEA, (2003) (www.britishwindenergy.co.uk)
69. Department of Trade and Industry, *Future Offshore: A Strategic Framework for the Offshore Wind Industry*, DTI, November (2002).
70. European Wind Energy Association, *Time for Action: Wind Energy in Europe*, EWEA, (1991).
71. European Wind Energy Association, *Wind Force 12*, EWEA, (2002).
72. T. Burton et al., *Wind Energy Handbook*, Wiley, (2001).
73. J.F. Manwell et al., *Wind Energy Explained*, Wiley, (2002).
74. G. Boyle (editor), *Renewable Energy: Power for a Sustainable Future, Second Edition*, Oxford University Press, (2004).
75. G. Boyle, B. Everett and J. Ramage (editors), *Energy Systems and Sustainability*, Oxford University Press, (2003).
76. United Nations Development Programme, *World Energy Assessment*, United Nations, New York, (2002).
77. P. Smith et al., *Meeting Europe's Climate Change Commitments: Quantitative Estimates of the Potential for Carbon Mitigation by Agriculture*, *Global Change Biology*, **6**, 525-39, (2000).
78. R.E.H. Sims, *The Brilliance of Energy: In Business and in Practice*, James and James, London, (2002).
79. Friends of the Earth, *Energy Without End*, FOE, London, (1991).
80. E.A. Alma and E. Neala, *Energy Viability of Photovoltaic Systems*, *Energy Policy*, **28**, 999-1010, (2000).
81. Department of Trade and Industry, *Developments of Solar Photovoltaics in Japan*, Global Watch Mission Report, November, (2003).

82. B. Sørensen, *Renewable Energy, Second Edition*, Academic Press, (2000).
83. K. Illum, *A Viable Energy Strategy for the Nordic Countries*, Greenpeace Nordic, (2006).
84. K. Illum, *SESAME: The Sustainable Energy Systems Analysis Model*, Almqvist University Press, Denmark, (1995).
85. G. Sinden, *Wind Power and the UK Wind Resource*, Environmental Change Institute, University of Oxford, (2005).
86. P. Börjesson, *Energy Analysis of Biomass Production and Transportation*, Biomass and Energy, **11**, 305-318, (1996).
87. P. Börjesson, *Emissions of CO₂ from Biomass Production and Transportation*, Energy Conversion Management, **37**, 1235-1240, (1995).
88. P. Börjesson and L. Gustav's, *Regional Production and Utilization of Biomass in Sweden*, Energy - The International Journal, **21**, 747-764, (1996).
89. D. Duodena and C. Galvin, *Renewable Energy*, W.W. Norton, New York, (1983).
90. G. Foley, *The Energy Question*, Penguin Books Ltd., (1976).
91. D. Hayes, *The Solar Energy Timetable*, Worldwatch Paper 19, Worldwatch Institute, Washington D.C., (1978).
92. J. Holdren and P. Herrera, *Energy*, Sierra Club Books, New York, (1971).
93. L. Rosen and R. Glasser (eds.), *Climate Change and Energy Policy*, Los Alamos National Laboratory, AIP, New York, (1992).
94. A.B. Lovins, *Soft Energy Paths*, Ballinger, Cambridge, (1977).
95. National Academy of Sciences, *Energy and Climate*, NAS, Washington D.C., (1977).
96. LTI-Research Group, ed., *Long-Term Integration of Renewable Energy Sources into the European Energy System*, Physica Verlag, (1998).
97. P.H. Ableson, *Renewable Liquid Fuels*, Science, **268**, 5213, (1995).
98. W.H. Avery and C. Wu, *Renewable Energy From the Ocean. A Guide to OTEC*, Oxford University Press, (1994).
99. H.M. Brownstein et al., *Biomass Energy Systems and the Environment*, Pergamon Press, New York, (1981).
100. M. Brower, *Cool Energy. Renewable Solutions to Environmental Problems*, MIT Press, Cambridge, Massachusetts, (1994).
101. L.R. Brown, *Food or Fuel: New Competition for the World's Cropland*, Worldwatch Paper 35, Worldwatch Institute, Washington D.C., (1980).
102. C.H. Deutsch, *As Oil Prices Rise, the Hydrogen Car is Looking Better*, New York Times, August 26, (1990).
103. W.L. Driscoll, *Fill 'Er Up with Biomass Derivatives*, Technology Review, August/September, 74-76, (1993).
104. J. Dunkerley et al., *Energy Strategies for Developing Nations*, Resources for the Future, Washington D.C., (1981).
105. C. Flavin and N. Lenssen, *Beyond the Petroleum Age: Designing a Solar Economy*, Worldwatch Paper 100, Worldwatch Institute, Washington D.C., (1990).
106. C. Flavin and N. Lenssen, *The Power Surge. Guide to the Coming Energy Revolution*, W.W. Norton, New York, (1994).

107. J. Gever et al., *Beyond Oil. The Threat to Food and Fuel in the Coming Decades*, Ballinger, Cambridge Massachusetts, (1986).
108. E.A. Hiller and B.A. Stout, *Biomass Energy. A Monograph*, Texas A&M University Press, College Station, Texas, (1985).
109. T.B. Johansson et al., (editors), *Renewable Energy: Sources for Fuels and Electricity*, Island Press, Washington D.C., (1982).
110. D. Knott, *Hydrogen: The Fuel of the Future?*, Oil and Gas Journal, May, 26, (1994).
111. D.K. McDaniels, *The Sun: Our Future Energy Source* Second Edition, Krieger, Malabar Florida, (1994).
112. D. Pimentel, *Renewable Energy: Economic and Environmental Issues*, BioScience, **44**, 536-547, (1994).
113. D. Ross, *Power From the Waves*, Oxford University Press, (1995).
114. S. Sanchez, *Movement is in the Air As Texas Taps the Wind*, USA Today, November, (1995).
115. C.C. Swan, *Suncell. Energy, Economics and Photovoltaics*, Sierra Club Books, San Francisco, (1986).
116. I. Wickelgren, *Sunup at Last for Solar?*, Business Week, July 24, 84,86, (1995).
117. K. Zweibel, *Thin-film Photovoltaic Cells*, American Scientist, **81**, 362-369, (1993).
118. R. Golob and E. Brus, *The Almanac of Renewable Energy. The Complete Guide to Emerging Energy Technologies*, Henry Holt and Company, New York, (1993).

Chapter 3

THE DANGER OF THERMONUCLEAR WAR

3.1 Militarism and money

Military-industrial complexes throughout the world involve a circular flow of money. The vast profits from arms industries are used to buy the votes of politicians, who then vote for obscenely bloated “defence” budgets. Military-industrial complexes need enemies. Without them they would wither. Thus, tensions are manufactured by corrupt politicians in the pay of arms industries. As Arundhati Roy famously observed, “Once weapons were manufactured to fight wars. Now wars are manufactured to sell weapons.” Donald Trump has recently threatened to attack both Iran and North Korea with nuclear weapons. The United States, under Trump, is also threatening both Russia and China. Any such conflict could escalate uncontrollably into an all-destroying global thermonuclear war.

3.2 Ethology

In the long run, because of the terrible weapons that have already been produced through the misuse of science, and because of the even more terrible weapons that are likely to be invented in the future, the only way in which we can ensure the survival of civilization is to abolish the institution of war. But is this possible? Or are the emotions that make war possible so much a part of human nature that we cannot stop humans from fighting any more than we can stop cats and dogs from fighting? Can biological science throw any light on the problem of why our supposedly rational species seems intent on choosing war, pain and death instead of peace, happiness and life? To answer this question, we need to turn to the science of ethology - the study of inherited emotional tendencies and behavior patterns in animals and humans.

In *The Origin of Species*, Charles Darwin devoted a chapter to the evolution of instincts, and he later published a separate book on *The Expression of the Emotions in Man and Animals*. Because of these pioneering studies, Darwin is considered to be the founder of

ethology.

The study of inherited behavior patterns in animals (and humans) was continued in the 20th century by such researchers as Karl von Frisch (1886-1982), Nikolaas Tinbergen (1907-1988), and Konrad Lorenz (1903-1989), three scientists who shared a Nobel Prize in Medicine and Physiology in 1973.

The third of the 1973 prizewinners, Konrad Lorenz, is controversial, but at the same time very interesting in the context of studies of the causes of war and discussions of how war may be avoided. As a young boy, he was very fond of animals, and his tolerant parents allowed him to build up a large menagerie in their house in Altenberg, Austria. Even as a child, he became an expert on waterfowl behavior, and he discovered the phenomenon of imprinting. He was given a one day old duckling, and found, to his intense joy, that it transferred its following response to his person. As Lorenz discovered, young waterfowl have a short period immediately after being hatched, when they identify as their "mother" whomever they see first. In later life, Lorenz continued his studies of imprinting, and there exists a touching photograph of him, with his white beard, standing waist-deep in a pond, surrounded by an adoring group of goslings who believe him to be their mother. Lorenz also studied bonding behavior in waterfowl.

It is, however, for his controversial book *On Aggression* that Konrad Lorenz is best known. In this book, Lorenz makes a distinction between intergroup aggression and intragroup aggression. Among animals, he points out, rank-determining fights are seldom fatal. Thus, for example, the fights that determine leadership within a wolf pack end when the loser makes a gesture of submission. By contrast, fights between groups of animals are often fights to the death, examples being wars between ant colonies, or of bees against intruders, or the defense of a rat pack against strange rats.

Many animals, humans included, seem willing to kill or be killed in defense of the communities to which they belong. Lorenz calls this behavioral tendency a "communal defense response". He points out that the "holy shiver" - the tingling of the spine that humans experience when performing a heroic act in defense of their communities - is related to the prehuman reflex for raising the hair on the back of an animal as it confronts an enemy - a reflex that makes the animal seem larger than it really is.

In his book *On Aggression*, Konrad Lorenz gives the following description of the emotions of a hero preparing to risk his life for the sake of the group:

"In reality, militant enthusiasm is a specialized form of communal aggression, clearly distinct from and yet functionally related to the more primitive forms of individual aggression. Every man of normally strong emotions knows, from his own experience, the subjective phenomena that go hand in hand with the response of militant enthusiasm. A shiver runs down the back and, as more exact observation shows, along the outside of both arms. One soars elated, above all the ties of everyday life, one is ready to abandon all for the call of what, in the moment of this specific emotion, seems to be a sacred duty. All obstacles in its path become unimportant; the instinctive inhibitions against hurting or killing one's fellows lose, unfortunately, much of their power. Rational considerations, criticisms, and all reasonable arguments against the behavior dictated by militant enthusiasm are silenced by an amazing reversal of all values, making them appear not only untenable,

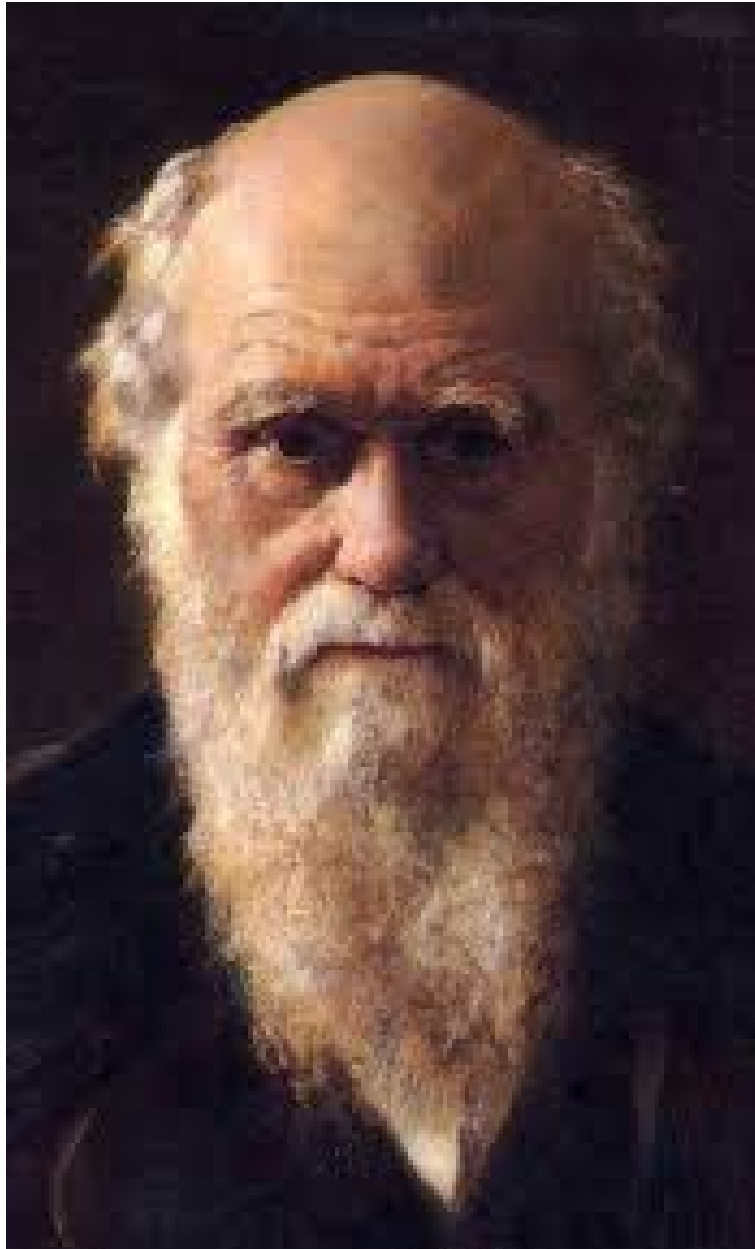

Figure 3.1: Because of Charles Darwin's book "The Expression of Emotions in Man and Animals", he is considered to be the founder of the field of Ethology, the study of inherited behavior patterns.



Figure 3.2: Nikolaas Tinbergen (1907-1988) on the left, with Konrad Lorenz (1903-1989). Together with Karl von Frisch (1886-1982) they shared the 1973 Nobel Prize in Physiology and Medicine for their pioneering work in Ethology.



Figure 3.3: Konrad Lorenz with geese who consider him to be their mother.

but base and dishonorable.

Men may enjoy the feeling of absolute righteousness even while they commit atrocities. Conceptual thought and moral responsibility are at their lowest ebb. As the Ukrainian proverb says: ‘When the banner is unfurled, all reason is in the trumpet.’”

“The subjective experiences just described are correlated with the following objectively demonstrable phenomena. The tone of the striated musculature is raised, the carriage is stiffened, the arms are raised from the sides and slightly rotated inward, so that the elbows point outward. The head is proudly raised, the chin stuck out, and the facial muscles mime the ‘hero face’ familiar from the films. On the back and along the outer surface of the arms, the hair stands on end. This is the objectively observed aspect of the shiver!”

“Anybody who has ever seen the corresponding behavior of the male chimpanzee defending his band or family with self-sacrificing courage will doubt the purely spiritual character of human enthusiasm. The chimp, too, sticks out his chin, stiffens his body, and raises his elbows; his hair stands on end, producing a terrifying magnification of his body contours as seen from the front. The inward rotation of the arms obviously has the purpose of turning the longest-haired side outward to enhance the effect. The whole combination of body attitude and hair-raising constitutes a bluff. This is also seen when a cat humps its back, and is calculated to make the animal appear bigger and more dangerous than it really is. Our shiver, which in German poetry is called a ‘heiliger Schauer’, a ‘holy’ shiver, turns out to be the vestige of a prehuman vegetative response for making a fur bristle which we no longer have. To the humble seeker for biological truth, there cannot be the slightest doubt that human militant enthusiasm evolved out of a communal defense response of our prehuman ancestor.”

Lorenz goes on to say, “An impartial visitor from another planet, looking at man as he is today - in his hand the atom bomb, the product of his intelligence - in his heart the aggression drive, inherited from his anthropoid ancestors, which the same intelligence cannot control - such a visitor would not give mankind much chance of survival.”

In an essay entitled *The Urge to Self-Destruction*¹, Arthur Koestler says:

“Even a cursory glance at history should convince one that individual crimes, committed for selfish motives, play a quite insignificant role in the human tragedy compared with the numbers massacred in unselfish love of one’s tribe, nation, dynasty, church or ideology... Wars are not fought for personal gain, but out of loyalty and devotion to king, country or cause...”

“We have seen on the screen the radiant love of the Führer on the faces of the Hitler Youth... They are transfixed with love, like monks in ecstasy on religious paintings. The sound of the nation’s anthem, the sight of its proud flag, makes you feel part of a wonderfully loving community. The fanatic is prepared to lay down his life for the object of his worship, as the lover is prepared to die for his idol. He is, alas, also prepared to kill anybody who represents a supposed threat to the idol.” The emotion described here by Koestler is the same as the communal defense mechanism (“militant enthusiasm”) described in

¹in *The Place of Value in a World of Facts*, A. Tiselius and S. Nielsson editors, Wiley, New York, (1970)

biological terms by Lorenz.

Generations of schoolboys have learned the Latin motto: “*Dulce et decorum est pro patria mori*” - it is both sweet and noble to die for one’s country. Even in today’s world, death in battle in defense of country and religion is still praised by nationalists. However, because of the development of weapons of mass destruction, both nationalism and narrow patriotism have become dangerous anachronisms.

In thinking of violence and war, we must be extremely careful not to confuse the behavioral patterns that lead to wife-beating or bar-room brawls with those that lead to episodes like the trench warfare of the First World War, or to the nuclear bombing of Hiroshima and Nagasaki. The first type of aggression is similar to the rank-determining fights of animals, while the second is more akin to the team-spirit exhibited by a football side. Heroic behavior in defense of one’s community has been praised throughout the ages, but the tendency to such behavior has now become a threat to the survival of civilization, since tribalism makes war possible, and war with thermonuclear weapons threatens civilization with catastrophe.

Warfare involves not only a high degree of aggression, but also an extremely high degree of altruism. Soldiers kill, but they also sacrifice their own lives. Thus patriotism and duty are as essential to war as the willingness to kill. As Arthur Koestler points out, “Wars are not fought for personal gain, but out of loyalty and devotion to king, country or cause...”

Tribalism involves passionate attachment to one’s own group, self-sacrifice for the sake of the group, willingness both to die and to kill if necessary to defend the group from its enemies, and belief that in case of a conflict, one’s own group is always in the right.

3.3 Population genetics

If we examine altruism and aggression in humans, we notice that members of our species exhibit great altruism towards their own children. Kindness towards close relatives is also characteristic of human behavior, and the closer the biological relationship is between two humans, the greater is the altruism they tend to show towards each other. This profile of altruism is easy to explain on the basis of Darwinian natural selection since two closely related individuals share many genes and, if they cooperate, the genes will be more effectively propagated.

To explain from an evolutionary point of view the communal defense mechanism discussed by Lorenz - the willingness of humans to kill and be killed in defense of their communities - we have only to imagine that our ancestors lived in small tribes and that marriage was likely to take place within a tribe rather than across tribal boundaries. Under these circumstances, each tribe would tend to consist of genetically similar individuals. The tribe itself, rather than the individual, would be the unit on which the evolutionary forces of natural selection would act. The idea of group selection in evolution was proposed in the 1930’s by J.B.S. Haldane and R.A. Fisher, and more recently it has been discussed by W.D. Hamilton and E.O. Wilson.

According to the group selection model, a tribe whose members showed altruism to-



Figure 3.4: Sir Ronald Aylmer Fisher (1890-1962). Together with J.B.S Haldane he pioneered the theory of population genetics. Recent contributions to this theory have been made by W.D. Hamilton and E.O. Wilson.

wards each other would be more likely to survive than a tribe whose members cooperated less effectively. Since several tribes might be in competition for the same territory, intertribal aggression might, under some circumstances, increase the chances for survival of one's own tribe. Thus, on the basis of the group selection model, one would expect humans to be kind and cooperative towards members of their own group, but at the same time to sometimes exhibit aggression towards members of other groups, especially in conflicts over territory. One would also expect intergroup conflicts to be most severe in cases where the boundaries between groups are sharpest - where marriage is forbidden across the boundaries.

3.4 Hope for the future

Although humans originally lived in small, genetically homogeneous tribes, the social and political groups of the modern world are much larger, and are often multiracial and multiethnic.

There are a number of large countries that are remarkable for their diversity, for example Brazil, Argentina and the United States. Nevertheless it has been possible to establish social cohesion and group identity within each of these enormous nations. India and China too, are mosaics of diverse peoples, but nevertheless, they function as coherent societies. Thus we see that group identity is a social construction, in which artificial "tribal markings" define the boundaries of the group. These tribal markings will be discussed in more detail below.

One gains hope for the future by observing how it has been possible to produce both internal peace and social cohesion over very large areas of the globe - areas that contain extremely diverse populations. The difference between making large, ethnically diverse countries function as coherent sociopolitical units and making the entire world function as a unit is not very great.

Since group identity is a social construction, it is not an impossible goal to think of enlarging the already-large groups of the modern world to include all of humanity.

On our small but beautiful earth, made small by technology, made beautiful by nature, there is room for one group only: the all-inclusive family of humankind.

3.5 Religion and ethnic identity

An acceleration of human cultural development seems to have begun approximately 70,000 years ago. The first art objects date from that period, as do migrations that ultimately took modern man across the Bering Strait to the western hemisphere. A land bridge extending from Siberia to Alaska is thought to have been formed approximately 70,000 years ago, disappearing again roughly 10,000 years before the present. Cultural and genetic studies indicate that migrations from Asia to North America took place during this period.

Shamanism,² which is found both in Asia and the new world, as well as among the Sami (Lapps) of northern Scandinavia, is an example of the cultural links between the hunting societies of these regions.

Before the acceleration of human cultural development just mentioned, genetic change and cultural change went hand in hand, but during the last 70,000 years, the constantly accelerating rate of information-accumulation and cultural evolution has increasingly out-distanced the rate of genetic change in humans. Genetically we are almost identical with our hunter-gatherer ancestors of 70,000 years ago, but cultural evolution has changed our way of life beyond recognition.

Humans are capable of cultural evolution because it is so easy to overwrite and modify our instinctive behavior patterns with learned behavior. Within the animal kingdom, humans are undoubtedly the champions in this respect. No other species is so good at learning as we are. During the early stages of cultural evolution, the tendency of humans to be religious may have facilitated the overwriting of instinctive behavior with the culture of the tribe. Since religions, like languages, are closely associated with particular cultures, they serve as marks of ethnic identity.

3.6 Tribal markings; ethnicity; pseudospeciation

In biology, a species is defined to be a group of mutually fertile organisms. Thus all humans form a single species, since mixed marriages between all known races will produce children, and subsequent generations in mixed marriages are also fertile. However, although there is never a biological barrier to marriages across ethnic and racial boundaries, there are often very severe cultural barriers.

Irenäus Eibl-Eibesfeldt, a student of Konrad Lorenz, introduced the word *pseudospeciation* to denote cases where cultural barriers between two groups of humans are so strongly marked that marriages across the boundary are difficult and infrequent. In such cases, he pointed out, the two groups function as though they were separate species, although from a biological standpoint this is nonsense. When two such groups are competing for the same land, the same water, the same resources, and the same jobs, the conflicts between them can become very bitter indeed. Each group regards the other as being “not truly human”.

In his book *The Biology of War and Peace*, Eibl-Eibesfeldt discusses the “tribal markings” used by groups of humans to underline their own identity and to clearly mark the boundary between themselves and other groups. One of the illustrations in the book shows the marks left by ritual scarification on the faces of the members of certain African tribes. These scars would be hard to counterfeit, and they help to establish and strengthen tribal identity. Seeing a photograph of the marks left by ritual scarification on the faces of

²A shaman is a special member of a hunting society who, while in a trance, is thought to be able pass between the upper world, the present world, and the lower world, to cure illnesses, and to insure the success of a hunt.

African tribesmen, it is impossible not to be reminded of the dueling scars that Prussian army officers once used to distinguish their caste from outsiders.

Surveying the human scene, one can find endless examples of signs that mark the bearer as a member of a particular group - signs that can be thought of as "tribal markings": tattoos; piercing; bones through the nose or ears; elongated necks or ears; filed teeth; Chinese binding of feet; circumcision, both male and female; unique hair styles; decorations of the tongue, nose, or naval; peculiarities of dress, fashions, veils, chadors, and headdresses; caste markings in India; use or nonuse of perfumes; codes of honor and value systems; traditions of hospitality and manners; peculiarities of diet (certain foods forbidden, others preferred); giving traditional names to children; knowledge of dances and songs; knowledge of recipes; knowledge of common stories, literature, myths, poetry or common history; festivals, ceremonies, and rituals; burial customs, treatment of the dead and ancestor worship; methods of building and decorating homes; games and sports peculiar to a culture; relationship to animals, knowledge of horses and ability to ride; nonrational systems of belief. Even a baseball hat worn backwards or the professed ability to enjoy atonal music can mark a person as a member of a special "tribe". Undoubtedly there many people in New York who would never think of marrying someone who could not appreciate the the paintings of Jasper Johns, and many in London who would consider anyone had not read all the books of Virginia Wolfe to be entirely outside the bounds of civilization.

By far the most important mark of ethnic identity is language, and within a particular language, dialect and accent. If the only purpose of language were communication, it would be logical for the people of a small country like Denmark to stop speaking Danish and go over to a more universally-understood international language such as English. However, language has another function in addition to communication: It is also a mark of identity. It establishes the boundary of the group.

Within a particular language, dialects and accents mark the boundaries of subgroups. For example, in England, great social significance is attached to accents and diction, a tendency that George Bernard Shaw satirized in his play, *Pygmalion*, which later gained greater fame as the musical comedy, *My Fair Lady*. This being the case, we can ask why all citizens of England do not follow the example of Eliza Doolittle in Shaw's play, and improve their social positions by acquiring Oxford accents. However, to do so would be to run the risk of being laughed at by one's peers and regarded as a traitor to one's own local community and friends. School children everywhere can be very cruel to any child who does not fit into the local pattern. At Eton, an Oxford accent is compulsory; but in a Yorkshire school, a child with an Oxford accent would suffer for it.

Next after language, the most important "tribal marking" is religion. As mentioned above, it seems probable that in the early history of our hunter-gatherer ancestors, religion evolved as a mechanism for perpetuating tribal traditions and culture. Like language, and like the innate facial expressions studied by Darwin, religion is a universal characteristic of all human societies. All known races and cultures practice some sort of religion. Thus a tendency to be religious seems to be built into human nature, or at any rate, the needs that religion satisfies seem to be a part of our inherited makeup. Otherwise, religion would not be so universal as it is.



Figure 3.5: A tatoed face can help to establish tribal identity



Figure 3.6: An example of the dueling scars that Prussian army officers once used to distinguish their caste from outsiders.

Religion is often strongly associated with ethnicity and nationalism, that is to say, it is associated with the demarcation of a particular group of people by its culture or race. For example, the Jewish religion is associated with Zionism and with Jewish nationalism. Similarly Islam is strongly associated with Arab nationalism. Christianity too has played an important role in many aggressive wars, for example in the Crusades, in the European conquest of the New World, in European colonial conquests in Africa and Asia, and in the wars between Catholics and Protestants within Europe. We shall see in a later chapter how the originators of the German nationalist movement (the precursors of the Nazis), used quasi-religious psychological methods.

Human history seems to be saturated with blood. It would be impossible to enumerate the conflicts with which the story of humankind is stained. Many of the atrocities of history have involved what Irenäus Eibl-Eibesfeldt called “pseudospeciation”, that is to say, they were committed in conflicts involving groups between which sharply marked cultural barriers have made intermarriage difficult and infrequent. Examples include the present conflict between Israelis and Palestinians; “racial cleansing” in Kosovo; the devastating wars between Catholics and Protestants in Europe; the Lebanese civil war; genocide committed against Jews and Gypsies during World War II; recent genocide in Rwanda; current intertribal massacres in the Ituri Province of Congo; use of poison gas against Kurdish civilians by Saddam Hussein’s regime in Iraq; the massacre of Armenians by Turks; massacres of Hindus by Muslims and of Muslims by Hindus in post-independence India; massacres of Native Americans by white conquerors and settlers in all parts of the New World; and massacres committed during the Crusades. The list seems almost endless.

Religion often contributes to conflicts by sharpening the boundaries between ethnic groups and by making marriage across those boundaries difficult and infrequent. However, this negative role is balanced by a positive one, whenever religion is the source of ethical principles, especially the principle of universal human brotherhood.

The religious leaders of today’s world have the opportunity to contribute importantly to the solution of the problem of war. They have the opportunity to powerfully support the concept of universal human brotherhood, to build bridges between religious groups, to make intermarriage across ethnic boundaries easier, and to soften the distinctions between communities. Our political leaders have the duty to move away from nationalism and militarism. If they fail to do this, they will have failed humankind at a time of great danger and crisis.



Figure 3.7: An illustration from Darwin's book, "The Expression of Emotions in Man and Animals". Here a cat raises its back and fur when confronting an enemy to make itself seem larger and more dangerous. This reflex was later discussed by the ethologist Konrad Lorenz.

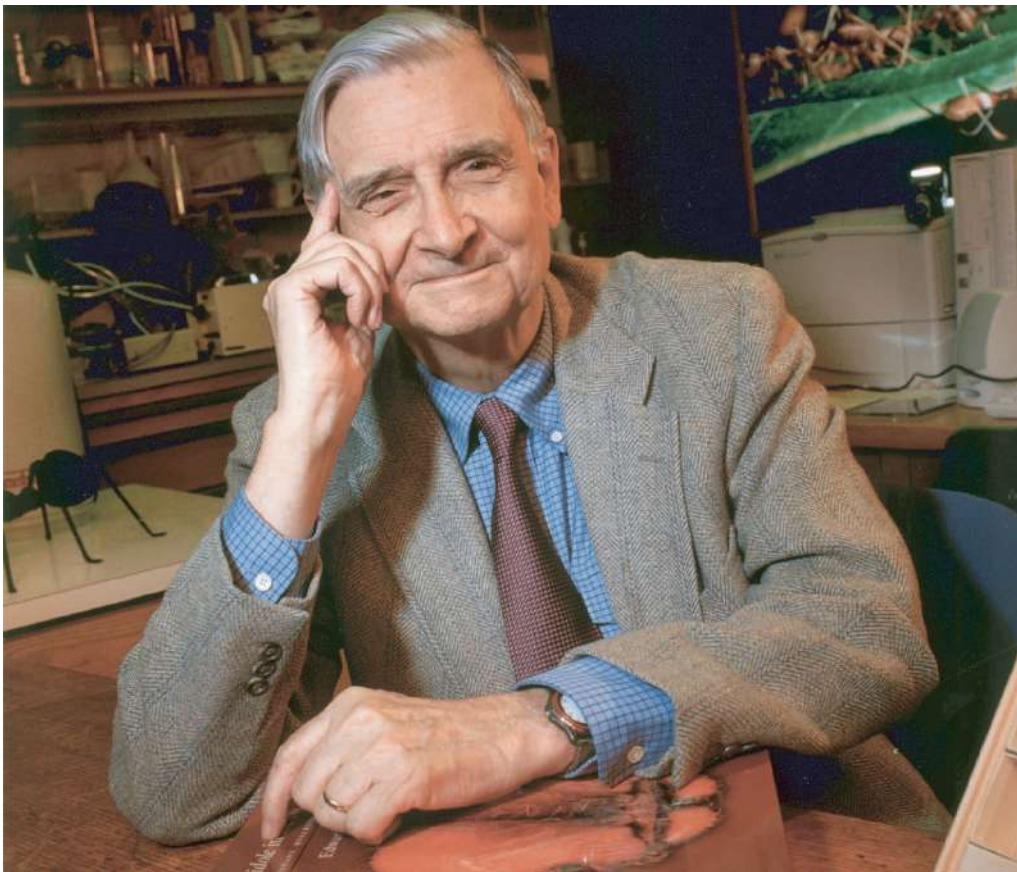

Figure 3.8: Professor E.O. Wilson of Harvard is famous for his books on Sociobiology.



Figure 3.9: **Professor Richard Dawkins of Oxford, controversial author of “The Selfish Gene” and many other books. He has contributed much to the debate on relationships between science, religion, aggression and altruism.**

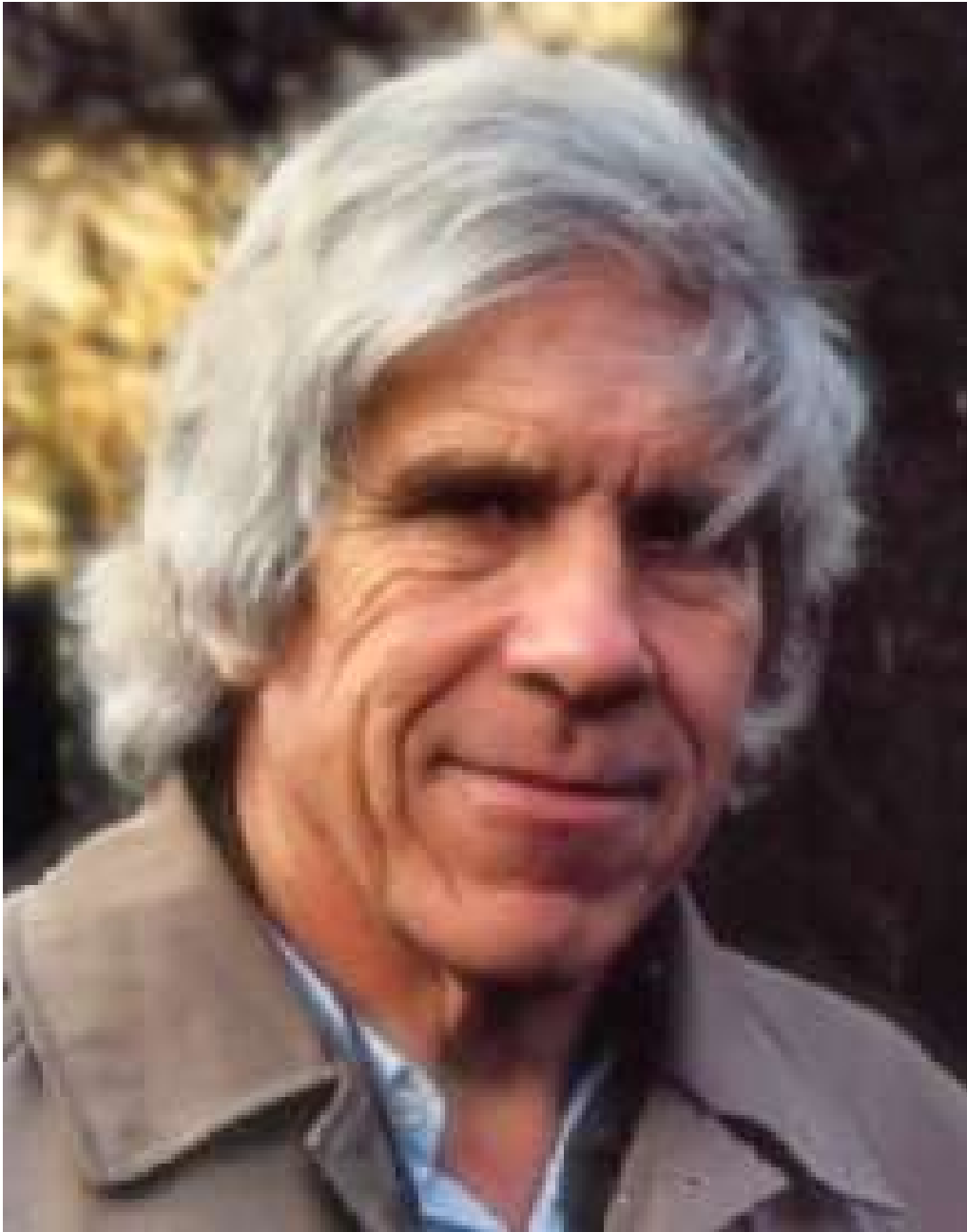

Figure 3.10: William Donald Hamilton was a Royal Society Research Professor at Oxford University until his death in 2000. He contributed importantly to our understanding of altruism from the standpoint of genetics.

3.7 The arms race prior to World War 1

The inherited tendency towards tribalism in human nature makes war possible. Humans are willing to kill and to be killed to defend their own group against perceived enemies. However, there is another element that drives and perpetuates the institution of war - the enormous amounts of money earned by arms manufacturers - the military-industrial complex against which Dwight D. Eisenhower warned in his famous farewell address.

In an article entitled *Arms Race Prior to 1914, Armament Policy*³, Eric Brose writes: “New weapons produced during the Industrial Revolution in the late 1800s heightened existing tensions among European nations as countries strove to outpace their enemies technologically. This armaments race accelerated in the decade before 1914 as the Triple Alliance of Germany, Austria-Hungary, and Italy squared off against the Triple Entente of France, Russia, and Britain. Germany’s fears of increases in Russian armaments, and British fears of the German naval buildup, contributed heavily to the outbreak and spread of the First World War in 1914.”

The Wikipedia article on *Arms race* states that “From 1897 to 1914, a naval arms race between the United Kingdom and Germany took place. British concern about rapid increase in German naval power resulted in a costly building competition of Dreadnought-class ships. This tense arms race lasted until 1914, when the war broke out. After the war, a new arms race developed among the victorious Allies, which was temporarily ended by the Washington Naval Treaty.

“In addition to the British and Germans, contemporaneous but smaller naval arms races also broke out between Russia and the Ottoman Empire; the Ottomans and Greece; France and Italy; the United States and Japan; and Brazil, Argentina, and Chile.

“The United Kingdom had the largest navy in the world. In accord with Wilhelm II’s enthusiasm for an expanded German navy and the strong desires of Grand Admiral Alfred von Tirpitz, Secretary of State of the German Imperial Naval Office, four Fleet Acts from 1898 and 1912 greatly expanded the German High Seas Fleet. The German aim was to build a fleet that would be two thirds the size of the British navy. The plan was sparked by the threat of the British Foreign Office in March 1897, after the British invasion of Transvaal that started the Boer War, of blockading the German coast and thereby crippling the German economy if Germany intervened in the conflict in Transvaal. From 1905 onward, the British navy developed plans for such a blockade, which was a central part of British strategy.

“In reaction to the challenge to its naval supremacy, from 1902 to 1910, the British Royal Navy embarked on a massive expansion to keep ahead of the Germans. The competition came to focus on the revolutionary new ships based on HMS Dreadnought, which was launched in 1906.”

³International Encyclopedia of the First World War

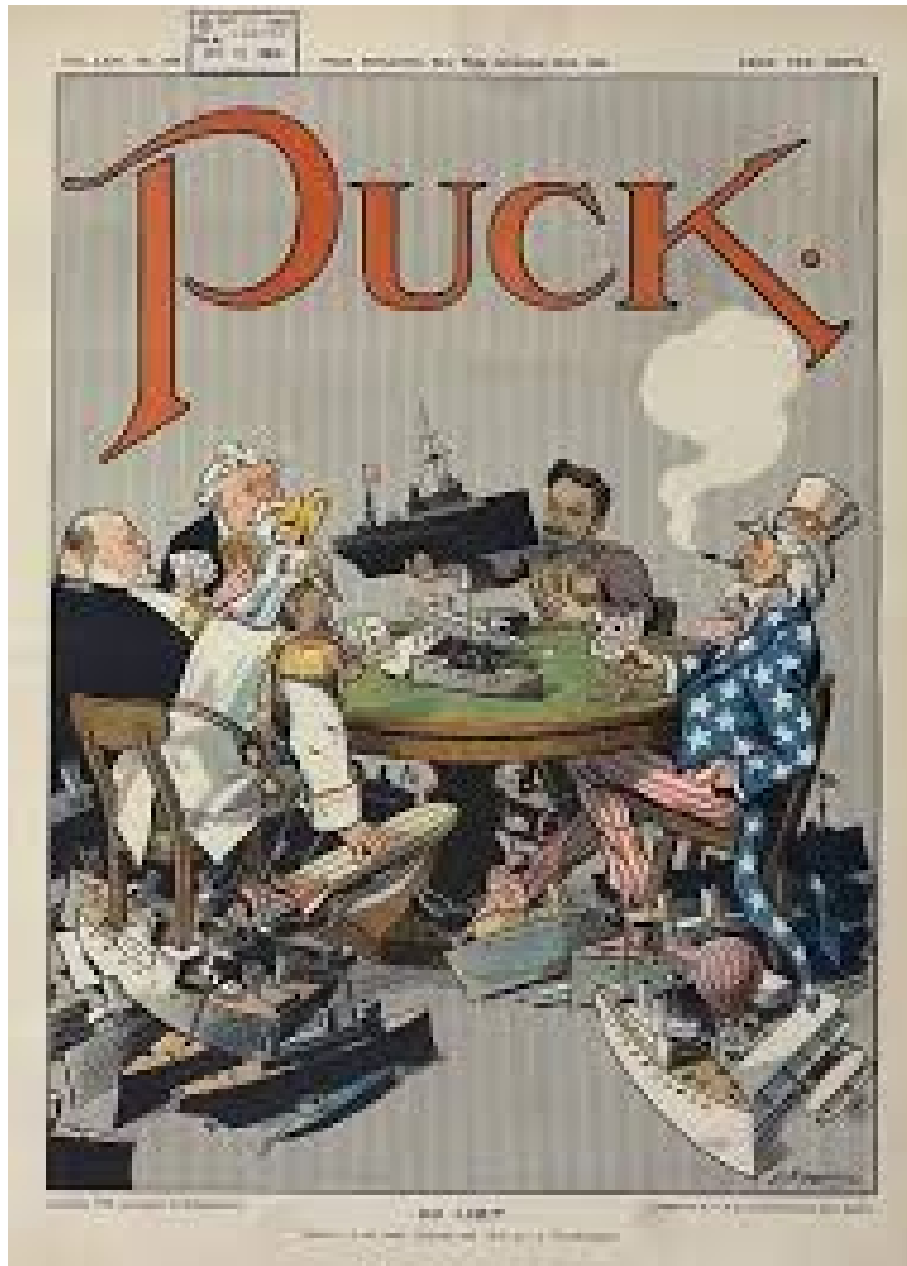

Figure 3.11: Left to right, US, Britain, Germany, France and Japan, engage in a “no limits” game for naval supremacy.

3.8 Krupp, Thyssen and Germany's steel industry

The Krupp family business, known as Friedrich Krupp AG, was the largest company in Europe at the beginning of the 20th century. It was important to weapons development and production in both world wars. One of the most powerful dynasties in European history, for 400 years Krupp flourished as the premier weapons manufacturer for Germany. From the Thirty Years' War until the end of the Second World War, they produced everything from battleships, U-boats, tanks, howitzers, guns, utilities, and hundreds of other commodities.

The Thyssen family similarly profited from the arms races prior to World War I and World War II. August Thyssen (1842-1925) founded a large iron and steel company in the Ruhr district of Germany, and was succeeded by his son Fritz Thyssen, who greatly aided Hitler's rise to power.

3.9 Colonialism and the outbreak of the First World War

The First World War broke out approximately 100 years ago, and much thought has been given to the causes of this tragic event, whose consequences continue to cast a dark shadow over the human future. When the war ended four years later, ten million young men had been killed and twenty million wounded, of whom six million were crippled for life. The war had cost 350,000,000,000 1919 dollars. This was a calculable cost; but the cost in human suffering and brutalization of values was incalculable.

It hardly mattered whose fault the catastrophe had been. Perhaps the Austrian government had been more to blame than any other. But blame for the war certainly did not rest with the Austrian people nor with the young Austrians who had been forced to fight. However, the tragedy of the First World War was that it created long-lasting hatred between the nations involved; and in this way it led, only twenty years later, to an even more catastrophic global war, during the course of which nuclear weapons were developed.

Most scholars believe that competing colonial ambitions played an important role in setting the stage for the First World War. A second factor was an armaments race between European countries, and the huge profits gained by arms manufacturers. Even at that time, the Military-industrial complex was firmly established; and today it continues to be the greatest source of war, together with neocolonialism.⁴

⁴<http://alphahistory.com/worldwar1/imperialism/>
<http://www.flowofhistory.com/units/etc/19/26>
<http://alphahistory.com/worldwar1/militarism/>



Figure 3.12: Map of European colonies in Africa in 1914, just before the First World War. Source: www.createdebate.com

3.10 Prescott Bush and Hitler

Prescott Sheldon Bush (1895-1972), the father of George H.W. Bush and grandfather of George W. Bush, actively supported the revival of Germany's armament's industry in the 1930's, as well as supplying large amounts of money to Adolf Hitler's Nazi Party.⁵

An article in *The Guardian*⁶, Ben Aris and Dubcab Campbell write that "George Bush's grandfather, the late US senator Prescott Bush, was a director and shareholder of companies that profited from their involvement with the financial backers of Nazi Germany.

"The Guardian has obtained confirmation from newly discovered files in the US National Archives that a firm of which Prescott Bush was a director was involved with the financial architects of Nazism.

"His business dealings, which continued until his company's assets were seized in 1942 under the Trading with the Enemy Act, has led more than 60 years later to a civil action for damages being brought in Germany against the Bush family by two former slave laborers at Auschwitz and to a hum of pre-election controversy.

"The debate over Prescott Bush's behavior has been bubbling under the surface for some time. There has been a steady Internet chatter about the "Bush/Nazi" connection,

⁵<https://www.youtube.com/watch?v=TnHnjmCYjy4>
<https://www.youtube.com/watch?v=7BZCfbrXKs4>
<https://www.youtube.com/watch?v=7BZCfbrXKs4>
<http://www.georgewalkerbush.net/bushfamilyfundedhitler.htm>
<http://www.theguardian.com/world/2004/sep/25/usa.secondworldwar>

⁶September 25, 2004



Figure 3.13: Prescott Bush, the father of George H.W. Bush and grandfather of George W. Bush, supported Hitler's rise to power with large financial contributions to the Nazi Party. The photo shows them together. Source: topinfo-post.com

much of it inaccurate and unfair. But the new documents, many of which were only declassified last year, show that even after America had entered the war and when there was already significant information about the Nazis' plans and policies, he worked for and profited from companies closely involved with the very German businesses that financed Hitler's rise to power. It has also been suggested that the money he made from these dealings helped to establish the Bush family fortune and set up its political dynasty.

"Bush was also on the board of at least one of the companies that formed part of a multinational network of front companies to allow [Fritz] Thyssen to move assets around the world.

"Thyssen owned the largest steel and coal company in Germany and grew rich from Hitler's efforts to re-arm between the two world wars. One of the pillars in Thyssen's international corporate web, UBC, worked exclusively for, and was owned by, a Thyssen-controlled bank in the Netherlands. More tantalizing are Bush's links to the Consolidated Silesian Steel Company (CSSC), based in mineral rich Silesia on the German-Polish border. During the war, the company made use of Nazi slave labor from the concentration camps, including Auschwitz. The ownership of CSSC changed hands several times in the 1930s, but documents from the US National Archive declassified last year link Bush to CSSC, although it is not clear if he and UBC were still involved in the company when Thyssen's American assets were seized in 1942."

3.11 Fritz Thyssen supports Hitler's rise to power

“In 1923, Thyssen met former General Erich Ludendorff, who advised him to attend a speech given by Adolf Hitler, leader of the Nazi Party. Thyssen was impressed by Hitler and his bitter opposition to the Treaty of Versailles, and began to make large donations to the party, including 100,000 gold marks in 1923 to Ludendorff. In this he was unusual among German business leaders, as most were traditional conservatives who regarded the Nazis with suspicion. Thyssen's principal motive in supporting the National Socialists was his great fear of communism; he had little confidence that the various German anticommunist factions would prevent a Soviet-style revolution in Germany unless the popular appeal of communism among the lower classes was co-opted by an anticommunist alternative. Postwar investigators found that he had donated 650,000 Reichsmarks to right-wing parties, mostly to the Nazis, although Thyssen himself claimed to have donated 1 million marks to the Nazi Party. Thyssen remained a member of the German National People's Party until 1932, and did not join the Nazi Party (National Socialist German Workers' Party) until 1933.

“In November, 1932, Thyssen and Hjalmar Schacht were the main organizers of a letter to President Paul von Hindenburg urging him to appoint Hitler as Chancellor. Thyssen also persuaded the Association of German Industrialists to donate 3 million Reichsmarks to the Nazi Party (National Socialist German Workers' Party) for the March, 1933 Reichstag election. As a reward, he was elected a Nazi member of the Reichstag and appointed to the Council of State of Prussia, the largest German state (both purely honorary positions).

“Thyssen welcomed the suppression of the Communist Party, the Social Democrats and the trade unions. In 1934 he was one of the business leaders who persuaded Hitler to suppress the SA, leading to the “Night of the Long Knives”. Thyssen accepted the exclusion of Jews from German business and professional life by the Nazis, and dismissed his own Jewish employees. But as a Catholic, he objected to the increasing repression of the Roman Catholic Church, which gathered pace after 1935: in 1937 he sent a letter to Hitler, protesting the persecution of Christians in Germany.[4] The breaking point for Thyssen was the violent pogrom against the Jews in November 1938, known as Kristallnacht, which caused him to resign from the Council of State. By 1939 he was also bitterly criticizing the regime's economic policies, which were subordinating everything to rearmament in preparation for war.”



Figure 3.14: An arms race between the major European powers contributed to the start of World War I.



Figure 3.15: World War I was called “The War to End All Wars”. Today it seems more like The War that Began All Wars.



Figure 3.16: The naval arms race, which contributed to the start of World War I, enriched steel manufacturers and military shipbuilders.



Figure 3.17: Who is the leader, and who the follower?

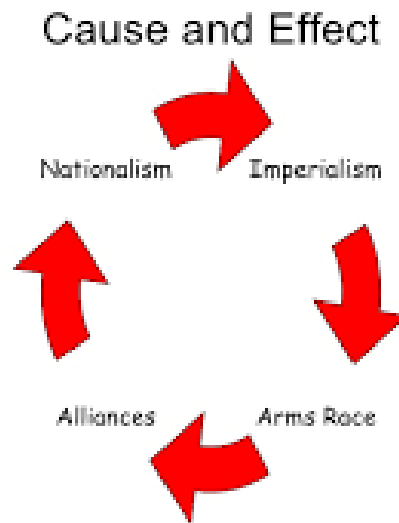

Figure 3.18: A vicious circle.



Figure 3.19: Ready, set, go!

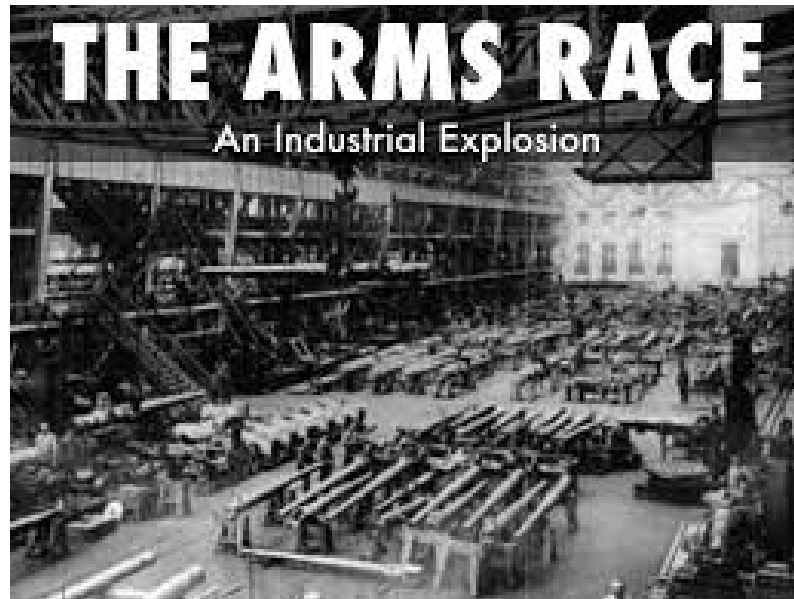

Figure 3.20: If our economies depend on armaments industries, it is an unhealthy dependence, analogous to drug addiction.



Figure 3.21: The nuclear arms race casts a dark shadow over the future of human civilization and the biosphere.



Figure 3.22: During the Cuban Missile Crisis, the world came close to a catastrophic thermonuclear war.

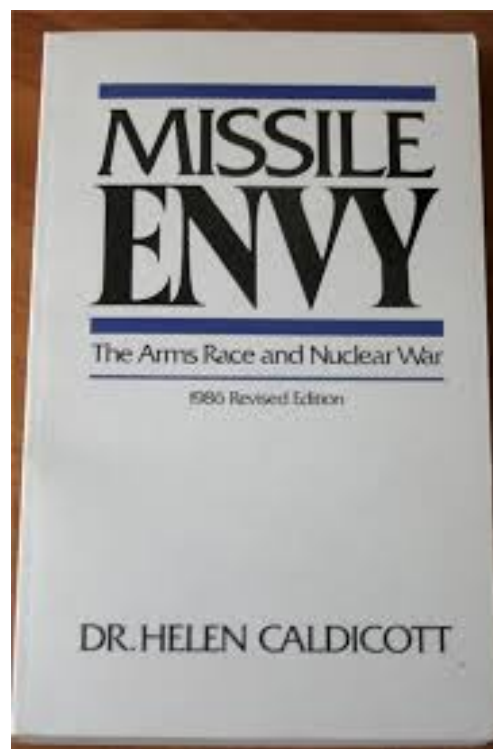

Figure 3.23: Dr. Helen Caldecott has worked to document the dangers of both nuclear weapons and nuclear power generation.



Figure 3.24: We must listen to the wise words of Dr. Martin Luther King, Jr.

3.12 Eisenhower's farewell address

In his famous farewell address, US President Dwight Eisenhower eloquently described the terrible effects of an overgrown Military-industrial complex. Here are his words:

“We have been compelled to create a permanent armaments industry of vast proportions.... This conjunction of an immense military establishment and a large arms industry is new in the American experience. The total influence, economic, political, even spiritual, is felt in every city, every State house, every office of the Federal government...[and] we must not fail to comprehend its grave implications. Our toil, resources and livelihood are all involved; so is the very structure of our society.

“In the councils of government, we must guard against the acquisition of unwarranted influence, whether sought or unsought, by the Military-industrial complex. The potential for the disastrous rise of misplaced power exists and will persist.”

In another speech, he said: “Every gun that is made, every warship launched, every rocket fired signifies, in the final sense, a theft from those who hunger and are not fed, those who are cold and are not clothed. This world in arms is not spending money alone. It is spending the sweat of its laborers, the genius of its scientists, the hopes of its children.”

Today the world spends more than 1.7 trillion dollars (\$ 1,700,000,000,000) every year on armaments. This vast river of money, almost too large to be imagined, is the “devil's dynamo” driving the institution of war. Politicians notoriously can be bought with a tiny fraction of this enormous amount; hence the decay of democracy. It is also plain that if the almost unbelievable sums now wasted on armaments were used constructively, most of the pressing problems now facing humanity could be solved.

Because the world spends almost two thousand billion dollars each year on armaments, it follows that very many people make their living from war. This is the reason why it is correct to speak of war as an institution, and why it persists, although we know that it is the cause of much of the suffering that inflicts humanity.

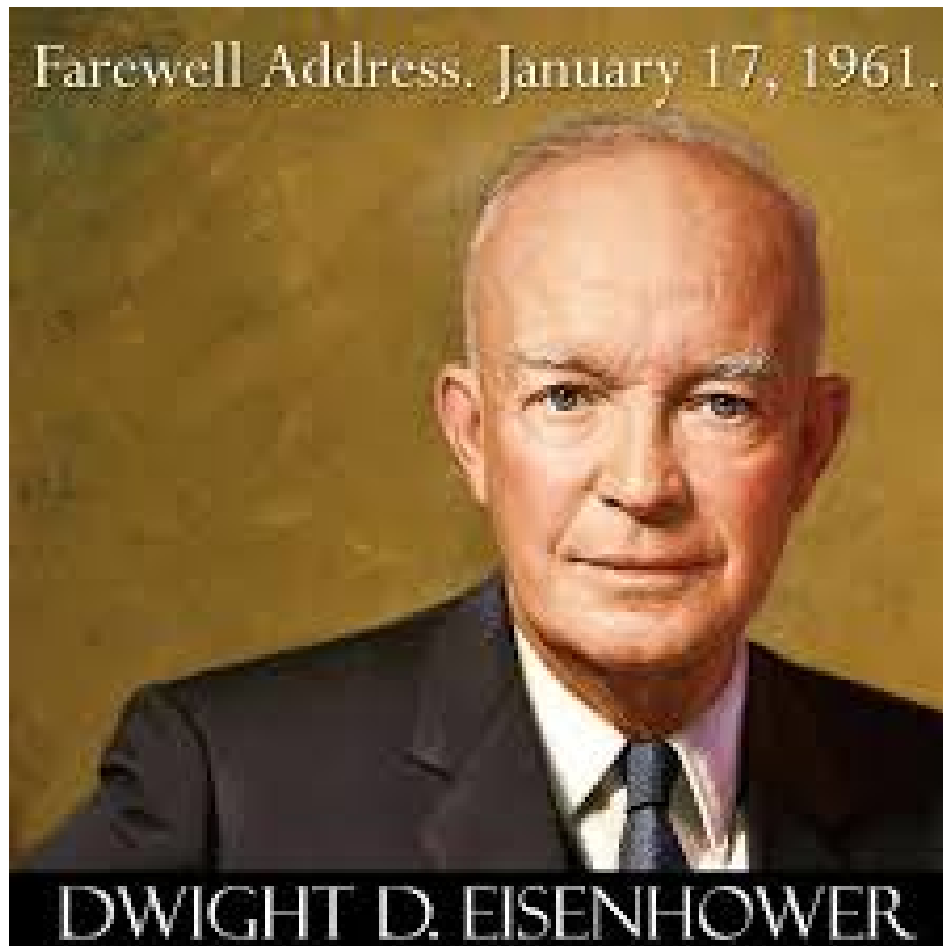

Figure 3.25: “In the councils of government, we must guard against the acquisition of unwarranted influence, whether sought or unsought, by the Military-industrial complex. The potential for the disastrous rise of misplaced power exists and will persist.”

3.13 The nuclear arms race

Flaws in the concept of nuclear deterrence

Before discussing other defects in the concept of deterrence, it must be said very clearly that the idea of “massive nuclear retaliation” is completely unacceptable from an ethical point of view. The doctrine of retaliation, performed on a massive scale, violates not only the principles of common human decency and common sense, but also the ethical principles of every major religion. Retaliation is especially contrary to the central commandment of Christianity which tells us to love our neighbor, even if he or she is far away from us, belonging to a different ethnic or political group, and even if our distant neighbor has seriously injured us. This principle has a fundamental place not only in Christianity but also in all other major religions. “Massive retaliation” completely violates these very central ethical principles, which are not only clearly stated and fundamental but also very practical, since they prevent escalatory cycles of revenge and counter-revenge.

Contrast Christian ethics with estimates of the number of deaths that would follow a US nuclear strike against Russia: Several hundred million deaths. These horrifying estimates shock us not only because of the enormous magnitude of the expected mortality, but also because the victims would include people of every kind: women, men, old people, children and infants, completely irrespective of any degree of guilt that they might have. As a result of such an attack, many millions of people in neutral countries would also die. This type of killing has to be classified as genocide.

When a suspected criminal is tried for a wrongdoing, great efforts are devoted to clarifying the question of guilt or innocence. Punishment only follows if guilt can be proved beyond any reasonable doubt. Contrast this with the totally indiscriminate mass slaughter that results from a nuclear attack!

It might be objected that disregard for the guilt or innocence of victims is a universal characteristic of modern war, since statistics show that, with time, a larger and larger percentage of the victims have been civilians, and especially children. For example, the air attacks on Coventry during World War II, or the fire bombings of Dresden and Tokyo, produced massive casualties which involved all segments of the population with complete disregard for the question of guilt or innocence. The answer, I think, is that modern war has become generally unacceptable from an ethical point of view, and this unacceptability is epitomized in nuclear weapons.

The enormous and indiscriminate destruction produced by nuclear weapons formed the background for an historic 1996 decision by the International Court of Justice in the Hague. In response to questions put to it by WHO and the UN General Assembly, the Court ruled that “the threat and use of nuclear weapons would generally be contrary to the rules of international law applicable in armed conflict, and particularly the principles and rules of Humanitarian law.”

The only *possible* exception to this general rule might be “an extreme circumstance of self-defense, in which the very survival of a state would be at stake”. But the Court refused to say that even in this extreme circumstance the threat or use of nuclear weapons



would be legal. It left the exceptional case undecided. In addition, the World Court added unanimously that “there exists an obligation to pursue in good faith *and bring to a conclusion* negotiations leading to nuclear disarmament in all its aspects under strict international control.”

This landmark decision has been criticized by the nuclear weapon states as being decided “by a narrow margin”, but the structuring of the vote made the margin seem more narrow than it actually was. Seven judges voted against Paragraph 2E of the decision (the paragraph which states that the threat or use of nuclear weapons would be generally illegal, but which mentions as a possible exception the case where a nation might be defending itself from an attack that threatened its very existence.) Seven judges voted for the paragraph, with the President of the Court, Muhammad Bedjaoui of Algeria casting the deciding vote. Thus the Court adopted it, seemingly by a narrow margin. But three of the judges who voted against 2E did so because they believed that no possible exception should be mentioned! Thus, if the vote had been slightly differently structured, the result would have been ten to four.

Of the remaining four judges who cast dissenting votes, three represented nuclear weapons states, while the fourth thought that the Court ought not to have accepted the questions from WHO and the UN. However Judge Schwebel from the United States, who voted against Paragraph 2E, nevertheless added, in a separate opinion, “It cannot be accepted that the use of nuclear weapons on a scale which would - or could - result in the deaths of many millions in indiscriminate inferno and by far-reaching fallout, have pernicious effects in space and time, and render uninhabitable much of the earth, could be lawful.” Judge Higgins from the UK, the first woman judge in the history of the Court, had problems with the word “generally” in Paragraph 2E and therefore voted against it, but she thought that a more profound analysis might have led the Court to conclude in favor of illegality in all circumstances. Judge Fleischhauer of Germany said in his separate

opinion, “The nuclear weapon is, in many ways, the negation of the humanitarian considerations underlying the law applicable in armed conflict and the principle of neutrality. The nuclear weapon cannot distinguish between civilian and military targets. It causes immeasurable suffering. The radiation released by it is unable to respect the territorial integrity of neutral States.”

President Bedjaoui, summarizing the majority opinion, called nuclear weapons “the ultimate evil”, and said “By its nature, the nuclear weapon, this blind weapon, destabilizes Humanitarian law, the law of discrimination in the use of weapons... The ultimate aim of every action in the field of nuclear arms will always be nuclear disarmament, an aim which is no longer utopian and which all have a duty to pursue more actively than ever.”

Thus the concept of nuclear deterrence is not only unacceptable from the standpoint of ethics; it is also contrary to international law. The World Court’s 1996 advisory Opinion unquestionably also represents the opinion of the majority of the world’s peoples. Although no formal plebiscite has been taken, the votes in numerous resolutions of the UN General Assembly speak very clearly on this question. For example the New Agenda Resolution (53/77Y) was adopted by the General Assembly on 4 December 1998 by a massively affirmative vote, in which only 18 out of the 170 member states voted against the resolution.⁷ The New Agenda Resolution proposes numerous practical steps towards complete nuclear disarmament, and it calls on the Nuclear-Weapon States “to demonstrate an unequivocal commitment to the speedy and total elimination of their nuclear weapons and without delay to pursue in good faith and bring to a conclusion negotiations leading to the elimination of these weapons, thereby fulfilling their obligations under Article VI of the Treaty on the Non-Proliferation of Nuclear Weapons (NPT)”. Thus, in addition to being ethically unacceptable and contrary to international law, nuclear weapons also contrary to the principles of democracy.

Having said these important things, we can now turn to some of the other defects in the concept of nuclear deterrence. One important defect is that nuclear war may occur through accident or miscalculation - through technical defects or human failings. This possibility is made greater by the fact that despite the end of the Cold War, thousands of missiles carrying nuclear warheads are still kept on a “hair-trigger” state of alert with a quasi-automatic reaction time measured in minutes. There is a constant danger that a nuclear war will be triggered by error in evaluating the signal on a radar screen. For example, the BBC reported recently that a group of scientists and military leaders are worried that a small asteroid entering the earths atmosphere and exploding could trigger a nuclear war if mistaken for a missile strike.

A number of prominent political and military figures (many of whom have ample knowledge of the system of deterrence, having been part of it) have expressed concern about the danger of accidental nuclear war. Colin S. Grey⁸ expressed this concern as follows: “The problem, indeed the enduring problem, is that we are resting our future upon a nuclear

⁷Of the 18 countries that voted against the New Agenda resolution, 10 were Eastern European countries hoping for acceptance into NATO, whose votes seem to have been traded for increased probability of acceptance.

⁸Chairman, National Institute for Public Policy

deterrence system concerning which we cannot tolerate even a single malfunction.” General Curtis E. LeMay⁹ has written, “In my opinion a general war will grow through a series of political miscalculations and accidents rather than through any deliberate attack by either side.” Bruce G. Blair¹⁰ has remarked that “It is obvious that the rushed nature of the process, from warning to decision to action, risks causing a catastrophic mistake.”... “This system is an accident waiting to happen.”

“But nobody can predict that the fatal accident or unauthorized act will never happen”, Fred Ikle of the Rand Corporation has written, “Given the huge and far-flung missile forces, ready to be launched from land and sea on on both sides, the scope for disaster by accident is immense... In a matter of seconds - through technical accident or human failure - mutual deterrence might thus collapse.”

Another serious failure of the concept of nuclear deterrence is that it does not take into account the possibility that atomic bombs may be used by terrorists. Indeed, the threat of nuclear terrorism has today become one of the most pressing dangers that the world faces, a danger that is particularly acute in the United States.

Since 1945, more than 3,000 metric tons (3,000,000 kilograms) of highly enriched uranium and plutonium have been produced - enough for several hundred thousand nuclear weapons. Of this, roughly a million kilograms are in Russia, inadequately guarded, in establishments where the technicians are poorly paid and vulnerable to the temptations of bribery. There is a continuing danger that these fissile materials will fall into the hands of terrorists, or organized criminals, or irresponsible governments. Also, an extensive black market for fissile materials, nuclear weapons components etc. has recently been revealed in connection with the confessions of Pakistan’s bomb-maker, Dr. A.Q. Khan. Furthermore, if Pakistan’s less-than-stable government should be overthrown, complete nuclear weapons could fall into the hands of terrorists.

On November 3, 2003, Mohamed ElBaradei, Director General of the International Atomic Energy Agency, made a speech to the United Nations in which he called for “limiting the processing of weapons-usable material (separated plutonium and high enriched uranium) in civilian nuclear programmes - as well as the production of new material through reprocessing and enrichment - by agreeing to restrict these operations to facilities exclusively under international control.” It is almost incredible, considering the dangers of nuclear proliferation and nuclear terrorism, that such restrictions were not imposed long ago. Nuclear reactors used for “peaceful” purposes unfortunately also generate fissionable isotopes of plutonium, neptunium and americium. Thus all nuclear reactors must be regarded as ambiguous in function, and all must be put under strict international control. One might ask, in fact, whether globally widespread use of nuclear energy is worth the danger that it entails.

The Italian nuclear physicist Francesco Calogero, who has studied the matter closely, believes that terrorists could easily construct a simple gun-type nuclear bomb if they were in possession of a critical mass of highly enriched uranium. In such a simple atomic bomb,

⁹Founder and former Commander in Chief of the United States Strategic Air Command

¹⁰Brookings Institute

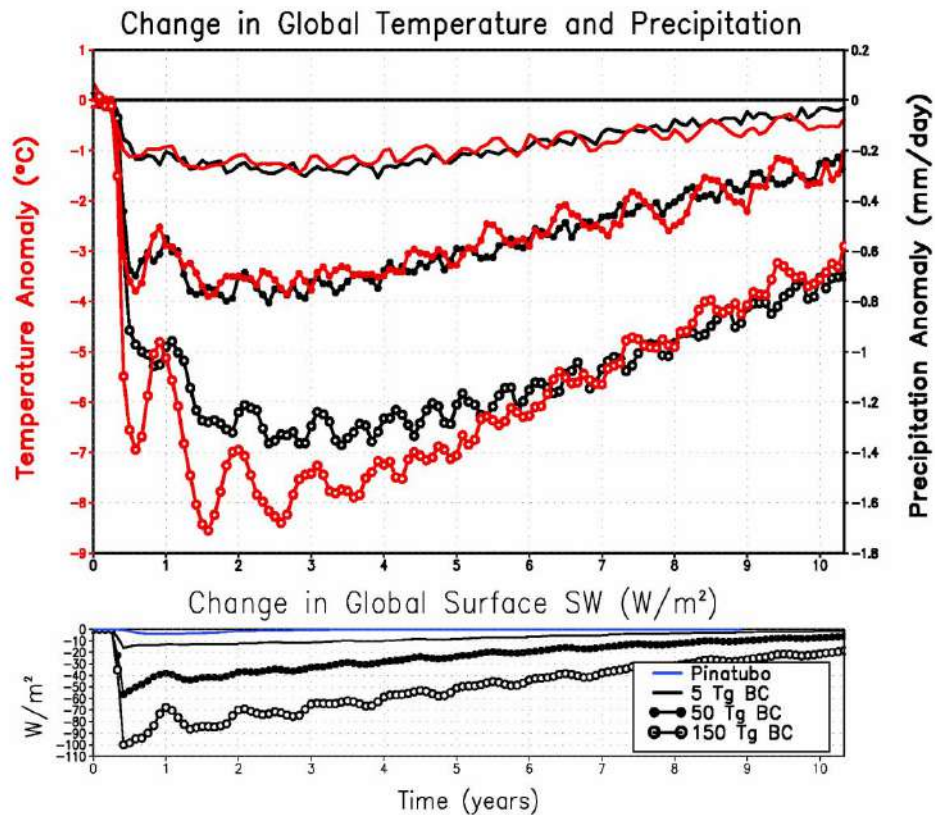

Figure 3.26: Recent studies by atmospheric scientists have shown that the smoke from burning cities produced by even a limited nuclear war would have a devastating effect on global agriculture. The studies show that the smoke would rise to the stratosphere, where it would spread globally and remain for a decade, blocking sunlight and destroying the ozone layer. Because of the devastating effect on global agriculture, darkness from even a small nuclear war (e.g. between India and Pakistan) would result in an estimated billion deaths from famine. Nuclear darkness resulting from a large-scale war involving all of the nuclear weapons that are now on high alert status would destroy all agriculture on earth for a period of ten years, and almost all humans would die of starvation. (See O. Toon, A. Robock, and R. Turco, “The Environmental Consequences of Nuclear War”, *Physics Today*, vol. 61, No. 12, 2008, p. 37-42).

two grapefruit-sized subcritical portions of HEU are placed at opposite ends of the barrel of an artillery piece and are driven together by means of a conventional explosive. Prof. Calogero estimates that the fatalities produced by the explosion of such a device in the center of a large city could exceed 100,000.

We must remember the remark of U.N. Secretary General Kofi Annan after the 9/11/2001 attacks on the World Trade Center. He said, “*This time* it was not a nuclear explosion”. The meaning of his remark is clear: If the world does not take strong steps to eliminate fissionable materials and nuclear weapons, it will only be a matter of time before they will be used in terrorist attacks on major cities. Neither terrorists nor organized criminals can be deterred by the threat of nuclear retaliation, since they have no territory against which such retaliation could be directed. They blend invisibly into the general population. Nor can a “missile defense system” prevent terrorists from using nuclear weapons, since the weapons can be brought into a port in any one of the hundreds of thousands of containers that enter on ships each year, a number far too large to be checked exhaustively.

Today we must give special weight to the danger that a catastrophic nuclear war may occur through the mental instability of a political leader or an error of judgement, since we now are living with Donald Trump and Kim Jong-un. In the words of ICAN’s Executive Director Beatrice Finn, the end of human civilization and much of the biosphere is “only a tantrum away”. Donald Trump has repeatedly expressed his desire for more “usable” nuclear weapons. and if nuclear weapons are ever used, there is a strong danger of escalation to a full-scale thermonuclear war.

Another problem with the concept of nuclear deterrence is that even if the danger that a catastrophic nuclear war will occur in any given year is small, over a long period of time the danger builds up into a certainty. If the dangers for any given year are 1%, 2% or 3%, the probabilities of are survival until 2100 are respectively 43%, 18% and 8%. If the period for which we must survive is extended to the year 2200, the chances of survival in the three cases are respectively .16%, .025%, and .0039%.

In this perilous situation, the only logical thing for the world to do is to get rid of both fissile materials and nuclear weapons as rapidly as possible. We must acknowledge that the idea of nuclear deterrence is a dangerous fallacy, and acknowledge that the development of military systems based on nuclear weapons has been a terrible mistake, a false step that needs to be reversed. If the most prestigious of the nuclear weapons states can sincerely acknowledge their mistakes and begin to reverse them, nuclear weapons will seem less glamorous to countries like India, Pakistan, North Korea and Iran, where they now are symbols of national pride and modernism.

Civilians have for too long played the role of passive targets, hostages in the power struggles of politicians. It is time for civil society to make its will felt. If our leaders continue to enthusiastically support the institution of war, if they will not abolish nuclear weapons, then let us have new leaders.

3.14 Global famine produced by nuclear war

The danger of a catastrophic nuclear war casts a dark shadow over the future of our species. It also casts a very black shadow over the future of the global environment. The environmental consequences of a massive exchange of nuclear weapons have been treated in a number of studies by meteorologists and other experts from both East and West. They predict that a large-scale use of nuclear weapons would result in fire storms with very high winds and high temperatures, which would burn a large proportion of the wild land fuels in the affected nations. The resulting smoke and dust would block out sunlight for a period of many months, at first only in the northern hemisphere but later also in the southern hemisphere.

Temperatures in many places would fall far below freezing, and much of the earth's plant life would be killed. Animals and humans would then die of starvation. The nuclear winter effect was first discovered as a result of the Mariner 9 spacecraft exploration of Mars in 1971. The spacecraft arrived in the middle of an enormous dust-storm on Mars, and measured a large temperature drop at the surface of the planet, accompanied by a heating of the upper atmosphere. These measurements allowed scientists to check their theoretical models for predicting the effect of dust and other pollutants distributed in planetary atmospheres.

Using experience gained from the studies of Mars, R.P. Turco, O.B. Toon, T. Ackerman, J.B. Pollack and C. Sagan made a computer study of the climatic effects of the smoke and dust that would result from a large-scale nuclear war. This early research project is sometimes called the TTAPS Study, after the initials of the authors.

In April 1983, a special meeting was held in Cambridge, Massachusetts, where the results of the TTAPS Study and other independent studies of the nuclear winter effect were discussed by more than 100 experts. Their conclusions were presented at a forum in Washington, D.C., the following December, under the chairmanship of U.S. Senators Kennedy and Hatfield. The numerous independent studies of the nuclear winter effect all agreed of the following main predictions:

High-yield nuclear weapons exploded near the earth's surface would put large amounts of dust into the upper atmosphere. Nuclear weapons exploded over cities, forests, oilfields and refineries would produce fire storms of the type experienced in Dresden and Hamburg after incendiary bombings during the Second World War. The combination of high-altitude dust and lower altitude soot would prevent sunlight from reaching the earth's surface, and the degree of obscuration would be extremely high for a wide range of scenarios.

A baseline scenario used by the TTAPS study assumes a 5,000-megaton nuclear exchange, but the threshold for triggering the nuclear winter effect is believed to be much lower than that. After such an exchange, the screening effect of pollutants in the atmosphere might be so great that, in the northern and middle latitudes, the sunlight reaching the earth would be only 1% of ordinary sunlight on a clear day, and this effect would persist for many months. As a result, the upper layers in the atmosphere might rise in temperature by as much as 100 °C, while the surface temperatures would fall, perhaps by as much as 50 °C.

The temperature inversion produced in this way would lead to superstability, a condition in which the normal mixing of atmospheric layers is suppressed. The hydrological cycle (which normally takes moist air from the oceans to a higher and cooler level, where the moisture condenses as rain) would be strongly suppressed. Severe droughts would thus take place over continental land masses. The normal cleansing action of rain would be absent in the atmosphere, an effect which would prolong the nuclear winter.

In the northern hemisphere, forests would die because of lack of sunlight, extreme cold, and drought. Although the temperature drop in the southern hemisphere would be less severe, it might still be sufficient to kill a large portion of the tropical forests, which normally help to renew the earth's oxygen.

The oxygen content of the atmosphere would then fall dangerously, while the concentration of carbon dioxide and oxides of nitrogen produced by firestorms would remain high. The oxides of nitrogen would ultimately diffuse to the upper atmosphere, where they would destroy the ozone layer.

Thus, even when the sunlight returned after an absence of many months, it would be sunlight containing a large proportion of the ultraviolet frequencies which are normally absorbed by the ozone in the stratosphere, and therefore a type of light dangerous to life. Finally, after being so severely disturbed, there is no guarantee that the global climate would return to its normal equilibrium.

Even a nuclear war below the threshold of nuclear winter might have climatic effects very damaging to human life. Professor Paul Ehrlich, of Stanford University, has expressed this in the following words:

"...A smaller war, which set off fewer fires and put less dust into the atmosphere, could easily depress temperatures enough to essentially cancel grain production in the northern hemisphere. That in itself would be the greatest catastrophe ever delivered upon Homo Sapiens, just that one thing, not worrying about prompt effects. Thus even below the threshold, one cannot think of survival of a nuclear war as just being able to stand up after the bomb has gone off."¹¹

¹¹<http://www.voanews.com/content/pope-francis-calls-for-nuclear-weapons-ban/2909357.html>
<http://www.cadmusjournal.org/article/issue-4/flaws-concept-nuclear-deterrence>
<http://www.countercurrents.org/avery300713.htm>
<https://www.wagingpeace.org/author/john-avery/>
<http://www.commondreams.org/news/2015/08/06/70-years-after-bombing-hiroshima-calls-abolish-nuclear-weapons>
<http://www.informationclearinghouse.info/article42488.htm>
<http://www.informationclearinghouse.info/article42492.htm>
<http://www.commondreams.org/views/2015/08/06/hiroshima-and-nagasaki-remembering-power>
<http://human-wrongs-watch.net/2015/07/22/israel-iran-and-the-nuclear-non-proliferation-treaty/>
<http://human-wrongs-watch.net/2015/06/25/militarisms-hostages/>
<http://human-wrongs-watch.net/2015/05/24/the-path-to-zero-dialogues-on-nuclear-dangers-by-richard-falk-and-david-krieger/>
<http://human-wrongs-watch.net/2015/03/30/europe-must-not-be-forced-into-a-nuclear-war-with-russia/>
<http://www.truth-out.org/opinion/item/32073-the-us-should-eliminate-its-nuclear-arsenal-not-modernize-it>
<http://www.cadmusjournal.org/article/issue-4/flaws-concept-nuclear-deterrence>

A 2012 report published by International Physicians for the Prevention of Nuclear War states that even a small local nuclear war between India and Pakistan would put two billion people at risk of starvation.

3.15 Military-industrial complexes today

“We’re going to take out seven countries in five years”

In an interview with Amy Goodman¹², retired 4-star General Wesley Clark said: “About ten days after 9/11, I went through the Pentagon and I saw Secretary Rumsfeld and Deputy Secretary Wolfowitz. I went downstairs just to say hello to some of the people on the Joint Staff who used to work for me, any one of the generals called me in. He said, “Sir, you’ve got to come in and talk to me a second.” I said, “Well, you’re too busy.” He said, “No, no.” He says, “We’ve made the decision we’re going to war with Iraq.” This was on or about the 20th of September. I said, “We’re going to war with Iraq? Why?” He said, “I don’t know.” He said, “I guess they don’t know what else to do.” So I said, “Well, did they find some information connecting Saddam to al-Qaeda?” He said, “No, no.” He says, “There’s nothing new that way. They just made the decision to go to war with Iraq.” He said, “I guess it’s like we don’t know what to do about terrorists, but we’ve got a good military and we can take down governments.” And he said, “I guess if the only tool you have is a hammer, every problem has to look like a nail.

So I came back to see him a few weeks later, and by that time we were bombing in Afghanistan. I said, “Are we still going to war with Iraq?” And he said, “Oh, it’s worse than that.” He reached over on his desk. He picked up a piece of paper. And he said, “I just got this down from upstairs” - meaning the Secretary of Defense’s office - “today.” And he said, “This is a memo that describes how we’re going to take out seven countries in five years, starting with Iraq, and then Syria, Lebanon, Libya, Somalia, Sudan and, finishing off, Iran.” I said, “Is it classified?” He said, “Yes, sir.” I said, “Well, don’t show it to me.” And I saw him a year or so ago, and I said, “You remember that?” He said, “Sir, I didn’t show you that memo! I didn’t show it to you!”

<http://www.cadmusjournal.org/article/issue-6/arms-trade-treaty-opens-new-possibilities-u>

<http://eruditio.worldacademy.org/issue-6/article/remember-your-humanity>

<http://www.informationclearinghouse.info/article42568.htm>

<https://firstlook.org/theintercept/2014/09/23/nobel-peace-prize-fact-day-syria-7th-country-bombed-obama/>

<http://www.informationclearinghouse.info/article42577.htm>

<http://www.informationclearinghouse.info/article42580.htm>

<http://human-wrongs-watch.net/2015/08/06/us-unleashing-of-atomic-weapons-against-civilian-populations-was-a-criminal-act-of-the-first-order/>

<http://human-wrongs-watch.net/2015/08/06/hiroshima-and-nagasaki-remembering-the-power-of-peace/>

<http://human-wrongs-watch.net/2015/08/04/atomic-bombing-hear-the-story-setsuko-thurlow/>

<http://human-wrongs-watch.net/2015/08/04/atomic-bombing-hear-the-story-yasuaki-yamashita/>

<http://human-wrongs-watch.net/2015/08/03/why-nuclear-weapons/>

¹²<https://genius.com/General-wesley-clark-seven-countries-in-five-years-annotated>



Figure 3.27: General Wesley Clark

The global trade in light arms

An important poverty-generating factor in the developing countries is war - often civil war. The five permanent members of the U.N. Security Council are, ironically, the five largest exporters of small arms. Small arms have a long life. The weapons poured into Africa by both sides during the Cold War are still there, and they contribute to political chaos and civil wars that block development and cause enormous human suffering.

The United Nations website on Peace and Security through Disarmament states that “Small arms and light weapons destabilize regions; spark, fuel and prolong conflicts; obstruct relief programmes; undermine peace initiatives; exacerbate human rights abuses; hamper development; and foster a ‘culture of violence’.”

An estimated 639 million small arms and light weapons are in circulation worldwide, one for every ten people. Approximately 300,000 people are killed every year by these weapons, many of them women and children.

Examples of endemic conflict

In several regions of Africa, long-lasting conflicts have prevented development and caused enormous human misery. These regions include Ethiopia, Eritria, Somalia (Darfur), Chad, Zimbabwe and the Democratic Republic of Congo. In the Congo, the death toll reached 5.4 million in 2008, with most of the victims dying of disease and starvation, but with war

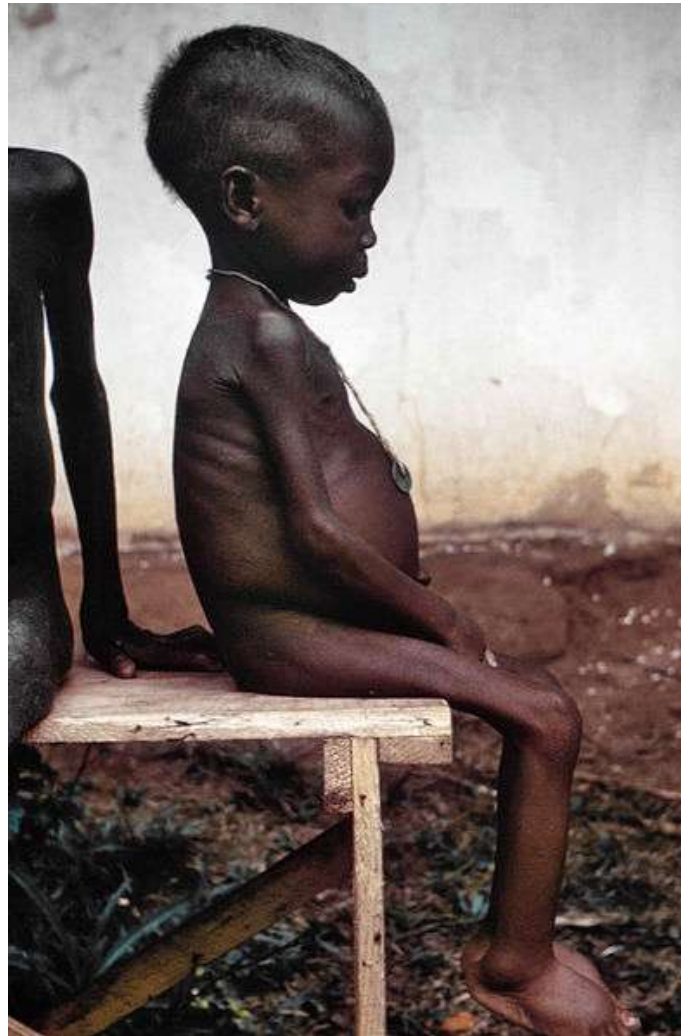

Figure 3.28: 40,000 children die each day from starvation or from poverty-related diseases. Meanwhile, the world spends more than \$1,700,000,000,000 each year on armaments.

as the root cause. In view of these statistics, the international community can be seen to have a strong responsibility to stop supplying small arms and ammunition to regions of conflict. There is absolutely no excuse for the large-scale manufacture and international sale of small arms that exists today.

The Wolfowitz Doctrine

The Wolfowitz Doctrine is the unofficial name given to the early version of the Defense Strategy for the 1990s: The Regional Defense Strategy report for the 1994-99 fiscal years. It was later released by then Secretary of Defense Dick Cheney in 1993. It brazenly advocates that America do everything in its power to retain its global hegemony and superpower status, including ensuring that Russia, China, Iran and other regional powers - but especially Russia - be prevented from attaining enough power to seriously challenge the US. In short, it's another US blueprint for total global supremacy.

There are many quotable passages from the Wolfowitz Doctrine. Here's one which sums up its aims:

“Our first objective is to prevent the re-emergence of a new rival, either on the territory of the former Soviet Union or elsewhere that poses a threat on the order of that posed formerly by the Soviet Union. This is a dominant consideration underlying the new regional defense strategy and requires that we endeavor to prevent any hostile power from dominating a region whose resources would, under consolidated control, be sufficient to generate global power. These regions include Western Europe, East Asia, the territory of the former Soviet Union, and Southwest Asia.”

Similar motives guide US policy today. In February, 2018, US Secretary of Defense James Mattis said: “We will continue to prosecute the campaign against terrorists, but great-power competition - not terrorism - is now the primary focus of US national security.”

Militarism in North Korea

The following states are now believed to currently possess nuclear weapons: The United States, Russia, The United Kingdom, France, China, India, Pakistan, North Korea and Israel. The way in which North Korea obtained its nuclear weapons is described by Wikipedia in the following paragraphs:

“The nuclear program can be traced back to about 1962, when North Korea committed itself to what it called ‘all-fortressization’, which was the beginning of the hyper-militarized North Korea of today. In 1963, North Korea asked the Soviet Union for help in developing nuclear weapons, but was refused. The Soviet Union agreed to help North Korea develop a peaceful nuclear energy program, including the training of nuclear scientists. Later, China, after its nuclear tests, similarly rejected North Korean requests for help with developing nuclear weapons.

“Soviet engineers took part in the construction of the Yongbyon Nuclear Scientific Research Center and began construction of an IRT-2000 research reactor in 1963, which

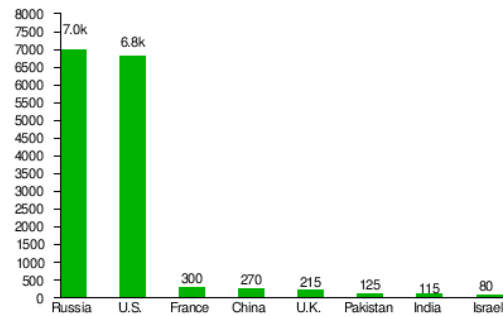

Figure 3.29: Countries by estimated nuclear warhead stockpiles according to the Federation of American scientists.



Figure 3.30: North Korea's dictator, Kim Jong-un. The doctrine of nuclear deterrence rests on the assumption that political leaders will always act rationally, an assumption that seems very uncertain in the case of the U.S.-North Korean conflict.

became operational in 1965 and was upgraded to 8 MW in 1974. In 1979 North Korea indigenously began to build in Yongbyon a second research reactor, an ore processing plant and a fuel rod fabrication plant. Soviet engineers took part in the construction of the Yongbyon Nuclear Scientific Research Center, and began construction of an IRT-2000 research reactor in 1963, which became operational in 1965 and was upgraded to 8 MW in 1974. In 1979 North Korea indigenously began to build in Yongbyon a second research reactor, an ore processing plant and a fuel rod fabrication plant. ”

Thus like other new nuclear weapons states, North Korea obtained nuclear weapons by misuse of nuclear power generation facilities donated by other countries. In addition, North Korea spend a large fraction of its GDP on conventional armaments. Under the Songun policy, the Korean Peoples Army is the central institution of North Korean society. As of 2016, the Korean Peoples Army had 5,889,000 paramilitary personelle (25% of the population of North Korea) making it the largest paramilitary organization on earth.

Table 3.1: SIPRI Military Expenditure Database, 2016

Rank	Country	Annual Spending \$ Bn.	% of GDP
1	United State	611.2	3.3
2	China	215.7	1.9
3	Russia	69.2	5.3
4	Saudi Arabia	63.7	10
5	India	55.9	2.5
6	France	55.7	2.3
7	United Kingdom	48.3	1.9
8	Japan	46.1	1.0
9	Germany	41.1	1.2
10	South Korea	36.8	2.7
11	Italy	27.9	1.5
12	Australia	24.3	2.0

Table 3.2: SIPRI List of arms manufacturers, 2016

Rank	Company	Country	Annual Arms Sales \$ Mn.
1	Lockheed Martin	United States	40,830
2	Boeing	United States	29,510
3	Raytheon	United States	22,910
4	BAE Systems	United Kingdom	22,700
5	Northrop Grumman	United States	21,400
6	General Dynamics	United States	19,230
7	Airbus	European Union	12,520
8	L-3 Communications	United States	8,890
9	Leonardo-Finmeccanica	Italy	8,500
10	Thales Group	France	8,170
11	United Technologies Corporation	United States	6,870
12	Huntington Ingalls Industries	United States	6,720

The SIPRI Yearbook, 2017

Dan Smith of the Stockholm International Peace Research Institute (SIPRI) wrote the following Introduction to the organization's yearbook for 2017:

“An overall perspective on 2016 finds a balance between negative developments and the continued functioning of the international system. However, the year ended with clear grounds for concern that the balance sheet seemed to be tipping towards the negative amid growing unease about the durability of key parts of the international security architecture.

“Conflicts in the Middle East continued to generate humanitarian tragedies and large-scale movement of refugees, and violent conflict continued in several other parts of the world, most notably Africa, Asia and to a lesser extent Eastern Europe. Developments in North Korea's nuclear programme contributed to international political instability with potentially serious knock-on effects. On the positive side, the 2015 Paris Climate Agreement entered into force in November 2016, the 2015 Iran nuclear deal began implementation in time in early 2016 and the United Nations General Assembly adopted a resolution to start negotiations in 2017 on eliminating nuclear weapons. Progress was also made on work to monitor the unfolding implementation of the UN's Agenda 2030 for international social and economic development. A major contribution to the positive side of the balance sheet in 2016 was the peace agreement in Colombia.

“Nonetheless, virtually all the major global indicators for peace and security have moved in a negative direction: more military spending, increased arms trading, more violent conflicts and the continuing forward march of military technology.

“Existing multilateral and bilateral arms control agreements and processes are also under challenge—not least due to the deteriorating relationship between Russia and the United States—raising questions of global concern and potentially epochal scope. Were the great gains in peaceful relations since the end of the cold war now being reversed? Would the return of strategic competition between the major powers have negative implications for managing increased conflict risk? These uncertainties, combined with political developments in Europe and the USA—especially the vote by the United Kingdom to leave the European Union and the election of Donald J. Trump as US President—seemed to reveal a much decreased commitment to international institutions and a renewed emphasis in several key states on a narrowly defined national interest.

“The scale of the challenges facing humanity has been summed up in the proposal to adopt the label of ‘the Anthropocene’ for the current era, thus designating it as one in which human activity is the dominant influence on climate and the environment. It is disconcerting to note that such cooperation risks becoming more elusive than it has seemed for most of the time since the end of the cold war, at a time when it is more needed than ever. Experience has shown that international cooperation can work. But is the international cooperative urge as persistent as the problems it needs to address?”



Figure 3.31: Tom Cruise in “Top Gun”.



Figure 3.32: A culture of violence supports the Devil’s Dynamo.

3.16 A culture of violence

Links with the entertainment industry

Here are a few films that glorify war:

- Black Hawk Down
- Top Gun
- Behind Enemy Lines
- Red Dawn (1984)
- American Sniper
- Iron Eagle
- Pearl Harbor

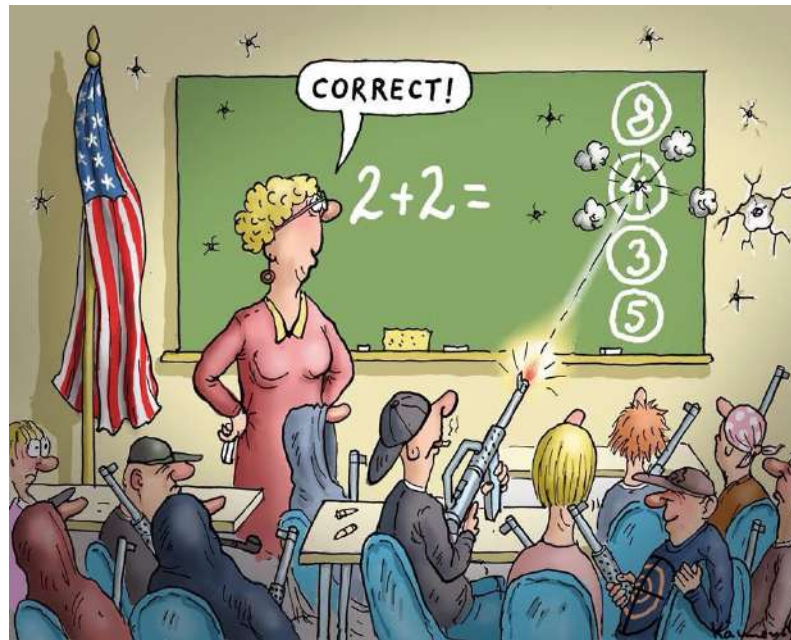

Figure 3.33: **A culture of violence:** In the United States the National Rifle Association has proposed guns in schools as the answer to the epidemic of school shootings.

- Act of Valor
- We Were Soldiers
- The Green Berets

Making a game of killing

The mass media are an important part of our educational system. Perhaps it is time to look more closely at the values that they are transmitting. In particular, we should perhaps look at computer games designed for young boys. They often give the strongest imaginable support to a culture of violence.

For example, a game entitled “Full Spectrum Warrior” was recently reviewed in a Danish newspaper. According to the reviewer, “...An almost perfect combination of graphics, sound, band design, and gameplay makes it seem exactly like the film *Black Hawk Down* - with the player as the main character. This is not just a coincidence, because the game is based on an army training program... Full Spectrum Warrior is an extremely intense experience, and despite the advanced possibilities, the controls are simple enough so that young children can play it... The player is completely drawn into the screen, and remains there until the end of the mission.” The reviewer gave the game six stars (the maximum).

Another genre of computer games has to do with building empires, ignoring the fact that imperialism is morally indefensible. For example, “Forge of Empires” is a browser-based strategy game. It is described as follows: “The game offers a single-player campaign

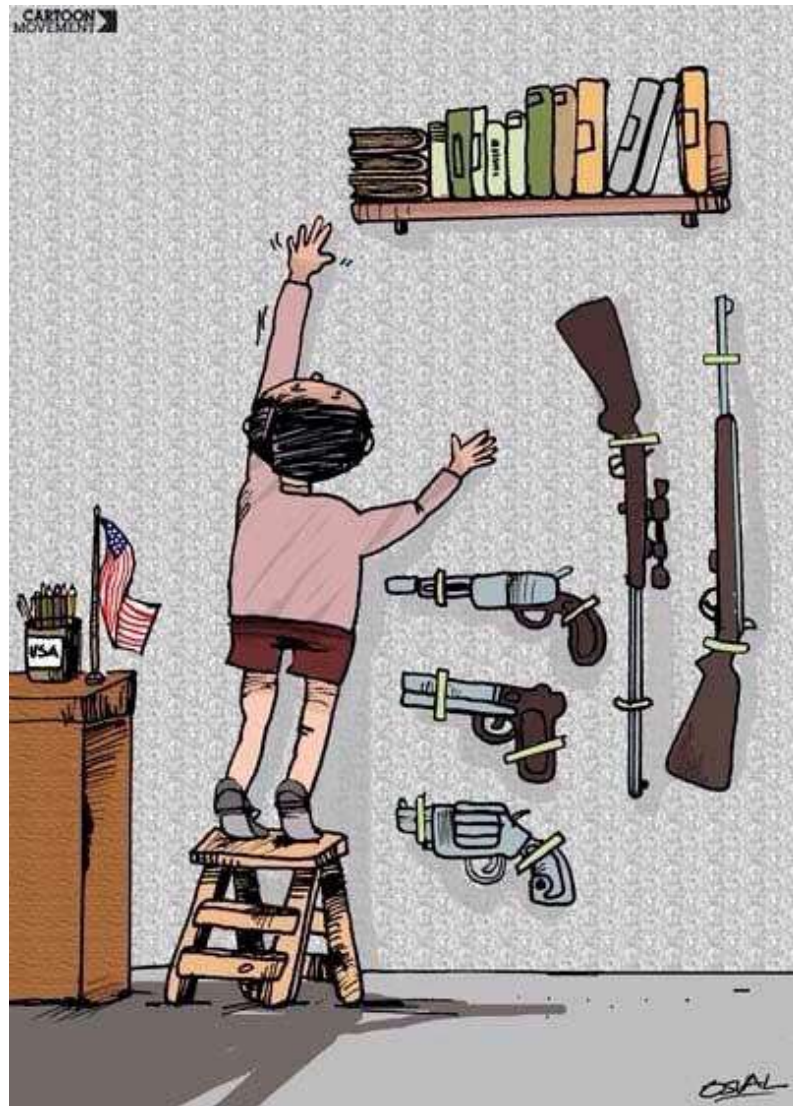

Figure 3.34: A culture of violence. Guns in schools?

for players to explore and conquer several provinces, gaining resources and new technology as they progress.” Conquering countries for the sake of gaining their resources is an all-too-familiar feature of the modern world. In the game “Forge of Empires”, our young people are indoctrinated with the ethos of resource wars.

During his trial, the Norwegian mass-murderer Anders Behring Breivik described how he trained for his attack on young people on the Island of Utöya using the computer game “Call of Duty: Modern Warfare”. The court also heard how he took what he called a “sabbatical” for a year between the summers of 2006 and 2007. During this year, he played a game called “World of Warcraft” full-time, in the bedroom of his mother’s Oslo flat, spending up to 16 hours a day using the game to distance himself from the human and moral significance of killing.

Is this not similar to the frame of mind of drone operators, sitting in comfort in their Nevada bunkers, distanced from the reality of killing? They are playing a computer game that kills targeted individuals and their families, in remote countries, by remote control. There is no need to look into the eyes of the victims. They are just abstract symbols in a computer game.

3.17 The threats and costs of war

In the long run, because of the enormously destructive weapons, which have been produced through the misuse of science, the survival of civilization can only be insured if we are able to abolish the institution of war.

Modern warfare has become prohibitively dangerous and destructive because of the enormously powerful weapons that scientists and engineers have developed. The institution of war could not continue without their cooperation. Thus, scientists and engineers throughout the world have a special responsibility.

Wars are driven by the collective paranoia of voters, who are willing to allow colossal sums to be spent by ‘Defense Departments’. But are civilians really defended? Absolutely not!

We can see this most clearly if we think of nuclear war. Nations threaten each other with “Mutually Assured Destruction”, which has the very appropriate acronym MAD. What does this mean? Does it mean that civilians are being protected? Not at all. Instead they are threatened with complete destruction. Civilians here play the role of hostages in the power games of their leaders. Those leaders’ goal is not protection of ordinary people, but rather protection of the gargantuan profits of the military-industrial complex. As the Indian writer Arundhati Roy put it, “Once weapons were manufactured to fight wars. Now wars are manufactured to sell weapons.”

If a thermonuclear war occurs, it will be the end of human civilization and much of the biosphere. This will definitely happen in the future unless the world rids itself of nuclear weapons, since, in the long run, the finite chance of accidental nuclear war happening due to a technical or human failure during a given year will gradually build up into a certainty of disaster. Scientists and engineers must not sell their knowledge and talents to this march



Figure 3.35: **Children born with birth defects due to the US use of Agent Orange during the Vietnam War. Source: stopwarcoalition.org**

towards the precipice.

The direct and indirect costs of war

The costs of war, both direct and indirect, are so enormous that they are almost beyond comprehension. We face a direct threat because a thermonuclear war may destroy human civilization and much of the biosphere, and an indirect threat because the institution of war interferes seriously with the use of tax money for constructive and peaceful purposes.

Today, despite the end of the Cold War, the world spends roughly 1.7 trillion (i.e. 1.7 million million) US dollars each year on armaments. This colossal flood of money could have been used instead for education, famine relief, development of infrastructure, or on urgently needed public health measures.

The World Health Organization lacks funds to carry through an antimalarial program on as large a scale as would be desirable, but the entire program could be financed for less than our military establishments spend in a single day. Five hours of world arms spending is equivalent to the total cost of the 20-year WHO campaign that resulted in the eradication of smallpox. For every 100,000 people in the world, there are 556 soldiers, but only 85 doctors. Every soldier costs an average of \$20,000 per year, while the average spent on education is only \$380 per school-aged child. With a diversion of funds consumed by three weeks of military spending, the world could create a sanitary water supply for all its people, thus eliminating the cause of almost half of all human illness.

A new drug-resistant form of tuberculosis has recently become widespread in Asia and in the former Soviet Union. In order to combat this new and highly dangerous form of tuberculosis and to prevent its spread, WHO needs \$500 million, an amount equivalent to 1.2 hours of world arms spending.

Today's world is one in which roughly ten million children die every year from starvation or from diseases related to poverty. Besides this enormous waste of young lives through malnutrition and preventable disease, there is a huge waste of opportunities through inadequate education. The rate of illiteracy in the 25 least developed countries is 80%, and the total number of illiterates in the world is estimated to be 800 million. Meanwhile every 60 seconds the world spends \$6.5 million on armaments.



Figure 3.36: A little girl cries as medics attend to her injuries at al-Shifa hospital in Gaza in 2014, during the conflict. Photo: UNICEF/Eyad El Baba

It is plain that if the almost unbelievable sums now wasted on the institution of war were used constructively, most of the pressing problems of humanity could be solved, but today the world spends more than 20 times as much on war as it does on development.

Medical and psychological consequences; loss of life

While in earlier epochs it may have been possible to confine the effects of war mainly to combatants, in the 20th century the victims of war were increasingly civilians, and especially children. For example, according to Quincy Wright's statistics, the First and Second World Wars cost the lives of 26 million soldiers, but the toll in civilian lives was much larger: 64 million.

Since the Second World War, despite the best efforts of the UN, there have been over 150 armed conflicts; and, if civil wars are included, there are on any given day an average of 12 wars somewhere in the world. In the conflicts in Indo-China, the proportion of civilian victims was between 80% and 90%, while in the Lebanese civil war some sources state that the proportion of civilian casualties was as high as 97%.

Civilian casualties often occur through malnutrition and through diseases that would be preventable in normal circumstances. Because of the social disruption caused by war, normal supplies of food, safe water and medicine are interrupted, so that populations become vulnerable to famine and epidemics.¹³

¹³<http://www.cadmusjournal.org/article/volume-2/issue-2-part-3/lessons-world-war-i>
<http://www.truth-out.org/opinion/item/27201-the-leading-terrorist-state>



Figure 3.37: Asylum-seekers in a holding centre on Greece's Samos Island.

Effects of war on children

According to UNICEF figures, 90% of the casualties of recent wars have been civilians, and 50% children. The organization estimates that in recent years, violent conflicts have driven 20 million children from their homes. They have become refugees or internally displaced persons within their own countries.

During the last decade 2 million children have been killed and 6 million seriously injured or permanently disabled as the result of armed conflicts, while 1 million children have been orphaned or separated from their families. Of the ten countries with the highest rates of death of children under five years of age, seven are affected by armed conflicts. UNICEF estimates that 300,000 child soldiers are currently forced to fight in 30 armed conflicts throughout the world. Many of these have been forcibly recruited or abducted.

Even when they are not killed or wounded by conflicts, children often experience painful psychological traumas: the violent death of parents or close relatives, separation from their families, seeing family members tortured, displacement from home, disruption of ordinary life, exposure to shelling and other forms of combat, starvation and anxiety about the future.¹⁴

Refugees

Human Rights Watch estimates that in 2001 there were 15 million refugees in the world, forced from their countries by war, civil and political conflict, or by gross violations of human rights. In addition, there were an estimated 22 million internally displaced persons, violently forced from their homes but still within the borders of their countries.

In 2001, 78% of all refugees came from ten areas: Afghanistan, Angola, Burma, Burundi, Congo-Kinshasa, Eritrea, Iraq, the Palestinian territories, Somalia and Sudan. A

¹⁴<http://www.ncbi.nlm.nih.gov/pmc/articles/PMC2080482/>

quarter of all refugees are Palestinians, who make up the world's oldest and largest refugee population. 45% of the world's refugees have found sanctuaries in Asia, 30% in Africa, 19% in Europe and 5% in North America.

Refugees who have crossed an international border are in principle protected by Article 14 of the Universal Declaration of Human Rights, which affirms their right "to seek and to enjoy in other countries asylum from persecution". In 1950 the Office of the High Commissioner for Refugees was created to implement Article 14, and in 1951 the Convention Relating to the Status of Refugees was adopted by the UN. By 2002 this legally binding treaty had been signed by 140 nations. However the industrialized countries have recently adopted a very hostile and restrictive attitude towards refugees, subjecting them to arbitrary arrests, denial of social and economic rights, and even forcible return to countries in which they face persecution.

The status of internally displaced persons is even worse than that of refugees who have crossed international borders. In many cases the international community simply ignores their suffering, reluctant to interfere in the internal affairs of sovereign states. In fact, the United Nations Charter is self-contradictory in this respect, since on the one hand it calls for non-interference in the internal affairs of sovereign states, but on the other hand, people everywhere are guaranteed freedom from persecution by the Charter's Universal Declaration of Human Rights.¹⁵

Damage to infrastructure

Most insurance policies have clauses written in fine print exempting companies from payment of damage caused by war. The reason for this is simple. The damage caused by war is so enormous that insurance companies could never come near to paying for it without going bankrupt.

We mentioned above that the world spends 1.7 trillion dollars each year on preparations for war. A similarly colossal amount is needed to repair the damage to infrastructure caused by war. Sometimes this damage is unintended, but sometimes it is intentional.

During World War II, one of the main aims of air attacks by both sides was to destroy the industrial infrastructure of the opponent. This made some sense in a war expected to last several years, because the aim was to prevent the enemy from producing more munitions. However, during the Gulf War of 1990, the infrastructure of Iraq was attacked, even though the war was expected to be short. Electrical generating plants and water purification facilities were deliberately destroyed with the apparent aim of obtaining leverage over Iraq after the war.

In general, because war has such a catastrophic effect on infrastructure, it can be thought of as the opposite of development. War is the greatest generator of poverty.¹⁶

¹⁵<https://www.hrw.org/topic/refugees>

¹⁶<https://www.wsws.org/en/articles/2002/11/iraq-n04.html>
<http://www.globalresearch.ca/charges-against-humanity-the-destruction-of-iraqs-electricity-infrastructure-the-social-economic-and-environmental-impacts/5355665>
<http://www.afdb.org/fileadmin/uploads/afdb/Documents/Publications/00157630-EN-ERP-48.PDF>



Figure 3.38: Image source: Greenpeace

Ecological damage

Warfare during the 20th century has not only caused the loss of 175 million lives (primarily civilians) - it has also caused the greatest ecological catastrophes in human history. The damage takes place even in times of peace. Studies by Joni Seager, a geographer at the University of Vermont, conclude that “a military presence anywhere in the world is the single most reliable predictor of ecological damage”.

Modern warfare destroys environments to such a degree that it has been described as an “environmental holocaust.” For example, herbicides use in the Vietnam War killed an estimated 6.2 billion board-feet of hardwood trees in the forests north and west of Saigon, according to the American Association for the Advancement of Science. Herbicides such as Agent Orange also made enormous areas of previously fertile land unsuitable for agriculture for many years to come. In Vietnam and elsewhere in the world, valuable agricultural land has also been lost because land mines or the remains of cluster bombs make it too dangerous for farming.

During the Gulf War of 1990, the oil spills amounted to 150 million barrels, 650 times the amount released into the environment by the notorious Exxon Valdez disaster. During the Gulf War an enormous number of shells made of depleted uranium were fired. When the dust produced by exploded shells is inhaled it often produces cancer, and it will remain in the environment of Iraq for decades.

Radioactive fallout from nuclear tests pollutes the global environment and causes many thousands of cases of cancer, as well as birth abnormalities. Most nuclear tests have been carried out on lands belonging to indigenous peoples. Agent Orange also produced cancer, birth abnormalities and other serious forms of illness both in the Vietnamese population and among the foreign soldiers fighting in Vietnam¹⁷

¹⁷<http://www.dailymail.co.uk/news/article-2401378/Agent-Orange-Vietnamese-children-suffering-effects-herbicide-sprayed-US-Army-40-years-ago.html>



Figure 3.39: The 15 megaton explosion detonated by the United States at Bikini Atoll in 1954 produced lasting biological damage to humans and animals living on the distant Marshall Islands. Today, half a century later, the islanders still experience radiation sickness in the form of leukemia and birth defects. Source: www.theguardian.com

3.18 The threat of nuclear war

As bad as conventional arms and conventional weapons may be, it is the possibility of a catastrophic nuclear war that poses the greatest threat to humanity. There are today roughly 16,000 nuclear warheads in the world. The total explosive power of the warheads that exist or that could be made on short notice is approximately equal to 500,000 Hiroshima bombs.

To multiply the tragedy of Hiroshima by a factor of half a million makes an enormous difference, not only quantitatively, but also qualitatively. Those who have studied the question believe that a nuclear catastrophe today would inflict irreversible damage on our civilization, genetic pool and environment.

Thermonuclear weapons consist of an inner core where the fission of uranium-235 or plutonium takes place. The fission reaction in the core is able to start a fusion reaction in the next layer, which contains isotopes of hydrogen. It is possible to add a casing of ordinary uranium outside the hydrogen layer, and under the extreme conditions produced by the fusion reaction, this ordinary uranium can undergo fission. In this way, a fission-fusion-fission bomb of almost limitless power can be produced.

For a victim of severe radiation exposure, the symptoms during the first week are nausea, vomiting, fever, apathy, delirium, diarrhoea, oropharyngeal lesions and leukopenia. Death occurs during the first or second week.

We can perhaps be helped to imagine what a nuclear catastrophe means in human terms by reading the words of a young university professor, who was 2,500 meters from the hypocenter at the time of the bombing of Hiroshima: "Everything I saw made a deep impression: a park nearby covered with dead bodies... very badly injured people evacuated

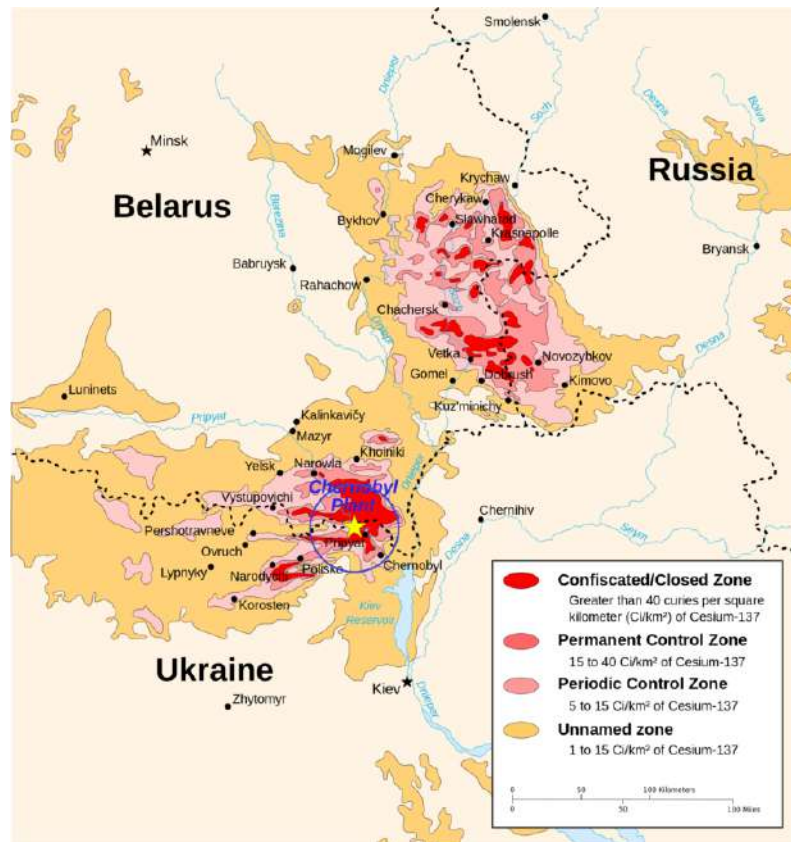

Figure 3.40: A nuclear war would be an ecological disaster, making large portions of the world permanently uninhabitable because of long-lasting radioactivity. Chernobyl radiation map 1996 30km zone by CIA Factbook. Licensed under CC BY-SA 2.5 via Wikimedia Commons.

in my direction... Perhaps most impressive were girls, very young girls, not only with their clothes torn off, but their skin peeled off as well. ... My immediate thought was that this was like the hell I had always read about. ... I had never seen anything which resembled it before, but I thought that should there be a hell, this was it.”

One argument that has been used in favor of nuclear weapons is that no sane political leader would employ them. However, the concept of deterrence ignores the possibility of war by accident or miscalculation, a danger that has been increased by nuclear proliferation and by the use of computers with very quick reaction times to control weapons systems.

Recent nuclear power plant accidents remind us that accidents frequently happen through human and technical failure, even for systems which are considered to be very “safe.” We must also remember the time scale of the problem. To assure the future of humanity, nuclear catastrophe must be avoided year after year and decade after decade. In the long run, the safety of civilization cannot be achieved except by the abolition of nuclear weapons, and ultimately the abolition of the institution of war.

In 1985, International Physicians for the Prevention of Nuclear War received the Nobel



Figure 3.41: Sculpture depicting Saint George slaying the dragon. The dragon is created from fragments of Soviet SS-20 and United States Pershing nuclear missiles. UN Photo/Milton Grant

Peace Prize. IPPNW had been founded in 1980 by six physicians, three from the Soviet Union and three from the United States. Today, the organization has wide membership among the world's physicians. Professor Bernard Lowen of the Harvard School of Public Health, one of the founders of IPPNW, said in a recent speech:

"...No public health hazard ever faced by humankind equals the threat of nuclear war. Never before has man possessed the destructive resources to make this planet uninhabitable... Modern medicine has nothing to offer, not even a token benefit, in the event of nuclear war..."

"We are but transient passengers on this planet Earth. It does not belong to us. We are not free to doom generations yet unborn. We are not at liberty to erase humanity's past or dim its future. Social systems do not endure for eternity. Only life can lay claim to uninterrupted continuity. This continuity is sacred."

The danger of a catastrophic nuclear war casts a dark shadow over the future of our species. It also casts a very black shadow over the future of the global environment. The environmental consequences of a massive exchange of nuclear weapons have been treated in a number of studies by meteorologists and other experts from both East and West. They predict that a large-scale use of nuclear weapons would result in fire storms with very high winds and high temperatures, which would burn a large proportion of the wild land fuels in the affected nations. The resulting smoke and dust would block out sunlight for a period of many months, at first only in the northern hemisphere but later also in the southern hemisphere.

Temperatures in many places would fall far below freezing, and much of the earth's plant life would be killed. Animals and humans would then die of starvation. The nuclear winter effect was first discovered as a result of the Mariner 9 spacecraft exploration of Mars in 1971. The spacecraft arrived in the middle of an enormous dust-storm on Mars, and measured a large temperature drop at the surface of the planet, accompanied by a heating of the upper atmosphere. These measurements allowed scientists to check their

theoretical models for predicting the effect of dust and other pollutants distributed in planetary atmospheres.

Using experience gained from the studies of Mars, R.P. Turco, O.B. Toon, T. Ackerman, J.B. Pollack and C. Sagan made a computer study of the climatic effects of the smoke and dust that would result from a large-scale nuclear war. This early research project is sometimes called the TTAPS Study, after the initials of the authors.

In April 1983, a special meeting was held in Cambridge, Massachusetts, where the results of the TTAPS Study and other independent studies of the nuclear winter effect were discussed by more than 100 experts. Their conclusions were presented at a forum in Washington, D.C., the following December, under the chairmanship of U.S. Senators Kennedy and Hatfield. The numerous independent studies of the nuclear winter effect all agreed of the following main predictions:

High-yield nuclear weapons exploded near the earth's surface would put large amounts of dust into the upper atmosphere. Nuclear weapons exploded over cities, forests, oilfields and refineries would produce fire storms of the type experienced in Dresden and Hamburg after incendiary bombings during the Second World War. The combination of high-altitude dust and lower altitude soot would prevent sunlight from reaching the earth's surface, and the degree of obscuration would be extremely high for a wide range of scenarios.

A baseline scenario used by the TTAPS study assumes a 5,000-megaton nuclear exchange, but the threshold for triggering the nuclear winter effect is believed to be much lower than that. After such an exchange, the screening effect of pollutants in the atmosphere might be so great that, in the northern and middle latitudes, the sunlight reaching the earth would be only 1% of ordinary sunlight on a clear day, and this effect would persist for many months. As a result, the upper layers in the atmosphere might rise in temperature by as much as 100 °C, while the surface temperatures would fall, perhaps by as much a 50 °C.

The temperature inversion produced in this way would lead to superstability, a condition in which the normal mixing of atmospheric layers is suppressed. The hydrological cycle (which normally takes moist air from the oceans to a higher and cooler level, where the moisture condenses as rain) would be strongly suppressed. Severe droughts would thus take place over continental land masses. The normal cleansing action of rain would be absent in the atmosphere, an effect which would prolong the nuclear winter.

In the northern hemisphere, forests would die because of lack of sunlight, extreme cold, and drought. Although the temperature drop in the southern hemisphere would be less severe, it might still be sufficient to kill a large portion of the tropical forests, which normally help to renew the earth's oxygen.

The oxygen content of the atmosphere would then fall dangerously, while the concentration of carbon dioxide and oxides of nitrogen produced by firestorms would remain high. The oxides of nitrogen would ultimately diffuse to the upper atmosphere, where they would destroy the ozone layer.

Thus, even when the sunlight returned after an absence of many months, it would be sunlight containing a large proportion of the ultraviolet frequencies which are normally absorbed by the ozone in the stratosphere, and therefore a type of light dangerous to life.

Finally, after being so severely disturbed, there is no guarantee that the global climate would return to its normal equilibrium.

Even a nuclear war below the threshold of nuclear winter might have climatic effects very damaging to human life. Professor Paul Ehrlich, of Stanford University, has expressed this in the following words:

“...A smaller war, which set off fewer fires and put less dust into the atmosphere, could easily depress temperatures enough to essentially cancel grain production in the northern hemisphere. That in itself would be the greatest catastrophe ever delivered upon Homo Sapiens, just that one thing, not worrying about prompt effects. Thus even below the threshold, one cannot think of survival of a nuclear war as just being able to stand up after the bomb has gone off.”¹⁸

3.19 Flaws in the concept of nuclear deterrence

Before discussing other defects in the concept of deterrence, it must be said very clearly that the idea of “massive nuclear retaliation” is completely unacceptable from an ethical point of view. The doctrine of retaliation, performed on a massive scale, violates not only

¹⁸<http://www.voanews.com/content/pope-francis-calls-for-nuclear-weapons-ban/2909357.html>
<http://www.cadmusjournal.org/article/issue-4/flaws-concept-nuclear-deterrance>
<http://www.countercurrents.org/avery300713.htm>
<https://www.wagingpeace.org/author/john-avery/>
<http://www.commondreams.org/news/2015/08/06/70-years-after-bombing-hiroshima-calls-abolish-nuclear-weapons>
<http://www.informationclearinghouse.info/article42488.htm>
<http://www.informationclearinghouse.info/article42492.htm>
<http://www.commondreams.org/views/2015/08/06/hiroshima-and-nagasaki-remembering-power>
<http://human-wrongs-watch.net/2015/07/22/israel-iran-and-the-nuclear-non-proliferation-treaty/>
<http://human-wrongs-watch.net/2015/06/25/militarisms-hostages/>
<http://human-wrongs-watch.net/2015/05/24/the-path-to-zero-dialogues-on-nuclear-dangers-by-richard-falk-and-david-krieger/>
<http://human-wrongs-watch.net/2015/03/30/europe-must-not-be-forced-into-a-nuclear-war-with-russia/>
<http://www.truth-out.org/opinion/item/32073-the-us-should-eliminate-its-nuclear-arsenal-not-modernize-it>
<http://www.cadmusjournal.org/article/issue-4/flaws-concept-nuclear-deterrance>
<http://www.cadmusjournal.org/article/issue-6/arms-trade-treaty-opens-new-possibilities-u>
<http://eruditio.worldacademy.org/issue-6/article/remember-your-humanity>
<http://www.informationclearinghouse.info/article42568.htm>
<https://firstlook.org/theintercept/2014/09/23/nobel-peace-prize-fact-day-syria-7th-country-bombed-obama/>
<http://www.informationclearinghouse.info/article42577.htm>
<http://www.informationclearinghouse.info/article42580.htm>
<http://human-wrongs-watch.net/2015/08/06/us-unleashing-of-atomic-weapons-against-civilian-populations-was-a-criminal-act-of-the-first-order/>
<http://human-wrongs-watch.net/2015/08/06/hiroshima-and-nagasaki-remembering-the-power-of-peace/>
<http://human-wrongs-watch.net/2015/08/04/atomic-bombing-hear-the-story-setsuko-thurlow/>
<http://human-wrongs-watch.net/2015/08/04/atomic-bombing-hear-the-story-yasuaki-yamashita/>
<http://human-wrongs-watch.net/2015/08/03/why-nuclear-weapons/>

the principles of common human decency and common sense, but also the ethical principles of every major religion. Retaliation is especially contrary to the central commandment of Christianity which tells us to love our neighbor, even if he or she is far away from us, belonging to a different ethnic or political group, and even if our distant neighbor has seriously injured us. This principle has a fundamental place not only in Christianity but also in Buddhism. “Massive retaliation” completely violates these very central ethical principles, which are not only clearly stated and fundamental but also very practical, since they prevent escalatory cycles of revenge and counter-revenge.

Contrast Christian ethics with estimates of the number of deaths that would follow a US nuclear strike against Russia: Several hundred million deaths. These horrifying estimates shock us not only because of the enormous magnitude of the expected mortality, but also because the victims would include people of every kind: women, men, old people, children and infants, completely irrespective of any degree of guilt that they might have. As a result of such an attack, many millions of people in neutral countries would also die. This type of killing has to be classified as genocide.

When a suspected criminal is tried for a wrongdoing, great efforts are devoted to clarifying the question of guilt or innocence. Punishment only follows if guilt can be proved beyond any reasonable doubt. Contrast this with the totally indiscriminate mass slaughter that results from a nuclear attack!

It might be objected that disregard for the guilt or innocence of victims is a universal characteristic of modern war, since statistics show that, with time, a larger and larger percentage of the victims have been civilians, and especially children. For example, the air attacks on Coventry during World War II, or the fire bombings of Dresden and Tokyo, produced massive casualties which involved all segments of the population with complete disregard for the question of guilt or innocence. The answer, I think, is that modern war has become generally unacceptable from an ethical point of view, and this unacceptability is epitomized in nuclear weapons.

The enormous and indiscriminate destruction produced by nuclear weapons formed the background for an historic 1996 decision by the International Court of Justice in the Hague. In response to questions put to it by WHO and the UN General Assembly, the Court ruled that “the threat and use of nuclear weapons would generally be contrary to the rules of international law applicable in armed conflict, and particularly the principles and rules of humanitarian law.” The only *possible* exception to this general rule might be “an extreme circumstance of self-defense, in which the very survival of a state would be at stake”. But the Court refused to say that even in this extreme circumstance the threat or use of nuclear weapons would be legal. It left the exceptional case undecided. In addition, the World Court added unanimously that “there exists an obligation to pursue in good faith *and bring to a conclusion* negotiations leading to nuclear disarmament in all its aspects under strict international control.”

This landmark decision has been criticized by the nuclear weapon states as being decided “by a narrow margin”, but the structuring of the vote made the margin seem more narrow than it actually was. Seven judges voted against Paragraph 2E of the decision (the paragraph which states that the threat or use of nuclear weapons would be generally

illegal, but which mentions as a possible exception the case where a nation might be defending itself from an attack that threatened its very existence.) Seven judges voted for the paragraph, with the President of the Court, Muhammad Bedjaoui of Algeria casting the deciding vote. Thus the Court adopted it, seemingly by a narrow margin. But three of the judges who voted against 2E did so because they believed that no possible exception should be mentioned! Thus, if the vote had been slightly differently structured, the result would have been ten to four.

Of the remaining four judges who cast dissenting votes, three represented nuclear weapons states, while the fourth thought that the Court ought not to have accepted the questions from WHO and the UN. However Judge Schwebel from the United States, who voted against Paragraph 2E, nevertheless added, in a separate opinion, "It cannot be accepted that the use of nuclear weapons on a scale which would - or could - result in the deaths of many millions in indiscriminate inferno and by far-reaching fallout, have pernicious effects in space and time, and render uninhabitable much of the earth, could be lawful." Judge Higgins from the UK, the first woman judge in the history of the Court, had problems with the word "generally" in Paragraph 2E and therefore voted against it, but she thought that a more profound analysis might have led the Court to conclude in favor of illegality in all circumstances. Judge Fleischhauer of Germany said in his separate opinion, "The nuclear weapon is, in many ways, the negation of the humanitarian considerations underlying the law applicable in armed conflict and the principle of neutrality. The nuclear weapon cannot distinguish between civilian and military targets. It causes immeasurable suffering. The radiation released by it is unable to respect the territorial integrity of neutral States."

President Bedjaoui, summarizing the majority opinion, called nuclear weapons "the ultimate evil", and said "By its nature, the nuclear weapon, this blind weapon, destabilizes humanitarian law, the law of discrimination in the use of weapons... The ultimate aim of every action in the field of nuclear arms will always be nuclear disarmament, an aim which is no longer utopian and which all have a duty to pursue more actively than ever."

Thus the concept of nuclear deterrence is not only unacceptable from the standpoint of ethics; it is also contrary to international law. The World Courts 1996 advisory Opinion unquestionably also represents the opinion of the majority of the world's peoples. Although no formal plebiscite has been taken, the votes in numerous resolutions of the UN General Assembly speak very clearly on this question. For example the New Agenda Resolution (53/77Y) was adopted by the General Assembly on 4 December 1998 by a massively affirmative vote, in which only 18 out of the 170 member states voted against the resolution.¹⁹ The New Agenda Resolution proposes numerous practical steps towards complete nuclear disarmament, and it calls on the Nuclear-Weapon States "to demonstrate an unequivocal commitment to the speedy and total elimination of their nuclear weapons and without delay to pursue in good faith and bring to a conclusion negotiations leading to the elimi-

¹⁹Of the 18 countries that voted against the New Agenda resolution, 10 were Eastern European countries hoping for acceptance into NATO, whose votes seem to have been traded for increased probability of acceptance.

nation of these weapons, thereby fulfilling their obligations under Article VI of the Treaty on the Non-Proliferation of Nuclear Weapons (NPT)". Thus, in addition to being ethically unacceptable and contrary to international law, nuclear weapons also contrary to the principles of democracy.

More recently, on 7 July, 2017, the Treaty on the Prohibition of Nuclear Weapons was passed by a massive majority in the General Assembly of the United Nations, It was opposed only by the nuclear weapons states and a few of their allies. The Nuclear Ban Treaty makes it very clear that nuclear weapons are illegal under international law. Although the nuclear weapons states still cling to their world-destroying weapons, it is to be hoped that the force of global public opinion will eventually force them to comply with the law.

Having said these important things, we can now turn to some of the other defects in the concept of nuclear deterrence. One important defect is that nuclear war may occur through accident or miscalculation - through technical defects or human failings. This possibility is made greater by the fact that despite the end of the Cold War, thousands of missiles carrying nuclear warheads are still kept on a "hair-trigger" state of alert with a quasi-automatic reaction time measured in minutes. There is a constant danger that a nuclear war will be triggered by error in evaluating the signal on a radar screen. For example, the BBC reported recently that a group of scientists and military leaders are worried that a small asteroid entering the earth's atmosphere and exploding could trigger a nuclear war if mistaken for a missile strike.

A number of prominent political and military figures (many of whom have ample knowledge of the system of deterrence, having been part of it) have expressed concern about the danger of accidental nuclear war. Colin S. Grey²⁰ expressed this concern as follows: "The problem, indeed the enduring problem, is that we are resting our future upon a nuclear deterrence system concerning which we cannot tolerate even a single malfunction." General Curtis E. LeMay²¹ has written, "In my opinion a general war will grow through a series of political miscalculations and accidents rather than through any deliberate attack by either side." Bruce G. Blair²² has remarked that "It is obvious that the rushed nature of the process, from warning to decision to action, risks causing a catastrophic mistake."... "This system is an accident waiting to happen."

Today, the system that is supposed to give us security is called Mutually Assured Destruction, appropriately abbreviated as MAD. It is based on the idea of deterrence, which maintains that because of the threat of massive retaliation, no sane leader would start a nuclear war.

One important defect in the concept of deterrence is the fact that nuclear war may occur through accident or miscalculation, through technical defects or human failings, or by terrorism. This possibility is made greater by the fact that despite the end of the Cold War, thousands of missiles carrying nuclear warheads are still kept on "hair-trigger alert"

²⁰Chairman, National Institute for Public Policy

²¹Founder and former Commander in Chief of the United States Strategic Air Command

²²Brookings Institute

with a quasi-automatic reaction time measured in minutes. There is a constant danger that a nuclear war will be triggered by error in evaluating the signal on a radar screen.

Incidents in which global disaster is avoided by a hair's breadth are constantly occurring. For example, on the night of 26 September, 1983, Lt. Col. Stanislav Petrov, a young software engineer, was on duty at a surveillance center near Moscow. Suddenly the screen in front of him turned bright red.

An alarm went off. It's enormous piercing sound filled the room. A second alarm followed, and then a third, fourth and fifth. "The computer showed that the Americans had launched a strike against us", Petrov remembered later. His orders were to pass the information up the chain of command to Secretary General Yuri Andropov. Within minutes, a nuclear counterattack would be launched. However, because of certain inconsistent features of the alarm, Petrov disobeyed orders and reported it as a computer error, which indeed it was.

Most of us probably owe our lives to his coolheaded decision and knowledge of software systems. The narrowness of this escape is compounded by the fact that Petrov was on duty only because of the illness of another officer with less knowledge of software, who would have accepted the alarm as real.

Narrow escapes such as this show us clearly that in the long run, the combination of space-age science and stone-age politics will destroy us. We urgently need new political structures and new ethics to match our advanced technology.

3.20 Dangers of nuclear power generation

The Chernobyl disaster

The dangers of nuclear power generation are exemplified by the Chernobyl disaster: On the 26th of April, 1986, during the small hours of the morning, the staff of the Chernobyl nuclear reactor in Ukraine turned off several safety systems in order to perform a test. The result was a core meltdown in Reactor 4, causing a chemical explosion that blew off the reactor's 1,000-ton steel and concrete lid. 190 tons of highly radioactive uranium and graphite were hurled into the atmosphere. The resulting radioactive fallout was 200 times greater than that caused by the nuclear bombs that destroyed Hiroshima and Nagasaki. The radioactive cloud spread over Belarus, Ukraine, Russia, Finland, Sweden and Eastern Europe, exposing the populations of these regions to levels of radiation 100 times the normal background. Ultimately, the radioactive cloud reached as far as Greenland and parts of Asia.

The exact number of casualties resulting from the Chernobyl meltdown is a matter of controversy, but according to a United Nations report, as many as 9 million people have been adversely affected by the disaster. Since 1986, the rate of thyroid cancer in affected areas has increased ten-fold. An area of 155,000 square kilometers (almost half the size of Italy) in Belarus, Ukraine and Russia is still severely contaminated. Even as far away as Wales, hundreds of farms are still under restrictions because of sheep eating radioactive

grass.

Public opinion turned against nuclear power generation as a result of the Chernobyl disaster. Had the disaster taken place in Western Europe or North America, its effect on public opinion would have been still greater. Nevertheless, because of the current energy crisis, and because of worries about global warming, a number of people are arguing that nuclear energy should be given a second chance. The counter-argument is that a large increase in the share of nuclear power in the total spectrum of energy production would have little effect on climate change but it would involve unacceptable dangers, not only dangers of accidents and dangers associated with radioactive waste disposal, but above all, dangers of proliferation of nuclear weapons.

Of the two bombs that destroyed Hiroshima and Nagasaki, one made use of the rare isotope of uranium, U-235, while the other used plutonium. Both of these materials can be made by a nation with a nuclear power generation program.

Reactors and nuclear weapons

Uranium has atomic number 92, i.e., a neutral uranium atom has a nucleus containing 92 positively-charged protons, around which 92 negatively-charged electrons circle. All of the isotopes of uranium have the same number of protons and electrons, and hence the same chemical properties, but they differ in the number of neutrons in their nuclei. For example, the nucleus of U-235 has 143 neutrons, while that of U-238 has 146. Notice that $92+143=235$, while $92+146=238$. The number written after the name of an element to specify a particular isotope is the number of neutrons plus the number of protons. This is called the "nucleon number", and the weight of an isotope is roughly proportional to it. This means that U-238 is slightly heavier than U-235. If the two isotopes are to be separated, difficult physical methods dependent on mass must be used, since their chemical properties are identical. In natural uranium, the amount of the rare isotope U-235 is only 0.7 percent.

A paper published in 1939 by Niels Bohr and John A. Wheeler indicated that it was the rare isotope of uranium, U-235, that undergoes fission. A bomb could be constructed, they pointed out, if enough highly enriched U-235 could be isolated from the more common isotope, U-238. Calculations later performed in England by Otto Frisch and Rudolf Peierls showed that the "critical mass" of highly enriched uranium needed is quite small: only a few kilograms.

The Bohr-Wheeler theory also predicted that an isotope of plutonium, Pu-239, should be just as fissionable as U-235²³. Instead of trying to separate the rare isotope, U-235, from the common isotope, U-238, physicists could just operate a nuclear reactor until a

²³Both U-235 and Pu-239 have odd nucleon numbers. When U-235 absorbs a neutron, it becomes U-236, while when Pu-239 absorbs a neutron it becomes Pu-240. In other words, absorption of a neutron converts both these species to nuclei with even nucleon numbers. According to the Bohr-Wheeler theory, nuclei with even nucleon numbers are especially tightly-bound. Thus absorption of a neutron converts U-235 to a highly-excited state of U-236, while Pu-239 is similarly converted to a highly excited state of Pu-240. The excitation energy distorts the nuclei to such an extent that fission becomes possible.

sufficient amount of Pu-239 accumulated, and then separate it out by ordinary chemical means.

Thus in 1942, when Enrico Fermi and his coworkers at the University of Chicago produced the world's first controlled chain reaction within a pile of cans containing ordinary (nonenriched) uranium powder, separated by blocks of very pure graphite, the chain-reacting pile had a double significance: It represented a new source of energy for mankind, but it also had a sinister meaning. It represented an easy path to nuclear weapons, since one of the by-products of the reaction was a fissionable isotope of plutonium, Pu-239. The bomb dropped on Hiroshima in 1945 used U-235, while the Nagasaki bomb used Pu-239.

By reprocessing spent nuclear fuel rods, using ordinary chemical means, a nation with a power reactor can obtain weapons-usable Pu-239. Even when such reprocessing is performed under international control, the uncertainty as to the amount of Pu-239 obtained is large enough so that the operation might superficially seem to conform to regulations while still supplying enough Pu-239 to make many bombs.

The enrichment of uranium²⁴ is also linked to reactor use. Many reactors of modern design make use of low enriched uranium (LEU) as a fuel. Nations operating such a reactor may claim that they need a program for uranium enrichment in order to produce LEU for fuel rods. However, by operating their ultracentrifuges a little longer, they can easily produce highly enriched uranium (HEU), i.e., uranium containing a high percentage of the rare isotope U-235, and therefore usable in weapons.

Known reserves of uranium are only sufficient for the generation of 8×10^{20} joules of electrical energy²⁵, i.e., about 25 TWy. It is sometimes argued that a larger amount of electricity could be obtained from the same amount of uranium through the use of fast breeder reactors, but this would involve totally unacceptable proliferation risks. In fast breeder reactors, the fuel rods consist of highly enriched uranium. Around the core, is an envelope of natural uranium. The flux of fast neutrons from the core is sufficient to convert a part of the U-238 in the envelope into Pu-239, a fissionable isotope of plutonium.

Fast breeder reactors are prohibitively dangerous from the standpoint of nuclear proliferation because both the highly enriched uranium from the fuel rods and the Pu-239 from the envelope are directly weapons-usable. It would be impossible, from the standpoint of equity, to maintain that some nations have the right to use fast breeder reactors, while others do not. If all nations used fast breeder reactors, the number of nuclear weapons states would increase drastically.

It is interesting to review the way in which Israel, South Africa, Pakistan, India and North Korea²⁶ obtained their nuclear weapons, since in all these cases the weapons were constructed under the guise of "atoms for peace", a phrase that future generations may someday regard as being tragically self-contradictory.

Israel began producing nuclear weapons in the late 1960's (with the help of a "peaceful"

²⁴i.e. production of uranium with a higher percentage of U-235 than is found in natural uranium

²⁵Craig, J.R., Vagn, D.J. and Skinner, B.J., *Resources of the Earth: Origin, Use and Environmental Impact, Third Edition*, page 210.

²⁶Israel, India and Pakistan have refused to sign the Nuclear Non-Proliferation Treaty, and North Korea, after signing the NPT, withdrew from it in 2003.

nuclear reactor provided by France, and with the tacit approval of the United States) and the country is now believed to possess 100-150 of them, including neutron bombs. Israel's policy is one of visibly possessing nuclear weapons while denying their existence.

South Africa, with the help of Israel and France, also weaponized its civil nuclear program, and it tested nuclear weapons in the Indian Ocean in 1979. In 1991 however, South Africa destroyed its nuclear weapons and signed the NPT.

India produced what it described as a "peaceful nuclear explosion" in 1974. By 1989 Indian scientists were making efforts to purify the lithium-6 isotope, a key component of the much more powerful thermonuclear bombs. In 1998, India conducted underground tests of nuclear weapons, and is now believed to have roughly 60 warheads, constructed from Pu-239 produced in "peaceful" reactors.

Pakistan's efforts to obtain nuclear weapons were spurred by India's 1974 "peaceful nuclear explosion". As early as 1970, the laboratory of Dr. Abdul Qadeer Khan, (a metallurgist who was to become Pakistan's leading nuclear bomb maker) had been able to obtain from a Dutch firm the high-speed ultracentrifuges needed for uranium enrichment. With unlimited financial support and freedom from auditing requirements, Dr. Khan purchased restricted items needed for nuclear weapon construction from companies in Europe and the United States. In the process, Dr. Khan became an extremely wealthy man. With additional help from China, Pakistan was ready to test five nuclear weapons in 1998. The Indian and Pakistani nuclear bomb tests, conducted in rapid succession, presented the world with the danger that these devastating weapons would be used in the conflict over Kashmir. Indeed, Pakistan announced that if a war broke out using conventional weapons, Pakistan's nuclear weapons would be used "at an early stage".

In Pakistan, Dr. A.Q. Khan became a great national hero. He was presented as the person who had saved Pakistan from attack by India by creating Pakistan's own nuclear weapons. In a Washington Post article²⁷ Pervez Hoodbhoy wrote: "Nuclear nationalism was the order of the day as governments vigorously promoted the bomb as the symbol of Pakistan's high scientific achievement and self-respect..." Similar manifestations of nuclear nationalism could also be seen in India after India's 1998 bomb tests.

Early in 2004, it was revealed that Dr. Khan had for years been selling nuclear secrets and equipment to Libya, Iran and North Korea, and that he had contacts with Al-Qaeda. However, observers considered that it was unlikely that Khan would be tried, since a trial might implicate Pakistan's army as well as two of its former prime ministers.

Recent assassination attempts directed at Pakistan's President, Pervez Musharraf, emphasize the precariousness of Pakistan's government. There a danger that it may be overthrown, and that the revolutionists would give Pakistan's nuclear weapons to a subnational organization. This type of danger is a general one associated with nuclear proliferation. As more and more countries obtain nuclear weapons, it becomes increasingly likely that one of them will undergo a revolution, during the course of which nuclear weapons will fall into the hands of criminals or terrorists.

If nuclear reactors become the standard means for electricity generation as the result of

²⁷1 February, 2004

a future energy crisis, the number of nations possessing nuclear weapons might ultimately be as high as 40. If this should happen, then over a long period of time the chance that one or another of these nations would undergo a revolution during which the weapons would fall into the hands of a subnational group would gradually grow into a certainty.

There is also a possibility that poorly-guarded fissionable material could fall into the hands of subnational groups, who would then succeed in constructing their own nuclear weapons. Given a critical mass of highly-enriched uranium, a terrorist group, or an organized criminal (Mafia) group, could easily construct a crude gun-type nuclear explosive device. Pu-239 is more difficult to use since it is highly radioactive, but the physicist Frank Barnaby believes that a subnational group could nevertheless construct a crude nuclear bomb (of the Nagasaki type) from this material.

We must remember the remark of U.N. Secretary General Kofi Annan after the 9/11/2001 attacks on the World Trade Center. He said, "*This time* it was not a nuclear explosion". The meaning of his remark is clear: If the world does not take strong steps to eliminate fissionable materials and nuclear weapons, it will only be a matter of time before they will be used in terrorist attacks on major cities, or by organized criminals for the purpose of extortion. Neither terrorists nor organized criminals can be deterred by the threat of nuclear retaliation, since they have no territory against which such retaliation could be directed. They blend invisibly into the general population. Nor can a "missile defense system" prevent criminals or terrorists from using nuclear weapons, since the weapons can be brought into a port in any one of the hundreds of thousands of containers that enter on ships each year, a number far too large to be checked exhaustively.

Finally we must remember that if the number of nations possessing nuclear weapons becomes very large, there will be a greatly increased chance that these weapons will be used in conflicts between nations, either by accident or through irresponsible political decisions.

On November 3, 2003, Mohamed ElBaradei, Director General of the International Atomic Energy Agency, made a speech to the United Nations in which he called for "limiting the processing of weapons-usable material (separated plutonium and high enriched uranium) in civilian nuclear programs - as well as the production of new material through reprocessing and enrichment - by agreeing to restrict these operations to facilities exclusively under international control." It is almost incredible, considering the dangers of nuclear proliferation and nuclear terrorism, that such restrictions were not imposed long ago.

From the facts that we have been reviewing, we can conclude that if nuclear power generation becomes widespread during a future energy crisis, and if equally widespread proliferation of nuclear weapons is to be avoided, the powers and budget of the IAEA will have to be greatly increased. All enrichment of uranium and Reprocessing fuel rods throughout the world will have to be placed be under direct international control, as has been emphasized by Mohamed ElBaradei. Because this will need to be done with fairness, such regulations will have to hold both in countries that at present have nuclear weapons and in countries that do not. It has been proposed that there should be an international fuel rod bank, to supply new fuel rods and reprocess spent ones. In addition to this excellent proposal, one might also consider a system where all power generation reactors

and all research reactors would be staffed by the IAEA.

Nuclear reactors used for “peaceful” purposes unfortunately also generate fissionable isotopes of not only of plutonium, but also of neptunium and americium. Thus all nuclear reactors must be regarded as ambiguous in function, and all must be put under strict international control. One must ask whether globally widespread use of nuclear energy is worth the danger that it entails.

Let us now examine the question of whether nuclear power generation would appreciably help to prevent global warming. The fraction of nuclear power in the present energy generation spectrum is at present approximately 1/16. Nuclear energy is used primarily for electricity generation. Thus increasing the nuclear fraction would not affect the consumption of fossil fuels used directly in industry, transportation, in commerce, and in the residential sector. Coal is still a very inexpensive fuel, and an increase in nuclear power generation would do little to prevent it from being burned. Thus besides being prohibitively dangerous, and besides being unsustainable in the long run (because of finite stocks of uranium and thorium), the large-scale use of nuclear power cannot be considered to be a solution to the problem of anthropogenic climate change.

Optimists point to the possibility of using fusion of light elements, such as hydrogen, to generate power. However, although this can be done on a very small scale (and at great expense) in laboratory experiments, the practical generation of energy by means of thermonuclear reactions remains a mirage rather than a realistic prospect on which planners can rely. The reason for this is the enormous temperature required to produce thermonuclear reactions. This temperature is comparable to that existing in the interior of the sun, and it is sufficient to melt any ordinary container. Elaborate “magnetic bottles” have been constructed to contain thermonuclear reactions, and these have been used in successful very small scale experiments. However, despite 50 years of heavily-financed research, there has been absolutely no success in producing thermonuclear energy on a large scale, or at anything remotely approaching commercially competitive prices.

Nuclear weapons are criminal! Every war is a crime!

War was always madness, always immoral, always the cause of unspeakable suffering, economic waste and widespread destruction, and always a source of poverty, hate, barbarism and endless cycles of revenge and counter-revenge. It has always been a crime for soldiers to kill people, just as it is a crime for murderers in civil society to kill people. No flag has ever been wide enough to cover up atrocities.

But today, the development of all-destroying modern weapons has put war completely beyond the bounds of sanity and elementary humanity.

Can we not rid ourselves of both nuclear weapons and the institution of war itself? We must act quickly and resolutely before everything that we love in our beautiful world is reduced to radioactive ashes.

3.21 Militarism is the US national religion

Here are some quotations from an article by William Astore entitled *Military Might Is Our National Religion*²⁸. He lists the following facts to support his thesis:

- We believe in wars. We may no longer believe in formal declarations of war (not since December 1941 has Congress made one in our name), but that sure hasn't stopped us from waging them. From Korea to Vietnam, Afghanistan to Iraq, the Cold War to the War on Terror, and so many military interventions in between, including Grenada, Panama, and Somalia, Americans are always fighting somewhere as if we saw great utility in thumbing our noses at the Prince of Peace. (That's Jesus Christ, if I remember my Catholic catechism correctly.)
- We believe in weaponry, the more expensive the better. The underperforming F-35 stealth fighter may cost \$1.45 trillion over its lifetime. An updated nuclear triad (land-based missiles, nuclear submarines, and strategic bombers) may cost that already mentioned \$1.7 trillion. New (and malfunctioning) aircraft carriers cost us more than \$10 billion each. And all such weaponry requests get funded, with few questions asked, despite a history of their redundancy, ridiculously high price, regular cost overruns, and mediocre performance. Meanwhile, Americans squabble bitterly over a few hundred million dollars for the arts and humanities.
- We believe in weapons of mass destruction. We believe in them so strongly that we're jealous of anyone nibbling at our near monopoly. As a result, we work overtime to ensure that "infidels" and atheists (that is, the Iranians and North Koreans, among others) don't get them. In historical terms, no country has devoted more research or money to deadly nuclear, biological, and chemical weaponry than the United States. In that sense, we've truly put our money where our mouths are (and where a devastating future might be).
- We believe with missionary zeal in our military and seek to establish our "faith" everywhere. Hence, our global network of perhaps 800 overseas military bases. We don't hesitate to deploy our elite missionaries, our equivalent to the Jesuits, the Special Operations forces to more than 130 countries annually. Similarly, the foundation for what we like to call foreign assistance is often military training and foreign military sales. Our present supreme leader, Pope Trump I, boasts of military sales across the globe, most notably to the "infidel" Saudis. Even when Congress makes what, until recently, was the rarest of attempts to rein in this deadly trade

²⁸Truthout, August 13, 2019

in arms, Pope Trump vetoes it. His rationale: weapons and profits should rule all.

- We believe in our college of cardinals, otherwise known as America's generals and admirals. We sometimes appoint them (or anoint them?) to the highest positions in the land. While Trump's generals - Michael Flynn, James Mattis, H.R. McMaster, and John Kelly - have fallen from grace at the White House, America's generals and admirals continue to rule globally. They inhabit proconsul-like positions in sweeping geographical commands that (at least theoretically) cover the planet and similarly lead commands aimed at dominating the digital-computer realm and special operations. One of them will head a new force meant to dominate space through time eternal. A "strategic" command (the successor to the Strategic Air Command, or SAC, so memorably satirized in Stanley Kubrick's *Dr. Strangelove*) continues to ensure that, at some future moment, the U.S. will be able to commit mass genocide by quite literally destroying the world with nuclear weapons. Indeed, Pope Trump recently boasted that he could end America's Afghan War in a week, apparently through the mass nuclear genocide of (his figure) 10 million Afghans. Even as he then blandly dismissed the idea of wiping that country "off the face of the earth," he openly reflected the more private megalomania of those military professionals funded by the rest of us to think about "the unthinkable". In sum, everything is - theoretically at least - under the thumbs of our unelected college of cardinals. Their overblown term for it is "full-spectrum dominance," which, in translation, means they grant themselves god-like powers over our lives and that of our planet (though the largely undefeated enemies in their various wars don't seem to have acknowledged this reality).
- We believe that freedom comes through obedience. Those who break ranks from our militarized church and protest, like Chelsea Manning, are treated as heretics and literally tortured.
- We believe military spending brings wealth and jobs galore, even when it measurably doesn't. Military production is both increasingly automated and increasingly outsourced, leading to far fewer good-paying American jobs compared to spending on education, infrastructure repairs of and improvements in roads, bridges, levees, and the like, or just about anything else for that matter.
- We believe, and our most senior leaders profess to believe, that our military represents the very best of us, that we have the "finest" one in human history.



Figure 3.42: The peoples of the world must revolt against the endless wars of their governments. All-destroying modern weapons have made the institution of war prohibitively dangerous.

- We believe in planning for a future marked by endless wars, whether against terrorism or “godless” states like China and Russia, which means our military church must be forever strengthened in the cause of winning ultimate victory.

Suggestions for further reading

1. P.J. Bowler, *Evolution: The History of an Idea*, University of California Press, (1989).
2. D.J. Futuyma, *Evolutionary Biology*, Sinauer Associates, Sunderland Mass., (1986).
3. B. Glass, O. Temkin, and W.L. Strauss, eds., *Forerunners of Darwin: 1745-1859*, Johns Hopkins Press, Baltimore, (1959).
4. R. Milner, *The Encyclopedia of Evolution*, an Owl Book, Henry Holt and Company, New York, (1990).
5. T.A. Appel, *The Cuvier-Geoffroy Debate: French Biology in the Decades before Darwin*, Oxford University Press, (1987).
6. P.J. Bowler, *Fossils and Progress: Paleontology and the Idea of Progressive Evolution in the Nineteenth Century*, Science History Publications, New York, (1976).
7. P. Corsi, *The Age of Lamarck: Evolutionary Theories in France, 1790-1834*, University of California Press, Berkeley, (1988).
8. M. McNeil, *Under the Banner of Science: Erasmus Darwin and his Age*, Manchester University Press, Manchester, (1987).
9. L.G. Wilson, *Sir Charles Lyell's Scientific Journals on the Species Question*, Yale University Press, New Haven, (1970).
10. A.B. Adams, *Eternal Quest: The Story of the Great Naturalists*, G.P. Putnam's Sons, New York, (1969).
11. A.S. Packard, *Lamarck, the Founder of Evolution: His Life and Work*, Longmans, Green, and Co., New York, (1901).
12. C. Darwin, *An historical sketch of the progress of opinion on the Origin of Species, previously to the publication of this work*, Appended to third and later editions of *On the Origin of Species*, (1861).
13. L. Eiseley, *Darwin's Century: Evolution and the Men who Discovered It*, Doubleday, New York, (1958).
14. H.F. Osborne, *From the Greeks to Darwin: The Development of the Evolution Idea Through Twenty-Four Centuries*, Charles Scribner and Sons, New York, (1929).
15. Sir Julian Huxley and H.B.D. Kettlewell, *Charles Darwin and his World*, Thames and Hudson, London (1965).
16. Allan Moorehead, *Darwin and the Beagle*, Penguin Books Ltd. (1971).
17. Francis Darwin (editor), *The Autobiography of Charles Darwin and Selected Letters*, Dover, New York (1958).
18. Charles Darwin, *The Voyage of the Beagle*, J.M. Dent and Sons Ltd., London (1975).
19. Charles Darwin, *The Origin of Species*, Collier MacMillan, London (1974).
20. Charles Darwin, *The Expression of Emotions in Man and Animals*, The University of Chicago Press (1965).
21. Ruth Moore, *Evolution*, Time-Life Books (1962).
22. L. Barber, *The Heyday of Natural History: 1820-1870*, Doubleday and Co., Garden City, New York, (1980).
23. A. Desmond, *Huxley*, Addison Wesley, Reading, Mass., (1994).
24. R. Owen, (P.R. Sloan editor), *The Hunterian Lectures in Comparative Anatomy, May-June, 1837*, University of Chicago Press, (1992).

25. C. Nichols, *Darwinism and the social sciences*, Phil. Soc. Scient. **4**, 255-277 (1974).
26. M. Ruse, *The Darwinian Revolution*, University of Chicago Press, (1979).
27. A. Desmond and J. Moore, *Darwin*, Penguin Books, (1992).
28. R. Dawkins, *The Extended Phenotype*, Oxford University Press, (1982).
29. R. Dawkins, *The Blind Watchmaker*, W.W. Norton, (1987).
30. R. Dawkins, *River out of Eden: A Darwinian View of Life*, Harper Collins, (1995).
31. R. Dawkins, *Climbing Mount Improbable*, W.W. Norton, (1996).
32. S.J. Gould, *Ever Since Darwin*, W.W. Norton, (1977).
33. R.G.B. Reid, *Evolutionary Theory: The Unfinished Synthesis*, Croom Helm, (1985).
34. M. Ho and P.T. Saunders, editors, *Beyond Neo-Darwinism: An Introduction to a New Evolutionary Paradigm*, Academic Press, London, (1984).
35. J. Maynard Smith, *Did Darwin Get it Right? Essays on Games, Sex and Evolution*, Chapman and Hall, (1989).
36. E. Sober, *The Nature of Selection: Evolutionary Theory in Philosophical Focus*, University of Chicago Press, (1984).
37. B.K. Hall, *Evolutionary Developmental Biology*, Chapman and Hall, London, (1992).
38. J. Thompson, *Interaction and Coevolution*, Wiley and Sons, (1982).
39. R.A. Fischer, *The Genetical Theory of Natural Selection*, Clarendon, Oxford, (1930).
40. J.B.S. Haldane, *Population genetics*, New Biology **18**, 34-51, (1955).
41. N. Tinbergen, *The Study of Instinct*, Oxford University Press, (1951).
42. N. Tinbergen, *The Herring Gull's World*, Collins, London, (1953).
43. N. Tinbergen, *Social Behavior in Animals*, Methuen, London, (1953).
44. N. Tinbergen, *Curious Naturalists*, Country Life, London, (1958).
45. N. Tinbergen, *The Animal in its World: Explorations of an Ethologist*, Allan and Unwin, London, (1973).
46. K. Lorenz, *On the evolution of behavior*, Scientific American, December, (1958).
47. K. Lorenz, *Evolution and Modification of Behavior* Harvard University Press, Cambridge, MA, (1961).
48. K. Lorenz, *Studies in Animal and Human Behavior. I and II.*, Harvard University Press, (1970) and (1971).
49. P.H. Klopfer and J.P. Hailman, *An Introduction to Animal Behavior: Ethology's First Century*, Prentice-Hall, New Jersey, (1969).
50. J. Jaynes, *The historical origins of "Ethology" and "Comparative Psychology"*, Anim. Behav. **17**, 601-606 (1969).
51. W.H. Thorpe, *The Origin and Rise of Ethology: The Science of the Natural Behavior of Animals*, Heinemann, London, (1979).
52. R.A. Hinde, *Animal Behavior: A Synthesis of Ethological and Comparative Psychology*, McGraw-Hill, New York, (1970).
53. J.H. Crook, editor, *Social Behavior in Birds and Mammals*, Academic Press, London, (1970).
54. P. Ekman, editor, *Darwin and Facial Expression*, Academic Press, New York, (1973).
55. P. Ekman, W.V. Friesen and P. Ekworth, *Emotions in the Human Face*, Pergamon, New York, (1972).

56. N. Blurton Jones, editor, *Ethological Studies of Child Behavior*, Cambridge University Press, (1975).
57. M. von Cranach, editor, *Methods of Inference from Animals to Human Behavior*, Chicago/Mouton, Haag, (1976); Aldine, Paris, (1976).
58. K. Lorenz, *On Aggression*, Bantem Books, (1977).
59. I. Eibl-Eibesfeldt, *Ethology, The Biology of Behavior*, Holt, Rinehart and Winston, New York, (1975).
60. I. Eibl-Eibesfeldt and F.K. Salter, editors, *Indoctrinability, Ideology, and Warfare: Evolutionary Perspectives*, Berghahn Books, (1998).
61. I. Eibl-Eibesfeldt, *Human Ethology*, Walter De Gruyter Inc., (1989).
62. I. Eibl-Eibesfeldt, *Love and Hate*, Walter De Gruyter Inc., (1996).
63. J. Bowlby, *By ethology out of psychoanalysis: An experiment in interbreeding*, *Animal Behavior*, **28**, 649-656 (1980).
64. B.B. Beck, *Animal Tool Behavior*, Garland STPM Press, New York, (1980).
65. R. Axelrod, *The Evolution of Cooperation*, Basic Books, New York, (1984).
66. J.D. Carthy and F.L. Ebling, *The Natural History of Aggression*, Academic Press, New York, (1964)
67. D.L. Cheney and R.M. Seyfarth, *How Monkeys See the World: Inside the Mind of Another Species*, University of Chicago Press, (1990).
68. F. De Waal, *Chimpanzee Politics*, Cape, London, (1982).
69. M. Edmunds, *Defense in Animals*, Longman, London, (1974).
70. R.D. Estes, *The Behavior Guide to African Mammals*, University of California Press, Los Angeles, (1991).
71. R.F. Ewer, *Ethology of Mammals*, Logos Press, London, (1968).
72. E. Morgan, *The Scars of Evolution*, Oxford University Press, (1990).
73. W.D. Hamilton, *The genetical theory of social behavior. I and II*, *J. Theor. Biol.* **7**, 1-52 (1964).
74. R. Dawkins, *The Selfish Gene*, Oxford University Press, (1989).
75. R.W. Sussman, *The Biological Basis of Human Behavior*, Prentice Hall, Englewood Cliffs, (1997).
76. Irenäus Eibl-Eibesfeldt, *The Biology of Peace and War*, Thames and Hudson, New York (1979).
77. R.A. Hinde, *Biological Bases of Human Social Behavior*, McGraw-Hill, New York (1977).
78. R.A. Hinde, *Towards Understanding Relationships*, Academic Press, London (1979).
79. Albert Szent-Györgyi, *The Crazy Ape*, Philosophical Library, New York (1970).
80. E.O. Wilson, *Sociobiology*, Harvard University Press (1975).
81. C. Zhan-Waxler, *Altruism and Aggression: Biological and Social Origins*, Cambridge University Press (1986).
82. D.R. Griffin, *Animal Mind - Human Mind*, Dahlem Konferenzen 1982, Springer, Berlin, (1982).
83. R. Dart, *The predatory transition from ape to man*, *International Anthropological and Linguistic Review*, **1**, (1953).

84. S. Savage-Rumbaugh, R. Lewin, et al., *Kanzi: The Ape at the Brink of the Human Mind*, John Wiley and Sons, New York, (1996).
85. R. Dunbar, *Grooming, Gossip, and the Evolution of Language*, Harvard University Press, (1998).
86. M.E. Bitterman, *The evolution of intelligence*, Scientific American, January, (1965).
87. R. Fox, *In the beginning: Aspects of hominid behavioral evolution*, Man, **NS 2**, 415-433 (1967).
88. M.S. Gazzaniga, *The split brain in man*, Scientific American, **217**, 24-29 (1967).
89. D. Kimura, *The asymmetry of the human brain*, Scientific American, **228**, 70-78 (1973).
90. R.G. Klein, *Anatomy, behavior, and modern human origins*, Journal of World Prehistory, **9 (2)**, 167-198 (1995).
91. N.G. Jablonski and L.C. Aiello, editors, *The Origin and Diversification of Language*, Wattis Symposium Series in Anthropology. Memoirs of the California Academy of Sciences, No. 24, The California Academy of Sciences, San Francisco, (1998).
92. S. Pinker, *The Language Instinct: How the Mind Creates Language*, Harper-Collins Publishers, New York, (1995).
93. J.H. Barkow, L. Cosmides and J. Tooby, editors, *The Adapted Mind: Evolutionary Psychology and the Generation of Culture*, Oxford University Press, (1995).
94. D.R. Begun, C.V. Ward and M.D. Rose, *Function, Phylogeny and Fossils: Miocene Hominid Evolution and Adaptations*, Plenum Press, New York, (1997).
95. R.W. Byrne and A.W. Whitten, *Machiavellian Intelligence: Social Expertise and the Evolution of Intellect in Monkeys, Apes and Humans*, Cambridge University Press, (1988),
96. V.P. Clark, P.A. Escholz and A.F. Rosa, editors, *Language: Readings in Language and Culture*, St Martin's Press, New York, (1997).
97. T.W. Deacon, *The Symbolic Species: The Co-evolution of Language and the Brain*, W.W. Norton and Company, New York, (1997).
98. C. Gamble, *Timewalkers: The Prehistory of Global Colonization*, Harvard University Press, (1994).
99. K.R. Gibson and T. Ingold, editors, *Tools, Language and Cognition in Human Evolution*, Cambridge University Press, (1993).
100. P. Mellers, *The Emergence of Modern Humans: An Archaeological Perspective*, Edinburgh University Press, (1990).
101. P. Mellers, *The Neanderthal Legacy: An Archaeological Perspective of Western Europe*, Princeton University Press, (1996).
102. S. Mithen, *The Prehistory of the Mind*, Thames and Hudson, London, (1996).
103. D. Haraway, *Signs of dominance: from a physiology to a cybernetics of primate biology*, C.R. Carpenter, 1939-1970, Studies in History of Biology, **6**, 129-219 (1983).
104. D. Johanson and M. Edey, *Lucy: The Beginnings of Humankind*, Simon and Schuster, New York, (1981).
105. B. Kurtén, *Our Earliest Ancestors*, Columbia University Press, New York, (1992).
106. R.E. Leakey and R. Lewin, *Origins Reconsidered*, Doubleday, New York, (1992).

107. P. Lieberman, *The Biology and Evolution of Language*, Harvard University Press, (1984).
108. J.D. Wall and M. Przeworski, *When did the human population size start increasing?*, *Genetics*, **155**, 1865-1874 (2000).
109. L. Aiello and C. Dean, *An Introduction to Human Evolutionary Anatomy*, Academic Press, London, (1990).
110. F. Ikawa-Smith, ed., *Early Paleolithic in South and East Asia*, Mouton, The Hague, (1978).
111. R.R. Baker, *Migration: Paths Through Space and Time*, Hodder and Stoughton, London, (1982).
112. P. Bellwood, *Prehistory of the Indo-Malaysian Archipelago*, Academic Press, Sidney, (1985).
113. P.J. Bowler, *Theories of Human Evolution: A Century of Debate, 1884-1944*, Basil Blackwell, Oxford, (1986).
114. G. Isaac and M. McCown, eds., *Human Origins: Louis Leaky and the East African Evidence*, Benjamin, Menlo Park, (1976).
115. F.J. Brown, R. Leaky, and A. Walker, *Early Homo erectus skeleton from west Lake Turkana, Kenya*, *Nature*, **316**, 788-92, (1985).
116. K.W. Butzer, *Archeology as Human Ecology*, Cambridge University Press, (1982).
117. A.T. Chamberlain and B.A. Wood, *Early hominid phylogeny*, *Journal of Human Evolution*, **16**, 119-33, (1987).
118. P. Mellars and C. Stringer, eds., *The Human Revolution: Behavioural and Biological Perspectives in the Origins of Modern Humans*, Edinburgh University Press, (1989).
119. G.C. Conroy, *Primate Evolution*, W.W. Norton, New York, (1990).
120. R.I.M. Dunbar, *Primate Social Systems*, Croom Helm, London, (1988).
121. B. Fagan, *The Great Journey: The Peopling of Ancient America*, Thames and Hudson, London, (1987).
122. R.A. Foley, ed., *Hominid Evolution and Community Ecology*, Academic Press, New York, (1984).
123. S.R. Binford and L.R. Binford, *Stone tools and human behavior*, *Scientific American*, **220**, 70-84, (1969).
124. G. Klein, *The Human Career, Human Biological and Cultural Origins*, University of Chicago Press, (1989).
125. B.F. Skinner and N. Chomsky, *Verbal behavior*, *Language*, **35** 26-58 (1959).
126. D. Bickerton, *The Roots of Language*, Karoma, Ann Arbor, Mich., (1981).
127. E. Lenneberg in *The Structure of Language: Readings in the Philosophy of Language*, J.A. Fodor and J.A. Katz editors, Prentice-Hall, Englewood Cliffs N.J., (1964).
128. S. Pinker, *Talk of genetics and visa versa*, *Nature*, **413**, 465-466, (2001).
129. S. Pinker, *Words and rules in the human brain*, *Nature*, **387**, 547-548, (1997).
130. M. Ruhelen, *The Origin of Language*, Wiley, New York, (1994).
131. C.B. Stringer and R. McKie, *African Exodus: The Origins of Modern Humanity*, Johnathan Cape, London (1996).

132. R.W. Sussman, *The Biological Basis of Human Behavior*, Prentice Hall, Englewood Cliffs, (1997).
133. D.P. Barash *Sociobiology and Behavior*, Elsevier, New York, (1977).
134. J.D. Carthy and F.J. Eblin, eds., *The Natural History of Aggression*, Academic Press, New York, (1964).
135. N.A. Chagnon and W. Irons, eds., *Evolutionary Biology and Human Social Behavior, an Anthropological Perspective*, Duxbury Press, N. Scituate, MA, (1979).
136. E. Danielson, *Vold, en Ond Arv?*, Gyldendal, Copenhagen, (1929).
137. M.R. Davie, *The Evolution of War*, Yale University Press, New Haven, CT, (1929).
138. T. Dobzhanski, *Mankind Evolving*, Yale University Press, New Haven, CT, (1962).
139. I. Eibl-Eibesfeldt, *Der Vorprogrammiert Mensch*, Molden, Vienna, (1973).
140. I. Eibl-Eibesfeldt, *Ethology, the Biology of Behavior*, Holt, Rinehart and Winston, New York, (1975).
141. I. Eibl-Eibesfeldt, *Liebe und Hass*, Molden, Vienna, (1973).
142. R.L. Holloway, *Primate Aggression: Territoriality and Xenophobia*, Academic Press, New York, (1974).
143. P. Kitcher, *Vaulting Ambition: Sociobiology and the Quest for Human Nature*, MIT Press, Cambridge, MA, (1985).
144. S.L.W. Mellen, *The Evolution of Love*, Freeman, Oxford, (1981).
145. A. Roe and G.G. Simpson, *Behavior and Evolution*, Yale University Press, New Haven, CT, (1958).
146. N.J. Smelser, *The Theory of Collective Behavior*, Free Press, New York, (1963).
147. R. Trivers, *Social Evolution*, Benjamin/Cummings, Menlo Park, CA, (1985).
148. W. Weiser, *Konrad Lorenz und seine Kritiker*, Piper, Munich, (1976).
149. W. Wickler, *Biologie der 10 Gebote*, Piper, Munich, (1971).
150. E.O. Wilson, *Sociobiology*, Harvard University Press (1975).
151. E.O. Wilson, *On Human Nature*, Bantam Books, New York, (1979).
152. C. Zahn-Waxler, *Altruism and Aggression: Biological and Social Origins*, Cambridge University Press, (1986).
153. J. Galtung, *A structural theory of aggression*, Journal of Peace Research, **1**, 95-119, (1964).
154. G.E. Kang, *Exogamy and peace relations of social units: A cross-cultural test*, Ethology, **18**, 85-99, (1979).
155. A. Montagu, *Man and Aggression*, Oxford University Press, New York, (1968).
156. W.A. Nesbitt, *Human Nature and War*, State Education Department of New York, Albany, (1973).
157. W. Suttles, *Subhuman and human fighting*, Anthropologica, **3**, 148-163, (1961).
158. V. Vale and Andrea Juno, editors, *Modern Primitives: An Investigation of Contemporary Adornment and Ritual*, San Francisco Re/Search, (1990).
159. R.A. Hinde, editor, *The Institution of War*, Cambridge University Press, (1991).
160. R.A. Hinde, *Individuals, Relationships and Culture: Links Between Ethology and the Social Sciences*, Cambridge University Press, (1987).
161. R.A. Hinde, *Ethology: Its Nature and Relationship With Other Sciences*

162. R.A. Hinde, *Animal Behaviour: A Synthesis of Ethology and Comparative Psychology*
163. R.A. Hinde, *Non-Verbal Communication*, Cambridge University Press, (1972).
164. R.A. Hinde, *Why Gods Persist: A Scientific Approach to Religion*, Routledge, London, (1999).
165. P.P.G. Bateson and R.A. Hinde, editors, *Growing Points in Ethology: Based on a Conference Sponsored by St. John's College and King's College, Cambridge*, Cambridge University Press, (1976).
166. R.A. Hinde, A.-N. Perret-Clermont and J. Stevenson-Hinde, editors, *Social Relationships and Cognitive Development*, Clarendon, Oxford, (1985).
167. R.A. Hinde and J. Stevenson-Hinde, editors, *Relationships Within Families: Mutual Influences*, Clarendon Press, Oxford, (1988).
168. P. Bateson, editor, *The Development and Integration of Behaviour: Essays in Honour of Robert Hinde*, Cambridge University Press, (1991).
169. C. Darwin, *The Expression of Emotions in Man and Animals*, The University of Chicago Press (1965).
170. P. Kropotkin, *Mutual Aid, A Factor in Evolution*, Walter Heinemann, London, (1902).
171. R.A. Fischer, *The Genetical Theory of Natural Selection*, Clarendon, Oxford, (1930).
172. J.B.S. Haldane, *Population genetics*, *New Biology* **18**, 34-51, (1955).
173. L. Margulis, *Symbiosis as a Source of Evolutionary Innovation: Speciation and Morphogenesis*, The MIT Press, (1991).
174. L. Margulis, *Symbiosis in Cell Evolution: Microbial Communities in the Archean and Proterozoic Eons*, W.H. Freeman, (1992).
175. N. Tinbergen, *The Study of Instinct*, Oxford University Press, (1951).
176. I. Eibl-Eibesfeldt, *The Biology of Peace and War*, Thames and Hudson, New York (1979).
177. E.O. Wilson, *On Human Nature*, Bantam Books, New York, (1979).
178. R.A. Hinde, *Biological Bases of Human Social Behavior*, McGraw-Hill, New York (1977).
179. R.A. Hinde, *Individuals, Relationships and Culture: Links Between Ethology and the Social Sciences*, Cambridge University Press, (1987).
180. W.M. Senner, editor, *The Origins of Writing*, University of Nebraska Press, Lincoln and London, (1989).
181. A. Robock, L. Oman, G. L. Stenchikov, O. B. Toon, C. Bardeen, and R. Turco, *Climatic consequences of regional nuclear conflicts*, *Atmospheric Chemistry and Physics*, Vol. 7, p. 2003-2012, (2007).
182. M. Mills, O. Toon, R. Turco, D. Kinnison, R. Garcia, *Massive global ozone loss predicted following regional nuclear conflict*, *Proceedings of the National Academy of Sciences (USA)*, vol. 105(14), pp. 5307-12, Apr 8, (2008).
183. O. Toon, A. Robock, and R. Turco, *The Environmental Consequences of Nuclear War*, *Physics Today*, vol. 61, No. 12, p. 37-42, (2008).

184. R. Turco, O. Toon, T. Ackermann, J. Pollack, and C. Sagan, *Nuclear Winter: Global consequences of multiple nuclear explosions*, Science, Vol. 222, No. 4630, pp. 1283-1292, December (1983).
185. A. Robock, L. Oman, G. Stenchikov, *Nuclear winter revisited with a modern climate model and current nuclear arsenals: Still catastrophic consequences*, Journal of Geophysical Research - Atmospheres, Vol. 112, No. D13, p. 4 of 14, (2007).
186. I. Helfand, *An Assessment of the Extent of Projected Global Famine Resulting From Limited, Regional Nuclear War*, International Physicians for the Prevention of Nuclear War, Physicians for Social Responsibility, Leeds, MA, (2007).
187. George P. Schultz, William J. Perry, Henry A. Kissinger and Sam Nunn, *A World Free of Nuclear Weapons*, The Wall Street Journal, January 4, 2007, page A15 and January 15, (2008), page A15.
188. Mikhail Gorbachev, *The Nuclear Threat*, The Wall Street Journal, January 30, (2007), page A15.
189. Massimo D'Alema, Gianfranco Fini, Giorgio La Malfa, Arturo Parisi and Francesco Calogero, *For a World Free of Nuclear Weapons*, Corriere Della Sera, July 24, (2008).
190. Hoover Institution, *Reykjavik Revisited; Steps Towards a World Free of Nuclear Weapons*, October, (2007).
191. Douglas Hurd, Malcolm Rifkind, David Owen and George Robertson, *Start Worrying and Learn to Ditch the Bomb*, The Times, June 30, (2008).
192. Des Brown, Secretary of State for Defense, UK, *Laying the Foundations for Multilateral Disarmament*, Geneva Conference on Disarmament, February 5, (2008).
193. Government of Norway, International Conference on *Achieving the Vision of a World Free of Nuclear Weapons*, Oslo, Norway, February 26-27, (2008).
194. Jonas Gahr Støre, Foreign Minister, Norway, *Statement at the Conference on Disarmament*, Geneva, March 4, (2008).
195. Anne-Grete Strøm-Erichsen, Defense Minister, Norway, *Emerging Opportunities for Nuclear Disarmament*, Pugwash Conference, Canada, July 11, (2008).
196. Kevin Rudd, Prime Minister, Australia, *International Commission on Nuclear Non-Proliferation and Disarmament*, Media Release, July 9, (2008).
197. Helmut Schmidt, Richard von Weizsäcker, Egon Bahr and Hans-Dietrich Genscher, *Towards a Nuclear-Free World: a German View*, International Herald Tribune, January 9, (2009).
198. Hans M. Kristensen and Elliot Negin, *Support Growing for Removal of U.S. Nuclear Weapons from Europe*, Common Dreams Newscenter, first posted May 6, (2005).
199. David Krieger, *President-elect Obama and a World Free of Nuclear Weapons*, Nuclear Age Peace Foundation Website, (2008).
200. J.L. Henderson, *Hiroshima*, Longmans (1974).
201. A. Osada, *Children of the A-Bomb, The Testament of Boys and Girls of Hiroshima*, Putnam, New York (1963).
202. M. Hachiya, M.D., *Hiroshima Diary*, The University of North Carolina Press, Chapel Hill, N.C. (1955).
203. M. Yass, *Hiroshima*, G.P. Putnam's Sons, New York (1972).

204. R. Jungk, *Children of the Ashes*, Harcourt, Brace and World (1961).
205. B. Hirschfield, *A Cloud Over Hiroshima*, Baily Brothers and Swinfin Ltd. (1974).
206. J. Hersey, *Hiroshima*, Penguin Books Ltd. (1975).
207. R. Rhodes, *Dark Sun: The Making of the Hydrogen Bomb*, Simon and Schuster, New York, (1995)
208. R. Rhodes, *The Making of the Atomic Bomb*, Simon and Schuster, New York, (1988).
209. D.V. Babst et al., *Accidental Nuclear War: The Growing Peril*, Peace Research Institute, Dundas, Ontario, (1984).
210. S. Britten, *The Invisible Event: An Assessment of the Risk of Accidental or Unauthorized Detonation of Nuclear Weapons and of War by Miscalculation*, Menard Press, London, (1983).
211. M. Dando and P. Rogers, *The Death of Deterrence*, CND Publications, London, (1984).
212. N.F. Dixon, *On the Psychology of Military Incompetence*, Futura, London, (1976).
213. D. Frei and C. Catrina, *Risks of Unintentional Nuclear War*, United Nations, Geneva, (1982).
214. H. L'Etang, *Fit to Lead?*, Heinemann Medical, London, (1980).
215. SPANW, *Nuclear War by Mistake - Inevitable or Preventable?*, Swedish Physicians Against Nuclear War, Lulea, (1985).
216. J. Goldblat, *Nuclear Non-proliferation: The Why and the Wherefore*, (SIPRI Publications), Taylor and Francis, (1985).
217. J. Schear, ed., *Nuclear Weapons Proliferation and Nuclear Risk*, Gower, London, (1984).
218. D.P. Barash and J.E. Lipton, *Stop Nuclear War! A Handbook*, Grove Press, New York, (1982).
219. C.F. Barnaby and G.P. Thomas, eds., *The Nuclear Arms Race: Control or Catastrophe*, Francis Pinter, London, (1982).
220. L.R. Beres, *Apocalypse: Nuclear Catastrophe in World Politics*, Chicago University press, Chicago, IL, (1980).
221. F. Blackaby et al., eds., *No-first-use*, Taylor and Francis, London, (1984).
222. NS, ed., *New Statesman Papers on Destruction and Disarmament* (NS Report No. 3), New Statesman, London, (1981).
223. H. Caldicot, *Missile Envy: The Arms Race and Nuclear War*, William Morrow, New York, (1984).
224. R. Ehrlich, *Waging the Peace: The Technology and Politics of Nuclear Weapons*, State University of New York Press, Albany, NY, (1985).
225. W. Epstein, *The Prevention of Nuclear War: A United Nations Perspective*, Gunn and Hain, Cambridge, MA, (1984).
226. W. Epstein and T. Toyoda, eds., *A New Design for Nuclear Disarmament*, Spokesman, Nottingham, (1975).
227. G.F. Kennan, *The Nuclear Delusion*, Pantheon, New York, (1983).
228. R.J. Lifton and R. Falk, *Indefensible Weapons: The Political and Psychological Case Against Nuclearism*, Basic Books, New York, (1982).

229. J.R. Macy, *Despair and Personal Power in the Nuclear Age*, New Society Publishers, Philadelphia, PA, (1983).
230. A.S. Miller et al., eds., *Nuclear Weapons and Law*, Greenwood Press, Westport, CT, (1984).
231. MIT Coalition on Disarmament, eds., *The Nuclear Almanac: Confronting the Atom in War and Peace*, Addison-Wesley, Reading, MA, (1984).
232. UN, *Nuclear Weapons: Report of the Secretary-General of the United Nations*, United Nations, New York, (1980).
233. IC, *Proceedings of the Conference on Understanding Nuclear War*, Imperial College, London, (1980).
234. B. Russell, *Common Sense and Nuclear Warfare*, Allen and Unwin, London, (1959).
235. F. Barnaby, *The Nuclear Age*, Almqvist and Wiksell, Stockholm, (1974).
236. D. Albright, F. Berkhout and W. Walker, *Plutonium and Highly Enriched Uranium 1996: World Inventories, Capabilities and Policies*, Oxford University Press, Oxford, (1997).
237. G.T. Allison et al., *Avoiding Nuclear Anarchy: Containing the Threat of Loose Russian Nuclear Weapons and Fissile Material*, MIT Press, Cambridge MA, (1996).
238. B. Bailin, *The Making of the Indian Atomic Bomb: Science, Secrecy, and the Post-colonial State*, Zed Books, London, (1998).
239. P. Bidawi and A. Vanaik, *South Asia on a Short Fuse: Nuclear Politics and the Future of Global Disarmament*, Oxford University Press, Oxford, (2001).
240. F.A. Boyle, *The Criminality of Nuclear Deterrence: Could the U.S. War on Terrorism Go Nuclear?*, Clarity Press, Atlanta GA, (2002).
241. G. Burns, *The Atomic Papers: A Citizen's Guide to Selected Books and Articles on the Bomb, the Arms Race, Nuclear Power, the Peace Movement, and Related Issues*, Scarecrow Press, Metuchen NJ, (1984).
242. L. Butler, *A Voice of Reason*, The Bulletin of Atomic Scientists, **54**, 58-61, (1998).
243. R. Butler, *Fatal Choice: Nuclear Weapons and the Illusion of Missile Defense*, Westview Press, Boulder CO, (2001).
244. R.P. Carlisle (Ed.), *Encyclopedia of the Atomic Age*, Facts on File, New York, (2001).
245. G.A. Cheney, *Nuclear Proliferation: The Problems and Possibilities*, Franklin Watts, New York, (1999).
246. A. Cohen, *Israel and the Bomb*, Columbia University Press, New York, (1998).
247. S.J. Diehl and J.C. Moltz, *Nuclear Weapons and Nonproliferation: A Reference Handbook*, ABC-Clio Information Services, Santa Barbara CA, (2002).
248. H.A. Feiveson (Ed.), *The Nuclear Turning Point: A Blueprint for Deep Cuts and De-Alerting of Nuclear Weapons*, Brookings Institution Press, Washington D.C., (1999).
249. R. Hilsman, *From Nuclear Military Strategy to a World Without War: A History and a Proposal*, Praeger Publishers, Westport, (1999).
250. International Physicians for the Prevention of Nuclear War and The Institute for Energy and Environmental Research *Plutonium: Deadly Gold of the Nuclear Age*, International Physicians Press, Cambridge MA, (1992).

251. R.W. Jones and M.G. McDonough, *Tracking Nuclear Proliferation: A Guide in Maps and Charts, 1998*, The Carnegie Endowment for International Peace, Washington D.C., (1998).
252. R.J. Lifton and R. Falk, *Indefensible Weapons: The Political and Psychological Case Against Nuclearism*, Basic Books, New York, (1982).
253. R.E. Powaski, *March to Armageddon: The United States and the Nuclear Arms Race, 1939 to the Present*, Oxford University Press, (1987).
254. J. Rotblat, J. Steinberger and B. Udgaonkar (Eds.), *A Nuclear-Weapon-Free World: Desirable? Feasible?*, Westview Press, (1993).
255. The United Methodist Council of Bishops, *In Defense of Creation: The Nuclear Crisis and a Just Peace*, Graded Press, Nashville, (1986).
256. U.S. Congress Office of Technology Assessment (Ed.), *Dismantling the Bomb and Managing the Nuclear Materials*, U.S. Government Printing Office, Washington D.C., (1993).
257. S.R. Weart, *Nuclear Fear: A History of Images*, Harvard University Press, (1988).
258. P. Boyer, *By the Bomb's Early Light: American Thought and Culture at the Dawn of the Atomic Age*, University of North Carolina Press, (1985).
259. C. Perrow, *Normal Accidents: Living With High-Risk Technologies*, Basic Books, (1984).
260. P. Rogers, *The Risk of Nuclear Terrorism in Britain*, Oxford Research Group, Oxford, (2006).
261. MIT, *The Future of Nuclear Power: An Interdisciplinary MIT Study*, <http://web.mit.edu/nuclearpower> (2003).
262. Z. Mian and A. Glaser, *Life in a Nuclear Powered Crowd*, INES Newsletter No. 52, 9-13, April, (2006).
263. K. Bergeron, *Nuclear Weapons: The Death of No Dual-use*, Bulletin of the Atomic Scientists, 15-17, January, (2004).
264. E. Chivian, and others (eds.), *Last Aid: The Medical Dimensions of Nuclear War*, W.H. Freeman, San Francisco, (1982).
265. Medical Association's Board of Science and Education, *The Medical Effects of Nuclear War*, Wiley, (1983).
266. Kevin Rudd, Prime Minister, Australia, "International Commission on Nuclear Non-Proliferation and Disarmament", Media Release, July 9, 2008.
267. Global Zero, www.globalzero.org/paris-conference
268. Helmut Schmidt, Richard von Weizäcker, Egon Bahr and Hans-Dietrich Genscher, "Towards a Nuclear-Free World: a German View", International Herald Tribune, January 9, 2009.
269. Hans M. Kristensen and Elliot Negin, "Support Growing for Removal of U.S. Nuclear Weapons from Europe", Common Dreams Newscenter, first posted May 6, 2005.
270. David Krieger, "President-elect Obama and a World Free of Nuclear Weapons", Nuclear Age Peace Foundation Website, 2008.
271. J.L. Henderson, *Hiroshima*, Longmans (1974).

272. A. Osada, *Children of the A-Bomb, The Testament of Boys and Girls of Hiroshima*, Putnam, New York (1963).
273. M. Hachiya, M.D., *Hiroshima Diary*, The University of North Carolina Press, Chapel Hill, N.C. (1955).
274. M. Yass, *Hiroshima*, G.P. Putnam's Sons, New York (1972).
275. R. Jungk, *Children of the Ashes*, Harcourt, Brace and World (1961).
276. B. Hirschfield, *A Cloud Over Hiroshima*, Baily Brothers and Swinfin Ltd. (1974).
277. J. Hersey, *Hiroshima*, Penguin Books Ltd. (1975).
278. R. Rhodes, *Dark Sun: The Making of the Hydrogen Bomb*, Simon and Schuster, New York, (1995)
279. R. Rhodes, *The Making of the Atomic Bomb*, Simon and Schuster, New York, (1988).
280. D.V. Babst et al., *Accidental Nuclear War: The Growing Peril*, Peace Research Institute, Dundas, Ontario, (1984).
281. S. Britten, *The Invisible Event: An Assessment of the Risk of Accidental or Unauthorized Detonation of Nuclear Weapons and of War by Miscalculation*, Menard Press, London, (1983).
282. M. Dando and P. Rogers, *The Death of Deterrence*, CND Publications, London, (1984).
283. N.F. Dixon, *On the Psychology of Military Incompetence*, Futura, London, (1976).
284. D. Frei and C. Catrina, *Risks of Unintentional Nuclear War*, United Nations, Geneva, (1982).
285. H. L'Etang, *Fit to Lead?*, Heinemann Medical, London, (1980).
286. SPANW, *Nuclear War by Mistake - Inevitable or Preventable?*, Swedish Physicians Against Nuclear War, Lulea, (1985).
287. J. Goldblat, *Nuclear Non-proliferation: The Why and the Wherefore*, (SIPRI Publications), Taylor and Francis, (1985).
288. IAEA, *International Safeguards and the Non-proliferation of Nuclear Weapons*, International Atomic Energy Agency, Vienna, (1985).
289. J. Schear, ed., *Nuclear Weapons Proliferation and Nuclear Risk*, Gower, London, (1984).
290. D.P. Barash and J.E. Lipton, *Stop Nuclear War! A Handbook*, Grove Press, New York, (1982).
291. C.F. Barnaby and G.P. Thomas, eds., *The Nuclear Arms Race: Control or Catastrophe*, Francis Pinter, London, (1982).
292. L.R. Beres, *Apocalypse: Nuclear Catastrophe in World Politics*, Chicago University press, Chicago, IL, (1980).
293. F. Blackaby et al., eds., *No-first-use*, Taylor and Francis, London, (1984).
294. NS, ed., *New Statesman Papers on Destruction and Disarmament* (NS Report No. 3), New Statesman, London, (1981).
295. H. Caldicot, *Missile Envy: The Arms Race and Nuclear War*, William Morrow, New York, (1984).
296. R. Ehrlich, *Waging the Peace: The Technology and Politics of Nuclear Weapons*, State University of New York Press, Albany, NY, (1985).

297. W. Epstein, *The Prevention of Nuclear War: A United Nations Perspective*, Gunn and Hain, Cambridge, MA, (1984).
298. W. Epstein and T. Toyoda, eds., *A New Design for Nuclear Disarmament*, Spokesman, Nottingham, (1975).
299. G.F. Kennan, *The Nuclear Delusion*, Pantheon, New York, (1983).
300. R.J. Lifton and R. Falk, *Indefensible Weapons: The Political and Psychological Case Against Nuclearism*, Basic Books, New York, (1982).
301. J.R. Macy, *Despair and Personal Power in the Nuclear Age*, New Society Publishers, Philadelphia, PA, (1983).
302. A.S. Miller et al., eds., *Nuclear Weapons and Law*, Greenwood Press, Westport, CT, (1984).
303. MIT Coalition on Disarmament, eds., *The Nuclear Almanac: Confronting the Atom in War and Peace*, Addison-Wesley, Reading, MA, (1984).
304. UN, *Nuclear Weapons: Report of the Secretary-General of the United Nations*, United Nations, New York, (1980).
305. IC, *Proceedings of the Conference on Understanding Nuclear War*, Imperial College, London, (1980).
306. B. Russell, *Common Sense and Nuclear Warfare*, Allen and Unwin, London, (1959).
307. F. Barnaby, *The Nuclear Age*, Almqvist and Wiksell, Stockholm, (1974).
308. D. Albright, F. Berkhout and W. Walker, *Plutonium and Highly Enriched Uranium 1996: World Inventories, Capabilities and Policies*, Oxford University Press, Oxford, (1997).
309. G.T. Allison et al., *Avoiding Nuclear Anarchy: Containing the Threat of Loose Russian Nuclear Weapons and Fissile Material*, MIT Press, Cambridge MA, (1996).
310. B. Bailin, *The Making of the Indian Atomic Bomb: Science, Secrecy, and the Post-colonial State*, Zed Books, London, (1998).
311. G.K. Bertsch and S.R. Grillot, (Eds.), *Arms on the Market: Reducing the Risks of Proliferation in the Former Soviet Union*, Routledge, New York, (1998).
312. P. Bidawi and A. Vanaik, *South Asia on a Short Fuse: Nuclear Politics and the Future of Global Disarmament*, Oxford University Press, Oxford, (2001).
313. F.A. Boyle, *The Criminality of Nuclear Deterrence: Could the U.S. War on Terrorism Go Nuclear?*, Clarity Press, Atlanta GA, (2002).
314. G. Burns, *The Atomic Papers: A Citizen's Guide to Selected Books and Articles on the Bomb, the Arms Race, Nuclear Power, the Peace Movement, and Related Issues*, Scarecrow Press, Metuchen NJ, (1984).
315. L. Butler, *A Voice of Reason*, The Bulletin of Atomic Scientists, **54**, 58-61, (1998).
316. R. Butler, *Fatal Choice: Nuclear Weapons and the Illusion of Missile Defense*, Westview Press, Boulder CO, (2001).
317. R.P. Carlisle (Ed.), *Encyclopedia of the Atomic Age*, Facts on File, New York, (2001).
318. G.A. Cheney, *Nuclear Proliferation: The Problems and Possibilities*, Franklin Watts, New York, (1999).
319. A. Cohen, *Israel and the Bomb*, Columbia University Press, New York, (1998).

320. S.J. Diehl and J.C. Moltz, *Nuclear Weapons and Nonproliferation: A Reference Handbook*, ABC-Clio Information Services, Santa Barbara CA, (2002).
321. H.A. Feiveson (Ed.), *The Nuclear Turning Point: A Blueprint for Deep Cuts and De-alerting of Nuclear Weapons*, Brookings Institution Press, Washington D.C., (1999).
322. R. Hilsman, *From Nuclear Military Strategy to a World Without War: A History and a Proposal*, Praeger Publishers, Westport, (1999).
323. International Physicians for the Prevention of Nuclear War and The Institute for Energy and Environmental Research *Plutonium: Deadly Gold of the Nuclear Age*, International Physicians Press, Cambridge MA, (1992).
324. R.W. Jones and M.G. McDonough, *Tracking Nuclear Proliferation: A Guide in Maps and Charts, 1998*, The Carnegie Endowment for International Peace, Washington D.C., (1998).
325. R.J. Lifton and R. Falk, *Indefensible Weapons: The Political and Psychological Case Against Nuclearism*, Basic Books, New York, (1982).
326. J. Rotblat, J. Steinberger and B. Udgaonkar (Eds.), *A Nuclear-Weapon-Free World: Desirable? Feasible?*, Westview Press, (1993).
327. The United Methodist Council of Bishops, *In Defense of Creation: The Nuclear Crisis and a Just Peace*, Graded Press, Nashville, (1986).
328. U.S. Congress Office of Technology Assessment (Ed.), *Dismantling the Bomb and Managing the Nuclear Materials*, U.S. Government Printing Office, Washington D.C., (1993).
329. S.R. Weart, *Nuclear Fear: A History of Images*, Harvard University Press, (1988).
330. P. Boyer, *By the Bomb's Early Light: American Thought and Culture at the Dawn of the Atomic Age*, University of North Carolina Press, (1985).
331. A. Makhijani and S. Saleska, *The Nuclear Power Deception: Nuclear Mythology From Electricity 'Too Cheap to Meter' to 'Inherently Safe' Reactors*, Apex Press, (1999).
332. C. Perrow, *Normal Accidents: Living With High-Risk Technologies*, Basic Books, (1984).
333. P. Rogers, *The Risk of Nuclear Terrorism in Britain*, Oxford Research Group, Oxford, (2006).
334. MIT, *The Future of Nuclear Power: An Interdisciplinary MIT Study*, <http://web.mit.edu/nuclearpow> (2003).
335. Z. Mian and A. Glaser, *Life in a Nuclear Powered Crowd*, INES Newsletter No. 52, 9-13, April, (2006).
336. E. Chivian, and others (eds.), *Last Aid: The Medical Dimensions of Nuclear War*, W.H. Freeman, San Fransisco, (1982).
337. P.B. Smith, J.D. Schilling and A.P. Haines, *Introduction and Summary*, in *Draft Report of the Pugwash Study Group: The World at the Crossroads*, Berlin, (1992).
338. World Resources Institute, *World Resources*, Oxford University Press, New York, (published annually).
339. J.R. Craig, D.J. Vaughan and B.J. Skinner, *Resources of the Earth: Origin, Use and Environmental Impact, Third Edition*, Prentice Hall, (2001).

340. W. Youngquist, *Geodesinies: The Inevitable Control of Earth Resources Over Nations and Individuals*, National Book Company, Portland Oregon, (1997).
341. M. Tanzer, *The Race for Resources. Continuing Struggles Over Minerals and Fuels*, Monthly Review Press, New York, (1980).
342. C.B. Reed, *Fuels, Minerals and Human Survival*, Ann Arbor Science Publishers Inc., Ann Arbor Michigan, (1975).
343. A.A. Bartlett, *Forgotten Fundamentals of the Energy Crisis*, American Journal of Physics, **46**, 876-888, (1978).
344. N. Gall, *We are Living Off Our Capital*, Forbes, September, (1986).

Chapter 4

THE DANGER OF WIDESPREAD FAMINE

4.1 Several billion people might suffer

There is a danger that population growth, climate change and the end of the fossil fuel era could combine to produce an extremely large-scale global famine by the middle of the present century. Such a famine might involve several billion people, rather than millions.

4.2 Child mortality rates

Here are some quotations from an article entitled *Child mortality rates drop but 15,000 children under 5 still die each day*, published in *Agriculture at a Crossroads* on September 18, 2018:¹

Although the global number of child deaths remains high, the world has made tremendous progress in reducing child mortality over the past few decades. The total number of under-five deaths dropped to 5.3 million in 2018, down from 12.5 million in 1990. This is the main message of a report published today by UN organizations led by UNICEF and the World Health Organization (WHO). According to the “Levels and trends in child mortality: Report 2019”, more women and their children are surviving today than ever before. Since 2000, child deaths have reduced by nearly half and maternal deaths by over one-third, mostly due to improved access to affordable, quality health services. However, in 2018 alone, 15,000 children died per day before reaching their fifth birthday. “It is especially unacceptable that these children and young adolescents died largely of preventable or treatable causes like infectious diseases and injuries when we have the means to prevent these deaths,” the authors write

¹<https://www.globalagriculture.org/whats-new/news/en/33802.html>

in the introduction to the report. The global under-five mortality rate fell to 39 deaths per 1,000 live births in 2018, down from 76 in 2000 - a 49% decline.

“Despite advances in fighting childhood illnesses, infectious diseases remain a leading cause of death for children under the age of 5, particularly in sub-Saharan Africa and Southern Asia,” says the report. Pneumonia remains the leading cause of death globally among children under the age of 5, accounting for 15% of deaths. Diarrhoea (8%) and malaria (5%), together with pneumonia, accounted for almost a third of global under-five deaths in 2018. “Malnourished children, particularly those with severe acute malnutrition, have a higher risk of death from these common childhood illnesses. Nutrition-related factors contribute to about 45 per cent of deaths in children under 5 years of age,” warns the report. The estimates also show vast inequalities worldwide, with women and children in sub-Saharan Africa facing a higher risk of death than in all other regions. Level of maternal deaths are nearly 50 times higher for women in sub-Saharan Africa compared to high-income countries. In 2018, 1 in 13 children in sub-Saharan Africa died before their fifth birthday - this is 15 times higher than the risk a child faces in Europe, where just 1 in 196 children aged less than 5 die.

4.3 The threat of large-scale famine

As glaciers melt in the Himalayas, depriving India and China of summer water supplies; as sea levels rise, drowning the fertile rice fields of Viet Nam and Bangladesh; as drought threatens the productivity of grain-producing regions of North America; and as the end of the fossil fuel era impacts modern high-yield agriculture, there is a threat of wide-spread famine. There is a danger that the 1.5 billion people who are undernourished today will not survive an even more food-scarce future.

People threatened with famine will become refugees, desperately seeking entry into countries where food shortages are less acute. Wars, such as those currently waged in the Middle East, will add to the problem.

What can we do to avoid this crisis, or at least to reduce its severity? We must urgently address the problem of climate change; and we must shift money from military expenditure to the support of birth control programs and agricultural research. We must also replace the institution of war by a system of effective global governance and enforceable international laws.

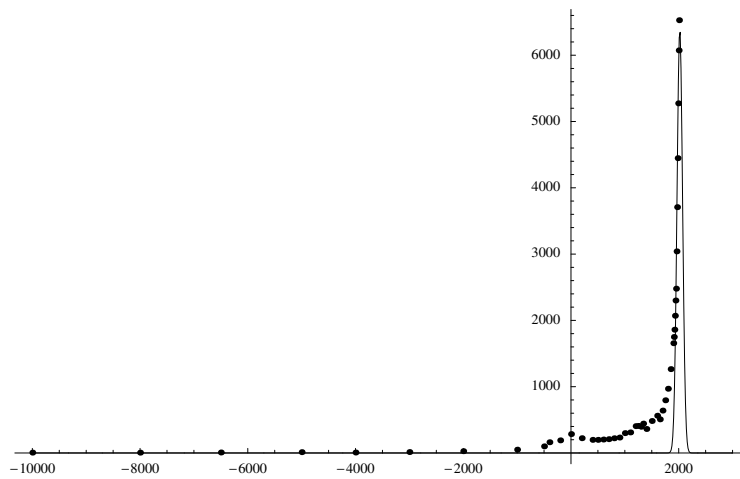

Figure 4.1: Population growth and fossil fuel use, seen on a time-scale of several thousand years. The dots are population estimates in millions from the US Census Bureau. Fossil fuel use appears as a spike-like curve, rising from almost nothing to a high value, and then falling again to almost nothing in the space of a few centuries. When the two curves are plotted together, the explosive rise of global population is seen to be simultaneous with, and perhaps partially driven by, the rise of fossil fuel use. This raises the question of whether the world's population is headed for a crash when the fossil fuel era has ended. (Author's own graph)

4.4 Optimum population in the distant future

What is the optimum population of the world? It is certainly not the maximum number that can be squeezed onto the globe by eradicating every species of plant and animal that cannot be eaten. The optimum global population is one that can be supported in comfort, equality and dignity - and with respect for the environment.

In 1848 (when there were just over one billion people in the world), John Stuart Mill described the optimal global population in the following words:

“The density of population necessary to enable mankind to obtain, in the greatest degree, all the advantages of cooperation and social intercourse, has, in the most populous countries, been attained. A population may be too crowded, although all be amply supplied with food and raiment.”

“... Nor is there much satisfaction in contemplating the world with nothing left to the spontaneous activity of nature; with every rood of land brought into cultivation, which is capable of growing food for human beings; every flowery waste or natural pasture plowed up, all quadrupeds or birds which are not domesticated for man’s use exterminated as his rivals for food, every hedgerow or superfluous tree rooted out, and scarcely a place left where a wild shrub or flower could grow without being eradicated as a weed in the name of improved agriculture. If the earth must lose that great portion of its pleasantness which it owes to things that the unlimited increase of wealth and population would extirpate from it, for the mere purpose of enabling it to support a larger, but not better or happier population, I sincerely hope, for the sake of posterity, that they will be content to be stationary, long before necessity compels them to it.”²

Has the number of humans in the world already exceeded the earth’s sustainable limits? Will the global population of humans crash catastrophically after having exceeded the carrying capacity of the environment? There is certainly a danger that this will happen - a danger that the 21st century will bring very large scale famines to vulnerable parts of the world, because modern energy-intensive agriculture will be dealt a severe blow by prohibitively high petroleum prices, and because climate change will reduce the world’s agricultural output. When the major glaciers in the Himalayas have melted, they will no longer be able to give India and China summer water supplies; rising oceans will drown much agricultural land; and aridity will reduce the output of many regions that now produce much of the world’s grain. Falling water tables in overdrawn aquifers, and loss of topsoil will add to the problem. We should be aware of the threat of a serious global food crisis in the 21st century if we are to have a chance of avoiding it.

The term *ecological footprint* was introduced by William Rees and Mathis Wackernagel in the early 1990’s to compare demands on the environment with the earth’s capacity to regenerate. In 2005, humanity used environmental resources at such a rate that it would take 1.3 earths to renew them. In other words, we have already exceeded the earth’s carrying capacity. Since eliminating the poverty that characterizes much of the world

²John Stuart Mill, *Principles of Political Economy, With Some of Their Applications to Social Philosophy*, (1848).

today will require more resources per capita, rather than less. it seems likely that in the era beyond fossil fuels, the optimum global population will be considerably less than the present population of the world.

4.5 Population growth and the Green Revolution

Limitations on cropland

In 1944 the Norwegian-American plant geneticist Norman Borlaug was sent to Mexico by the Rockefeller Foundation to try to produce new wheat varieties that might increase Mexico's agricultural output. Borlaug's dedicated work on this project was spectacularly successful. He remained with the project for 16 years, and his group made 6,000 individual crossings of wheat varieties to produce high-yield disease-resistant strains.

In 1963, Borlaug visited India, bringing with him 100 kg. of seeds from each of his most promising wheat strains. After testing these strains in Asia, he imported 450 tons of the Lerma Rojo and Sonora 64 varieties - 250 tons for Pakistan and 200 for India. By 1968, the success of these varieties was so great that school buildings had to be commandeered to store the output. Borlaug's work began to be called a "Green Revolution". In India, the research on high-yield crops was continued and expanded by Prof. M.S. Swaminathan and his coworkers. The work of Green Revolution scientists, such Norman Borlaug and M.S. Swaminathan, has been credited with saving the lives of as many as a billion people.

Despite these successes, Borlaug believes that the problem of population growth is still a serious one. "Africa and the former Soviet republics", Borlaug states, "and the Cerrado³, are the last frontiers. After they are in use, the world will have no additional sizable blocks of arable land left to put into production, unless you are willing to level whole forests, which you should not do. So, future food-production increases will have to come from higher yields. And though I have no doubt that yields will keep going up, whether they can go up enough to feed the population monster is another matter. Unless progress with agricultural yields remains very strong, the next century will experience human misery that, on a sheer numerical scale, will exceed the worst of everything that has come before."

With regard to the prospect of increasing the area of cropland, a report by the United Nations Food and Agricultural Organization (*Provisional Indicative World Plan for Agricultural Development*, FAO, Rome, 1970) states that "In Southern Asia,... in some countries of Eastern Asia, in the Near East and North Africa... there is almost no scope for expanding agricultural area... In the drier regions, it will even be necessary to return to permanent pasture the land that is marginal and submarginal for cultivation. In most of Latin America and Africa south of the Sahara, there are still considerable possibilities for expanding cultivated areas; but the costs of development are high, and it will often be more economical to intensify the utilization of areas already settled." Thus there is a possibility of increasing the area of cropland in Africa south of the Sahara and in Latin America, but

³ The Cerrado is a large savanna region of Brazil.



Figure 4.2: **Professor M.S. Swaminathan, father of the Green Revolution in India.** (Open and Shut7)



Figure 4.3: **Norman Borlaug and agronomist George Harrer in 1943.** (Human Wrongs Watch)

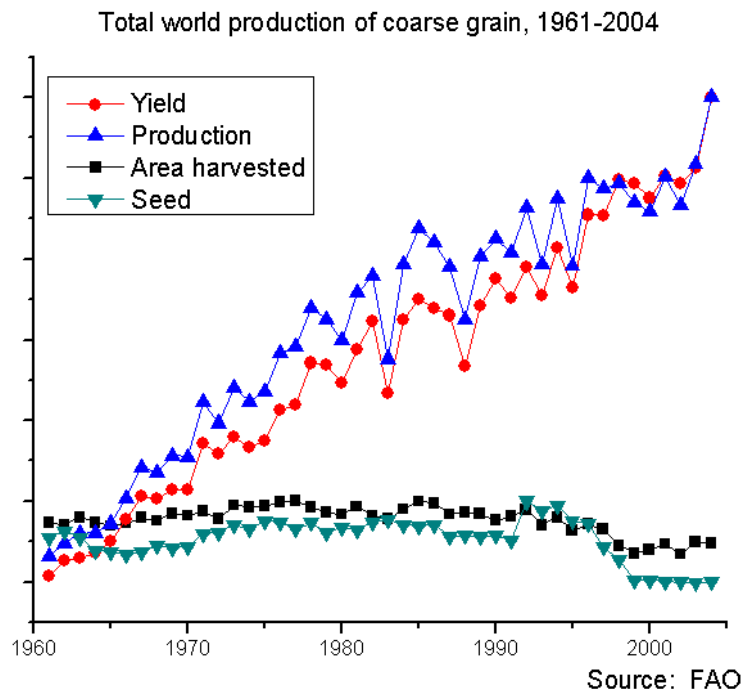

Figure 4.4: This graph shows the total world production of coarse grain between 1960 and 2004. Because of high-yield varieties, the yield of grain increased greatly. Notice, however, that the land under cultivation remained almost constant. High-yield agriculture depends on large inputs of fossil fuel energy and irrigation, and may be difficult to maintain in the future. (FAO)

only at the cost of heavy investment and at the additional cost of destruction of tropical rain forests.

Rather than an increase in the global area of cropland, we may encounter a future loss of cropland through soil erosion, salination, desertification, loss of topsoil, depletion of minerals in topsoil, urbanization and failure of water supplies. In China and in the southwestern part of the United States, water tables are falling at an alarming rate. The Ogallala aquifer (which supplies water to many of the plains states in the central and southern parts of the United States) has a yearly overdraft of 160%.

In the 1950's, both the U.S.S.R and Turkey attempted to convert arid grasslands into wheat farms. In both cases, the attempts were defeated by drought and wind erosion, just as the wheat farms of Oklahoma were overcome by drought and dust in the 1930's.

If irrigation of arid lands is not performed with care, salt may be deposited, so that the land is ruined for agriculture. This type of desertification can be seen, for example, in some parts of Pakistan. Another type of desertification can be seen in the Sahel region of Africa, south of the Sahara. Rapid population growth in the Sahel has led to overgrazing, destruction of trees, and wind erosion, so that the land has become unable to support even its original population.

Especially worrying is a prediction of the International Panel on Climate Change concerning the effect of global warming on the availability of water: According to Model A1 of the IPCC, global warming may, by the 2050's, have reduced by as much as 30% the water available in large areas of world that now are large producers of grain⁴.

Added to the agricultural and environmental problems, are problems of finance and distribution. Famines can occur even when grain is available somewhere in the world, because those who are threatened with starvation may not be able to pay for the grain, or for its transportation. The economic laws of supply and demand are not able to solve this type of problem. One says that there is no "demand" for the food (meaning demand in the economic sense), even though people are in fact starving.

4.6 Energy-dependence of modern agriculture

Food prices and energy prices

A very serious problem with Green Revolution plant varieties is that they require heavy inputs of pesticides, fertilizers and irrigation. Because of this, the use of high-yield varieties contributes to social inequality, since only rich farmers can afford the necessary inputs. Monocultures, such as the Green Revolution varieties may also prove to be vulnerable to future epidemics of plant diseases, such as the epidemic that caused the Irish Potato Famine in 1845. Even more importantly, pesticides, fertilizers and irrigation all depend on the use of fossil fuels. One must therefore ask whether high agricultural yields can be maintained in the future, when fossil fuels are expected to become prohibitively scarce and expensive.

⁴See the discussion of the Stern Report in Chapter 7.

Modern agriculture has become highly dependent on fossil fuels, especially on petroleum and natural gas. This is especially true of production of the high-yield grain varieties introduced in the Green Revolution, since these require especially large inputs of fertilizers, pesticides and irrigation. Today, fertilizers are produced using oil and natural gas, while pesticides are synthesized from petroleum feedstocks, and irrigation is driven by fossil fuel energy. Thus agriculture in the developed countries has become a process where inputs of fossil fuel energy are converted into food calories. If one focuses only on the farming operations, the fossil fuel energy inputs are distributed as follows:

1. Manufacture of inorganic fertilizer, 31%
2. Operation of field machinery, 19%
3. Transportation, 16%
4. Irrigation, 13%
5. Raising livestock (not including livestock feed), 8%
6. Crop drying, 5%
7. Pesticide production, 5%
8. Miscellaneous, 8%

The ratio of the fossil fuel energy inputs to the food calorie outputs depends on how many energy-using elements of food production are included in the accounting. David Pimental and Mario Giampietro of Cornell University estimated in 1994 that U.S. agriculture required 0.7 kcal of fossil fuel energy inputs to produce 1.0 kcal of food energy. However, this figure was based on U.N. statistics that did not include fertilizer feedstocks, pesticide feedstocks, energy and machinery for drying crops, or electricity, construction and maintenance of farm buildings. A more accurate calculation, including these inputs, gives an input/output ratio of approximately 1.0. Finally, if the energy expended on transportation, packaging and retailing of food is included, Pimental and Giampietro found that the input/output ratio for the U.S. food system was approximately 10, and this figure did not include energy used for cooking.

The Brundtland Report's⁵ estimate of the global potential for food production assumes "that the area under food production can be around 1.5 billion hectares (3.7 billion acres - close to the present level), and that the average yields could go up to 5 tons of grain equivalent per hectare (as against the present average of 2 tons of grain equivalent)." In other words, the Brundtland Report assumes an increase in yields by a factor of 2.5. This would perhaps be possible if traditional agriculture could everywhere be replaced by energy-intensive modern agriculture using Green Revolution plant varieties. However, Pimental

⁵ World Commission on Environment and Development, *Our Common Future*, Oxford University Press, (1987). This book is often called "The Brundtland Report" after Gro Harlem Brundtland, the head of WCED, who was then Prime Minister of Norway.

and Giampietro's studies show that modern energy-intensive agricultural techniques cannot be maintained after fossil fuels have been exhausted.

At the time when the Brundtland Report was written (1987), the global average of 2 tons of grain equivalent per hectare included much higher yields from the sector using modern agricultural methods. Since energy-intensive petroleum-based agriculture cannot be continued in the post-fossil-fuel era, future average crop yields will probably be much less than 2 tons of grain equivalent per hectare.

The 1987 global population was approximately 5 billion. This population was supported by 3 billion tons of grain equivalent per year. After fossil fuels have been exhausted, the total world agricultural output is likely to be considerably less than that, and therefore the population that it will be possible to support will probably be considerably less than 5 billion, assuming that our average daily per capita use of food calories remains the same, and assuming that the amount of cropland and pasturage remains the same (1.5 billion hectares cropland, 3.0 billion hectares pasturage).

The Brundtland Report points out that "The present (1987) global average consumption of plant energy for food, seed and animal feed amounts to 6,000 calories daily, with a range among countries of 3,000-15,000 calories, depending on the level of meat consumption." Thus there is a certain flexibility in the global population that can survive on a given total agricultural output. If the rich countries were willing to eat less meat, more people could be supported.

4.7 Effects of climate change on agriculture

Effects of temperature increase on crops

There is a danger that when climate change causes both temperature increases and increased aridity in regions like the US grain belt, yields will be very much lowered. Of the three main grain types (corn, wheat and rice) corn is the most vulnerable to the direct effect of increases in temperature. One reason for this is the mechanism of pollination of corn: A pollen grain lands on one end of a corn-silk strand, and the germ cell must travel the length of the strand in order to fertilize the kernel. At high temperatures, the corn silk becomes dried out and withered, and is unable to fulfill its biological function. Furthermore, heat can cause the pores on the underside of the corn leaf to close, so that photosynthesis stops.

According to a study made by Mohan Wali and coworkers at Ohio State University, the photosynthetic activity of corn increases until the temperature reaches 20 degrees Celsius. It then remains constant until the temperature reaches 35 degrees, after which it declines. At 40 degrees and above, photosynthesis stops altogether.

Scientists in the Philippines report that the pollination of rice fails entirely at 40 degrees Celsius, leading to crop failures. Wheat yields are also markedly reduced by temperatures in this range.

Predicted effects on rainfall

According to the Stern Report, some of the major grain-producing areas of the world might lose up to 30% of their rainfall by 2050. These regions include much of the United States, Brazil, the Mediterranean region, Eastern Russia and Belarus, the Middle East, Southern Africa and Australia. Of course possibilities for agriculture may simultaneously increase in other regions, but the net effect of climate change on the world's food supply is predicted to be markedly negative.

Unsustainable use of groundwater

It may seem surprising that fresh water can be regarded as a non-renewable resource. However, groundwater in deep aquifers is often renewed very slowly. Sometimes renewal requires several thousand years. When the rate of withdrawal of groundwater exceeds the rate of renewal, the carrying capacity of the resource has been exceeded, and withdrawal of water becomes analogous to mining a mineral. However, it is more serious than ordinary mining because water is such a necessary support for life.

In many regions of the world today, groundwater is being withdrawn faster than it can be replenished, and important aquifers are being depleted. In China, for example, groundwater levels are falling at an alarming rate. Considerations of water supply in relation to population form the background for China's stringent population policy.

At a recent lecture, Lester Brown of the Worldwatch Institute was asked by a member of the audience to name the resource for which shortages would most quickly become acute. Most of the audience expected him to name oil, but instead he replied "water". Lester Brown then cited China's falling water table. He predicted that within decades, China would be unable to feed itself. He said that this would not cause hunger in China itself: Because of the strength of China's economy, the country would be able to purchase grain on the world market. However Chinese purchases of grain would raise the price, and put world grain out of reach of poor countries in Africa. Thus water shortages in China will produce famine in parts of Africa, Brown predicted.

Under many desert areas of the world are deeply buried water tables formed during glacial periods when the climate of these regions was wetter. These regions include the Middle East and large parts of Africa. Water can be withdrawn from such ancient reservoirs by deep wells and pumping, but only for a limited amount of time.

In oil-rich Saudi Arabia, petroenergy is used to drill wells for ancient water and to bring it to the surface. Much of this water is used to irrigate wheat fields, and this is done to such an extent that Saudi Arabia exports wheat. The country is, in effect, exporting its ancient heritage of water, a policy that it may, in time, regret. A similarly short-sighted project is Muammar Qaddafi's enormous pipeline, which will bring water from ancient sub-desert reservoirs to coastal cities of Libya.

In the United States, the great Ogallala aquifer is being overdrawn. This aquifer is an enormous stratum of water-saturated sand and gravel underlying parts of northern Texas, Oklahoma, New Mexico, Kansas, Colorado, Nebraska, Wyoming and South Dakota. The



Figure 4.5: **Whitechuck Glacier in the North Cascades National Park in 1973.** (Nicholas College)



Figure 4.6: **The same glacier in 2006** (Nicholas College)

average thickness of the aquifer is about 70 meters. The rate of water withdrawal from the aquifer exceeds the rate of recharge by a factor of eight.

Thus we can see that in many regions, the earth's present population is living on its inheritance of water, rather than its income. This fact, coupled with rapidly increasing populations and climate change, may contribute to a food crisis partway through the 21st century.

Glacial melting and summer water supplies

The summer water supplies of both China and India are threatened by the melting of glaciers. The Gangotri glacier, which is the principle glacier feeding India's great Ganges River, is reported to be melting at an accelerating rate, and it could disappear within a few decades. If this happens, the Ganges could become seasonal, flowing only during the

monsoon season.

Chinese agriculture is also threatened by disappearing Himalayan glaciers, in this case those on the Tibet-Quinghai Plateau. The respected Chinese glaciologist Yao Tandong estimates that the glaciers feeding the Yangtze and Yellow Rivers are disappearing at the rate of 7% per year.

The Indus and Mekong Rivers will be similarly affected by the melting of glaciers. Lack of water during the summer season could have a serious impact on the irrigation of rice and wheat fields.

Forest loss and climate change

Mature forests contain vast amounts of sequestered carbon, not only in their trees, but also in the carbon-rich soil of the forest floor. When a forest is logged or burned to make way for agriculture, this carbon is released into the atmosphere. One fifth of the global carbon emissions are at present due to destruction of forests. This amount is greater than the CO₂ emissions for the world's transportation systems.

An intact forest pumps water back into the atmosphere, increasing inland rainfall and benefiting agriculture. By contrast, deforestation, for example in the Amazonian rainforest, accelerates the flow of water back into the ocean, thus reducing inland rainfall. There is a danger that the Amazonian rainforest may be destroyed to such an extent that the region will become much more dry. If this happens, the forest may become vulnerable to fires produced by lightning strikes. This is one of the feedback loops against which the Stern Report warns - the drying and burning of the Amazonian rainforest may become irreversible, greatly accelerating climate change, if destruction of the forest proceeds beyond a certain point.

Erosion of topsoil

Besides depending on an adequate supply of water, food production also depends on the condition of the thin layer of topsoil that covers the world's croplands. This topsoil is being degraded and eroded at an alarming rate: According to the World Resources Institute and the United Nations Environment Programme, "It is estimated that since World War II, 1.2 billion hectares... has suffered at least moderate degradation as a result of human activity. This is a vast area, roughly the size of China and India combined." This area is 27% of the total area currently devoted to agriculture ⁶. The report goes on to say that the degradation is greatest in Africa.

The risk of topsoil erosion is greatest when marginal land is brought into cultivation, since marginal land is usually on steep hillsides which are vulnerable to water erosion when wild vegetation is removed.

David Pimental and his associates at Cornell University pointed out in 1995 that "Because of erosion-associated loss of productivity and population growth, the per capita food

⁶The total area devoted to agriculture throughout the world is 1.5 billion hectares of cropland and 3.0 billion hectares of pasturage.

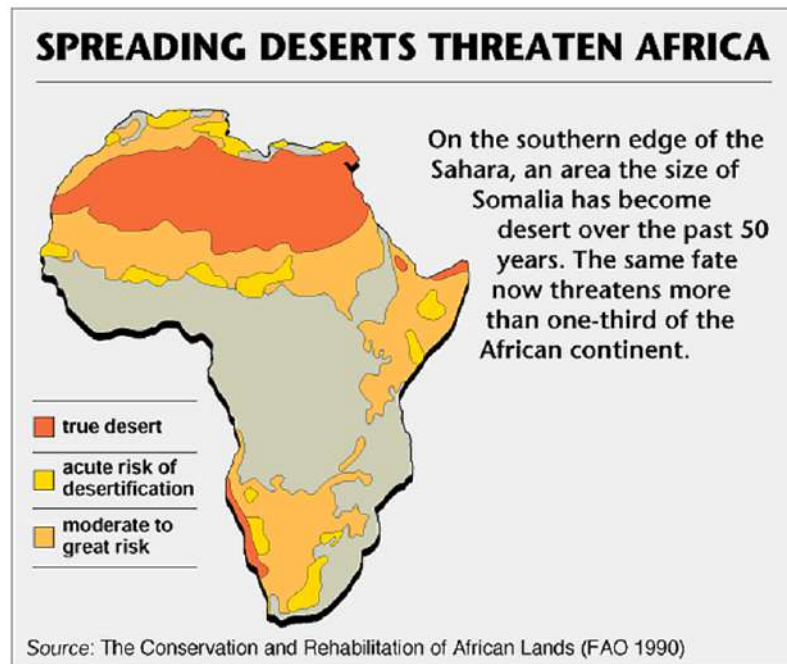

Figure 4.7: Desert regions of the Africa that are in danger of spreading. (FAO)

supply has been reduced over the past 10 years and continues to fall. The Food and Agricultural Organization reports that the per capita production of grains which make up 80% of the world's food supply, has been declining since 1984."

Pimental et al. add that "Not only is the availability of cropland per capita decreasing as the world population grows, but arable land is being lost due to excessive pressure on the environment. For instance, during the past 40 years nearly one-third of the world's cropland (1.5 billion hectares) has been abandoned because of soil erosion and degradation. Most of the replacement has come from marginal land made available by removing forests. Agriculture accounts for 80% of the annual deforestation."

Topsoil can also be degraded by the accumulation of salt when irrigation water evaporates. The worldwide area of irrigated land has increased from 8 million hectares in 1800 to more than 100 million hectares today. This land is especially important to the world food supply because it is carefully tended and yields are large in proportion to the area. To protect this land from salination, it should be irrigated in such a way that evaporation is minimized.

Finally cropland with valuable topsoil is being be lost to urban growth and highway development, a problem that is made more severe by growing populations and by economic growth.

Laterization

Every year, more than 100,000 square kilometers of rain forest are cleared and burned, an area which corresponds to that of Switzerland and the Netherlands combined. Almost half of the world's tropical forests have already been destroyed. Ironically, the land thus cleared often becomes unsuitable for agriculture within a few years.

Tropical soils may seem to be fertile when covered with luxuriant vegetation, but they are usually very poor in nutrients because of leeching by heavy rains. The nutrients which remain are contained in the vegetation itself; and when the forest cover is cut and burned, the nutrients are rapidly lost.

Often the remaining soil is rich in aluminum oxide and iron oxide. When such soils are exposed to oxygen and sun-baking, a rocklike substance called Laterite is formed. The temples of Angkor Wat in Cambodia are built of Laterite; and it is thought that laterization of the soil contributed to the disappearance of the Khmer civilization, which built these temples.

4.8 Harmful effects of industrialized farming

A major global public health crisis may soon be produced by the wholesale use of antibiotics in the food of healthy farm animals. The resistance factors produced by shovelling antibiotics into animal food produces resistance factors (plasmids) which can easily be transferred to human pathogens. A related problem is the excessive use of pesticides and artificial fossil-fuel-derived fertilizers in agriculture. Pharming is not a joke. It is a serious threat.⁷

Plasmids

Bacteria belong to a class of organisms (prokaryotes) whose cells do not have a nucleus. Instead, the DNA of the bacterial chromosome is arranged in a large loop. In the early 1950's, Joshua Lederberg discovered that bacteria can exchange genetic information. He found that a frequently-exchanged gene, the F-factor (which conferred fertility), was not linked to other bacterial genes; and he deduced that the DNA of the F-factor was not physically a part of the main bacterial chromosome. In 1952, Lederberg coined the word "plasmid" to denote any extrachromosomal genetic system.

⁷<http://ecowatch.com/2014/03/06/misuse-antibiotics-fatal-superbug-crisis/>
<http://ecowatch.com/2013/12/06/8-scary-facts-about-antibiotic-resistance/>
<http://ecowatch.com/2015/03/27/obama-fight-superbug-crisis/>
<http://ecowatch.com/2014/03/12/fda-regulation-antibiotics-factory-farms/>
<http://www.bbc.com/news/health-35153795>
<http://www.bbc.com/news/health-21702647>
<http://www.bbc.com/news/health-34857015>
<http://sustainableagriculture.net/about-us/>
<https://pwccc.wordpress.com/programa/>

In 1959, it was discovered in Japan that genes for resistance to antibiotics can be exchanged between bacteria; and the name “R-factors” was given to these genes. Like the F-factors, the R-factors did not seem to be part of the main loop of bacterial DNA.

Because of the medical implications of this discovery, much attention was focused on the R-factors. It was found that they were plasmids, small loops of DNA existing inside the bacterial cell, but not attached to the bacterial chromosome. Further study showed that, in general, between one percent and three percent of bacterial genetic information is carried by plasmids, which can be exchanged freely even between different species of bacteria.

In the words of the microbiologist, Richard Novick, “Appreciation of the role of plasmids has produced a rather dramatic shift in biologists’ thinking about genetics. The traditional view was that the genetic makeup of a species was about the same from one cell to another, and was constant over long periods of time. Now a significant proportion of genetic traits are known to be variable (present in some individual cells or strains, absent in others), labile (subject to frequent loss or gain) and mobile, all because those traits are associated with plasmids or other atypical genetic systems.”

Because of the ease with which plasmids conferring resistance to antibiotics can be transferred from animal bacteria to the bacteria carrying human disease, the practice of feeding antibiotics to healthy farm animals is becoming a major human health hazard. The World Health Organization has warned that if we lose effective antibiotics through this mechanism, “Many common infections will no longer have a cure, and could kill unabated”. The US Center for Disease Control has pointed to the emergence of “nightmare bacteria”, and the chief medical officer for England Prof Dame Sally Davies has evoked parallels with the “apocalypse”.

Pesticides, artificial fertilizers and topsoil

A closely analogous danger results from the overuse of pesticides and petroleum-derived fertilizers in agriculture. A very serious problem with Green Revolution plant varieties is that they require heavy inputs of pesticides, fertilizers and irrigation. Because of this, the use of high-yield varieties contributes to social inequality, since only rich farmers can afford the necessary inputs. Monocultures, such as the Green Revolution varieties may also prove to be vulnerable to future plant diseases, such as the epidemic that caused the Irish Potato Famine in 1845. Even more importantly, pesticides, fertilizers and irrigation all depend on the use of fossil fuels. One must ask, therefore, whether high-yield agriculture can be maintained in the post-fossil-fuel era.

Topsoil is degraded by excessive use of pesticides and artificial fertilizers. Natural topsoil is rich in organic material, which contains sequestered carbon that would otherwise be present in our atmosphere in the form of greenhouse gases. In addition, natural topsoil contains an extraordinarily rich diversity of bacteria and worms that act to convert agricultural wastes from one year’s harvest into nutrients for the growth of next year’s crop. Pesticides kill these vital organisms, and make the use of artificial fertilizers necessary.

Finally, many small individual farmers, whose methods are sustainable, are being eliminated by secret land-grabs or put out of business because they cannot compete with unsustainable high-yield agriculture. Traditional agriculture contains a wealth of knowledge and biodiversity, which it would be wise for the world to preserve.

4.9 The demographic transition

The phrase “developing countries” is more than a euphemism; it expresses the hope that with the help of a transfer of technology from the industrialized nations, all parts of the world can achieve prosperity. Some of the forces that block this hope have just been mentioned. Another factor that prevents the achievement of worldwide prosperity is population growth.

In the words of Dr. Halfdan Mahler, former Director General of the World Health Organization, “Country after country has seen painfully achieved increases in total output, food production, health and educational facilities and employment opportunities reduced or nullified by excessive population growth.”

The growth of population is linked to excessive urbanization, infrastructure failures and unemployment. In rural districts in the developing countries, family farms are often divided among a growing number of heirs until they can no longer be subdivided. Those family members who are no longer needed on the land have no alternative except migration to overcrowded cities, where the infrastructure is unable to cope so many new arrivals. Often the new migrants are forced to live in excrement-filled makeshift slums, where dysentery, hepatitis and typhoid are endemic, and where the conditions for human life sink to the lowest imaginable level. In Brazil, such shanty towns are called “favelas”.

If modern farming methods are introduced in rural areas while population growth continues, the exodus to cities is aggravated, since modern techniques are less labor-intensive and favor large farms. In cities, the development of adequate infrastructure requires time, and it becomes a hopeless task if populations are growing rapidly. Thus, population stabilization is a necessary first step for development.

It can be observed that birth rates fall as countries develop. However, development is sometimes blocked by the same high birth rates that economic progress might have prevented. In this situation (known as the “demographic trap”), economic gains disappear immediately because of the demands of an exploding population.

For countries caught in the demographic trap, government birth control programs are especially important, because one cannot rely on improved social conditions to slow birth rates. Since health and lowered birth rates should be linked, it is appropriate that family-planning should be an important part of programs for public health and economic development.

A recent study conducted by Robert F. Lapham of Demographic Health Surveys and W. Parker Maudlin of the Rockefeller Foundation has shown that the use of birth control is correlated both with socio-economic setting and with the existence of strong family-planning programs. The implication of this study is that even in the absence of increased

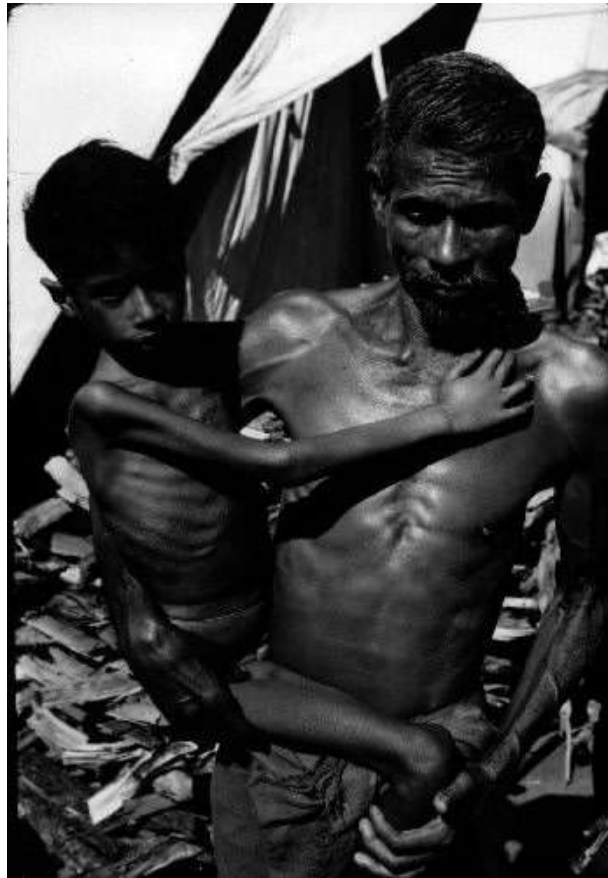

Figure 4.8: **Child suffering with the deficiency disease Marasmus in India.** (Public domain)



Figure 4.9: **Education of women and higher status for women are vitally important measures, not only for their own sake, but also because these social reforms have proved to be the key to lower birth rates.** (Kundan Srivastava)

living standards, family-planning programs can be successful, provided they have strong government support.

China, the world's most populous nation, has adopted the somewhat draconian policy of allowing only one child for families in living in towns and cities (35.9% of the population). Chinese leaders obtained popular support for their one-child policy by means of an educational program which emphasized future projections of diminishing water resources and diminishing cropland per person if population increased unchecked. Like other developing countries, China has a very young population, which will continue to grow even when fertility has fallen below the replacement level because so many of its members are contributing to the birth rate rather than to the death rate. China's present population is 1.3 billion. Its projected population for the year 2025 is 1.5 billion. China's one-child policy is supported by 75% of the country's people, but the methods of enforcement are sometimes criticized, and it has led to a M/F sex ratio of 1.17/1.00. The natural baseline for the sex ratio ranges between 1.03/1.00 and 1.07/1.00.

Education of women and higher status for women are vitally important measures, not only for their own sake, but also because in many countries these social reforms have proved to be the key to lower birth rates. Religious leaders who oppose programs for the education of women and for family planning on "ethical" grounds should think carefully about the scope and consequences of the catastrophic global famine which will undoubtedly occur within the next 50 years if population is allowed to increase unchecked. Do these leaders really wish to be responsible for the suffering and death from starvation of hundreds of millions of people?

At the United Nations Conference on Population and Development, held in Cairo in September, 1994, a theme which emerged very clearly was that one of the most important

keys to controlling the global population explosion is giving women better education and equal rights. These goals are desirable for the sake of increased human happiness, and for the sake of the uniquely life-oriented point of view which women can give us; but in addition, education and improved status for women have shown themselves to be closely connected with lowered birth rates. When women lack education and independent careers outside the home, they can be forced into the role of baby-producing machines by men who do not share in the drudgery of cooking, washing and cleaning; but when women have educational, legal, economic, social and political equality with men, experience has shown that they choose to limit their families to a moderate size.

Sir Partha Dasgupta of Cambridge University has pointed out that the changes needed to break the cycle of overpopulation and poverty are all desirable in themselves. Besides education and higher status for women, they include state-provided social security for old people, provision of water supplies near to dwellings, provision of health services to all, abolition of child labor and general economic development.

The UN Summit on Addressing Large Movements of Refugees and Migrants

On September 19, 2016, the United Nations General Assembly held a 1-day summit meeting to address the pressing problem of refugees. It is a problem that has been made acute by armed conflicts in the Middle East and Africa, and by climate change.

One of the outcomes of the summit was the a Declaration for Refugees and Migrants. Here is a statement of the severity of the problem from paragraph 3 of the Declaration:

“We are witnessing in today’s world an unprecedented level of human mobility. More people than ever before live in a country other than the one in which they were born. Migrants are present in all countries of the world. Most of them move without incident. In 2015, their number surpassed 244 million, growing at a rate faster than the world’s population. However, there are 65 million forcibly displaced persons, including over 21 million refugees, 3 million asylum seekers and over 40 million internally displaced persons.”

Sadly, the world’s response to the tragic plight of refugees fleeing from zones of armed conflict has been less than generous. Men, women and many children, trying to escape from almost certain death in the war-torn Middle East, have been met, not with sympathy and kindness, but with barbed wire and tear gas.

Germany’s Chancellor, Angela Merkel, courageously made arrangements for her country to accept a large number of refugees, but as a consequence her party has suffered political setbacks. On the whole, European governments have moved to the right, as anti-refugee parties gained strength. The United States, Canada Australia and Russia, countries that could potentially save the lives of many refugees, have accepted almost none. In contrast, tiny Lebanon, despite all its problems, has become the home of so many refugees that they are a very large fraction of the country’s total population.

As the effects of climate change become more pronounced, we can expect the suffering and hopelessness of refugees to become even more severe. This is a challenge which the

world must meet with humanity and solidarity.

The World Cities Report, 2016

According to the World Cities Report⁸, by 2030, two thirds of the world's population will be living in cities. As the urban population increases, the land area occupied by cities is increasing at a higher rate. It is projected that by 2030, the urban population of developing countries will double, while the area covered by cities could triple.

Commenting on this, the UN-Habitat Executive Director, Joan Clos, said: "In the twenty years since the Habitat II conference, the world has seen a gathering of its population in urban areas. This has been accompanied by socioeconomic growth in many instances. But the urban landscape is changing and with it, the pressing need for a cohesive and realistic approach to urbanization".

"Such urban expansion is wasteful in terms of land and energy consumption and increases greenhouse gas emissions. The urban centre of gravity, at least for megacities, has shifted to the developing regions."

One can foresee that in the future, as fossil fuels become increasingly scarce, the problem of feeding urban populations will become acute.

Suggestions for further reading

1. P. Dasgupta, *Population, Resources and Poverty*, *Ambio*, **21**, 95-101, (1992).
2. L.R. Brown, *Who Will Feed China?*, W.W. Norton, New York, (1995).
3. L.R. Brown, et al., *Saving the Planet. How to Shape and Environmentally Sustainable Global Economy*, W.W. Norton, New York, (1991).
4. L.R. Brown, *Postmodern Malthus: Are There Too Many of Us to Survive?*, *The Washington Post*, July 18, (1993).
5. L.R. Brown and H. Kane, *Full House. Reassessing the Earth's Population Carrying Capacity*, W.W. Norton, New York, (1991).
6. L.R. Brown, *Seeds of Change*, Praeger Publishers, New York, (1970).
7. L.R. Brown, *The Worldwide Loss of Cropland*, Worldwatch Paper 24, Worldwatch Institute, Washington, D.C., (1978).
8. L.R. Brown, and J.L. Jacobson, *Our Demographically Divided World*, Worldwatch Paper 74, Worldwatch Institute, Washington D.C., (1986).
9. L.R. Brown, and J.L. Jacobson, *The Future of Urbanization: Facing the Ecological and Economic Constraints*, Worldwatch Paper 77, Worldwatch Institute, Washington D.C., (1987).
10. L.R. Brown, and others, *State of the World*, W.W. Norton, New York, (published annually).
11. H. Brown, *The Human Future Revisited. The World Predicament and Possible Solutions*, W.W. Norton, New York, (1978).

⁸<http://wcr.unhabitat.org/>

12. H. Hanson, N.E. Borlaug and N.E. Anderson, *Wheat in the Third World*, Westview Press, Boulder, Colorado, (1982).
13. A. Dil, ed., *Norman Borlaug and World Hunger*, Bookservice International, San Diego/Islamabad/Lahore, (1997).
14. N.E. Borlaug, *The Green Revolution Revisited and the Road Ahead*, Norwegian Nobel Institute, Oslo, Norway, (2000).
15. N.E. Borlaug, *Ending World Hunger. The Promise of Biotechnology and the Threat of Antiscience Zealotry*, *Plant Physiology*, **124**, 487-490, (2000).
16. M. Giampietro and D. Pimental, *The Tightening Conflict: Population, Energy Use and the Ecology of Agriculture*, in *Negative Population Forum*, L. Grant ed., Negative Population Growth, Inc., Teaneck, N.J., (1993).
17. H.W. Kendall and D. Pimental, *Constraints on the Expansion of the Global Food Supply*, *Ambio*, **23**, 198-2005, (1994).
18. D. Pimental et al., *Natural Resources and Optimum Human Population*, *Population and Environment*, **15**, 347-369, (1994).
19. D. Pimental et al., *Environmental and Economic Costs of Soil Erosion and Conservation Benefits*, *Science*, **267**, 1117-1123, (1995).
20. D. Pimental et al., *Natural Resources and Optimum Human Population*, *Population and Environment*, **15**, 347-369, (1994).
21. D. Pimental and M. Pimental, *Food Energy and Society*, University Press of Colorado, Niwot, Colorado, (1996).
22. D. Pimental et al., *Environmental and Economic Costs of Soil Erosion and Conservation Benefits*, *Science*, **267**, 1117-1123, (1995).
23. RS and NAS, *The Royal Society and the National Academy of Sciences on Population Growth and Sustainability*, *Population and Development Review*, **18**, 375-378, (1992).
24. A.M. Altieri, *Agroecology: The Science of Sustainable Agriculture*, Westview Press, Boulder, Colorado, (1995).
25. G. Conway, *The Doubly Green Revolution*, Cornell University Press, (1997).
26. J. Dreze and A. Sen, *Hunger and Public Action*, Oxford University Press, (1991).
27. G. Bridger, and M. de Soissons, *Famine in Retreat?*, Dent, London, (1970).
28. W. Brandt, *World Armament and World Hunger: A Call for Action*, Victor Gollanz Ltd., London, (1982).
29. A.K.M.A. Chowdhury and L.C. Chen, *The Dynamics of Contemporary Famine*, Ford Foundation, Dacca, Pakistan, (1977)
30. J. Shepard, *The Politics of Starvation*, Carnegie Endowment for International Peace, Washington D.C., (1975).
31. M.E. Clark, *Ariadne's Thread: The Search for New Modes of Thinking*, St. Martin's Press, New York, (1989).
32. J.-C. Chesnais, *The Demographic Transition*, Oxford, (1992).
33. C.M. Cipola, *The Economic History of World Population*, Penguin Books Ltd., (1974).
34. E. Draper, *Birth Control in the Modern World*, Penguin Books, Ltd., (1972).

35. Draper Fund Report No. 15, *Towards Smaller Families: The Crucial Role of the Private Sector*, Population Crisis Committee, 1120 Nineteenth Street, N.W., Washington D.C. 20036, (1986).
36. E. Eckholm, *Losing Ground: Environmental Stress and World Food Prospects*, W.W. Norton, New York, (1975).
37. E. Havemann, *Birth Control*, Time-Life Books, (1967).
38. J. Jacobsen, *Promoting Population Stabilization: Incentives for Small Families*, Worldwatch Paper 54, Worldwatch Institute, Washington D.C., (1983).
39. N. Keyfitz, *Applied Mathematical Demography*, Wiley, New York, (1977).
40. W. Latz (ed.), *Future Demographic Trends*, Academic Press, New York, (1979).
41. World Bank, *Poverty and Hunger: Issues and Options for Food Security in Developing Countries*, Washington D.C., (1986).
42. J.E. Cohen, *How Many People Can the Earth Support?*, W.W. Norton, New York, (1995).
43. J. Amos, *Climate Food Crisis to Deepen*, BBC News (5 September, 2005).
44. J. Vidal and T. Ratford, *One in Six Countries Facing Food Shortage*, The Guardian, (30 June, 2005).
45. J. Mann, *Biting the Environment that Feeds Us*, The Washington Post, July 29, 1994.
46. G.R. Lucas, Jr., and T.W. Ogletree, (editors), *Lifeboat Ethics. The Moral Dilemmas of World Hunger*, Harper and Row, New York.
47. J.L. Jacobson, *Gender Bias: Roadblock to Sustainable Development*, Worldwatch Paper 110, Worldwatch Institute, Washington D.C., (1992).
48. J. Gever, R. Kaufmann, D. Skole and C. Vorosmarty, *Beyond Oil: The Threat to Food and Fuel in the Coming Decades*, Ballinger, Cambridge MA, (1986).
49. M. ul Haq, *The Poverty Curtain: Choices for the Third World*, Columbia University Press, New York, (1976).
50. H. Le Bras, *La Planète au Village*, Datar, Paris, (1993).
51. E. Mayr, *Population, Species and Evolution*, Harvard University Press, Cambridge, (1970).

Chapter 5

THE GLOBAL REFUGEE CRISIS

5.1 People fleeing from wars and climate change

The number of refugees from both conflicts and climate change is increasing rapidly. Several million refugees have fled from wars in the Middle East. Meanwhile, drought and rising temperatures in Africa have also produced millions of refugees, anxious for a better life in Europe. Similarly, in the western hemisphere, both conflicts and climate change have produced a stream of desperate people, traveling through Mexico to the southern borders of the United States. There they have been treated in an extremely cruel way by the Trump administration. Young children, infants, have been separated from their parents and put into cages.

5.2 A UN ruling on climate refugees

Here is an excerpt from an article entitled *UN Landmark Case for People Displaced By Climate Change*, published by Amnesty International on Monday, January 20, 2020:

In a ground-breaking asylum case, a UN human rights body has ruled that governments must take into account the human rights violations caused by the climate crisis when considering deportation of asylum seekers, said Amnesty International today.

“The decision sets a global precedent,” said Kate Schuetze, Pacific Researcher at Amnesty International. “It says a state will be in breach of its human rights obligations if it returns someone to a country where - due to the climate crisis - their life is at risk, or in danger of cruel, inhuman or degrading treatment.”



Figure 5.1: A starving child in Somalia.

5.3 Climate change as genocide

Climate change does not affect all parts of the world equally. The harshest effects of the extreme weather that we are already experiencing are disproportionately felt by the poorest people of the world.

In March, 2017, the Security Council was informed ¹ that 20 million people in four countries, Nigeria, Somalia, South Sudan and Yemen, were in danger of dying unless provided with immediate help. The cost of the necessary aid was estimated to be \$4.4 billion. The developed world's response has been a shrug of indifference. By the midsummer, 2017 only a tenth of the amount needed had been raised.

Conflicts and famine are interlinked. The struggle for food produces conflicts; and famine is often used as an instrument of war. Food aid, when available, is often deliberately blocked or destroyed by warring factions. Boko Haram in Nigeria, al-Shabaab in Somalia, assorted militias and the government in South Sudan, and Saudi-backed forces in Yemen all interfered with the delivery of aid supplies.

In the future, the effects of rising temperatures and reduced rainfall will disproportionately affect poor farmers of Africa, the Middle East, South Asia, and Latin America. If the more affluent parts of the world continue to produce greenhouse gasses in a business-as-usual scenario, and if they continue to ignore calls for help from starving people, these actions will amount to genocide.

¹by Stephen O'Brian, UN Under Secretary General for Humanitarian Affairs

5.4 The United Nations High Commission on Refugees

In an article on *Climate Change and Disasters* the United Nations High Commission on Refugees makes the following statement:

“The Earth’s climate is changing at a rate that has exceeded most scientific forecasts. Some families and communities have already started to suffer from disasters and the consequences of climate change, forced to leave their homes in search of a new beginning.

“For UNHCR, the consequences of climate change are enormous. Scarce natural resources such as drinking water are likely to become even more limited. Many crops and some livestock are unlikely to survive in certain locations if conditions become too hot and dry, or too cold and wet. Food security, already a concern, will become even more challenging.

“People try to adapt to this situation, but for many this will mean a conscious move to another place to survive. Such moves, or the effects of climate change on natural resources, may spark conflict with other communities, as an increasing number of people compete for a decreasing amount of resources.

“Since 2009, an estimated one person every second has been displaced by a disaster, with an average of 22.5 million people displaced by climate- or weather-related events since 2008 (IDMC 2015). Disasters and slow onsets, such as droughts in Somalia in 2011 and 2012, floods in Pakistan between 2010 and 2012, and the earthquake in Nepal in 2015, can leave huge numbers of people traumatized without shelter, clean water and basic supplies.”

5.5 Populations displaced by sea level rise

In a recent article² discussed the long-term effects of sea level rise and the massive refugee crisis that it might create. By 2060, about 1.4 billion people could be climate change refugees, according to the paper, and that number could reach 2 billion by 2100.

The lead author, Prof. Emeritus Charles Geisler of Cornell University says: “The colliding forces of human fertility, submerging coastal zones, residential retreat, and impediments to inland resettlement is a huge problem. We offer preliminary estimates of the lands unlikely to support new waves of climate refugees due to the residues of war, exhausted natural resources, declining net primary productivity, desertification, urban sprawl, land concentration, ‘paving the planet’ with roads and greenhouse gas storage zones offsetting permafrost melt.”

We should notice that Prof. Geisler’s estimate of 2 billion climate refugees by 2100 includes all causes, not merely sea level rise. However, the number of refugees from sea level rise alone will be very large, since all the world’s coastal cities, and many river deltas will be at risk.

²Geisler C. et al., *Impediments to inland resettlement under conditions of accelerated sea level rise*, Land Use Policy, Vol 55, July 2017, Pages 322-330

5.6 Populations displaced by drought and famine

Climate change could produce a refugee crisis that is "unprecedented in human history", Barack Obama has warned as he stressed global warming was the most pressing issue of the age.

Speaking at an international food conference in Milan, the former US President said rising temperatures were already making it more difficult to grow crops and rising food prices were "leading to political instability".

If world leaders put aside "parochial interests" and took action to reduce greenhouse gas emissions by enough to restrict the rise to one or two degrees Celsius, then humanity would probably be able to cope.

Failing to do this, Mr Obama warned, increased the risk of "catastrophic" effects in the future, "not only real threats to food security, but also increases in conflict as a consequence of scarcity and greater refugee and migration patterns".

"If you think about monsoon patterns in the Indian subcontinent, maybe half a billion people rely on traditional rain patterns in those areas,"

5.7 Populations displaced by rising temperatures

A new study published in Nature: Climate Change has warned that up to 75% of the world's population could face deadly heat waves by 2100 unless greenhouse gas emissions are rapidly controlled.³ The following is an excerpt from the article:

"Here we conducted a global analysis of documented lethal heat events to identify the climatic conditions associated with human death and then quantified the current and projected occurrence of such deadly climatic conditions worldwide. We reviewed papers published between 1980 and 2014, and found 783 cases of excess human mortality associated with heat from 164 cities in 36 countries.

"Based on the climatic conditions of those lethal heat events, we identified a global threshold beyond which daily mean surface air temperature and relative humidity become deadly. Around 30% of the world's population is currently exposed to climatic conditions exceeding this deadly threshold for at least 20 days a year.

"By 2100, this percentage is projected to increase to 48% under a scenario with drastic reductions of greenhouse gas emissions and 74% under a scenario of growing emissions. An increasing threat to human life from excess heat now seems almost inevitable, but will be greatly aggravated if greenhouse gases are not considerably reduced."⁴

³Mora, C. et al., *Global risk of deadly heat*, Nature: Climate Change, 19 June 2017

⁴See also <https://phys.org/news/2017-08-deadly-south-asia-century.html> and <https://cleantechnica.com/2017/09/28/extreme-heatwaves-like-recent-lucifer-heatwave-become-normal-europe-2050s/>

5.8 Populations displaced by war

A recent article in *The Guardian*⁵ discusses the relationship between climate change and war, Here are some excerpts from the article:

“Climate change is set to cause a refugee crisis of ‘unimaginable scale’, according to senior military figures, who warn that global warming is the greatest security threat of the 21st century and that mass migration will become the ‘new normal’.

“The generals said the impacts of climate change were already factors in the conflicts driving a current crisis of migration into Europe, having been linked to the Arab Spring, the war in Syria and the Boko Haram terrorist insurgency.

“Military leaders have long warned that global warming could multiply and accelerate security threats around the world by provoking conflicts and migration. They are now warning that immediate action is required.

“Climate change is the greatest security threat of the 21st century,’ said Maj Gen Muniruzzaman.

“Muniruzzaman, chairman of the Global Military Advisory Council on climate change and a former military adviser to the president of Bangladesh. He said one meter of sea level rise will flood 20% of his nation. ‘We’re going to see refugee problems on an unimaginable scale, potentially above 30 million people.’

“Previously, Bangladesh’s finance minister, Abul Maal Abdul Muhith, called on Britain and other wealthy countries to accept millions of displaced people.

“Brig Gen Stephen Cheney, a member of the US Department of State’s foreign affairs policy board and CEO of the American Security Project, said: ‘Climate change could lead to a humanitarian crisis of epic proportions. We’re already seeing migration of large numbers of people around the world because of food scarcity, water insecurity and extreme weather, and this is set to become the new normal’.

5.9 Political reactions to migration

Brexit

Across the developed world, the reaction to threatened migration of refugees from climate change has been less than generous, to say the least. The recent decision of Britain to leave the European Union was motivated largely by the fear of British workers that EU laws would force their country to accept large numbers of refugees.

Swings to the right in Europe

In Germany, Angela Merkel’s generous policies towards refugees have cost her votes, while an openly racist party, the Alternative for Germany (AfD) party, has gained in strength. Frauke Petry, 40, the party’s leader, has said border guards might need to turn guns on

⁵Thursday, 1 December, 2016

anyone crossing a frontier illegally. The party's policy platform says "Islam does not belong in Germany" and calls for a ban on the construction of mosques.

In September, 2017, eight people from the neo-Nazi Freital Group were put on trial in Dresden for bomb attacks on homes for asylum applicants. Hundreds of similar assaults occur in Germany every year, but they had never before been tried as terrorism in a federal court.

In the German election, which took place on Sunday, October 1, 2017, Angela Merkel won a fourth term as Chancellor, but her party won only 33% of the votes, a percentage much reduced from the 41% won in the election of 2013. Angela Merkel was paying a high price for her refugee-friendly policies.

Meanwhile the far right anti-immigration AfD party made a historic breakthrough, winning 13.5% of the vote, thus becoming the first overtly nationalist party to sit in the Bundestag in 60 years. The Greens have already complained that "Nazis have returned to parliament". In fact, members of the AfD party have begun to say that Germans should stop being ashamed of their country's Nazi past.

In France, the National Front is a nationalist party that uses populist rhetoric to promote its anti-immigration and anti-European Union positions. The party favors protectionist economic policies and would clamp down on government benefits for immigrants.

Similarly, in the Netherlands, the anti-European Union, anti-Islam Party for Freedom has called for closing all Islamic schools and recording the ethnicity of all Dutch citizens. In early November, the party was leading in polls ahead of next year's parliamentary elections.

Other far-right anti-immigrant parties in Europe include Golden Dawn (Greece), Jobbic (Hungary), Sweden Democrats (Sweden), Freedom Party (Austria), and People's Party - Our Slovakia (Slovakia). All of these parties have gained in strength because of the widespread fear of immigration.

Populism in the United States

The election of Donald Trump, who ran for President in 2016 on an openly racist and anti-immigrant platform, can also be seen as the result of fear of immigration, especially on the part of industrial workers.

5.10 A more humane response to the refugee crisis

In the long-term future, climate change will make the refugee crisis much more severe. Heat and drought will make large regions of the world uninhabitable, and will threaten many populations with famine. The severity of the refugee crisis will depend on how quickly we reduce greenhouse gas emissions.

While making many parts of the world uninhabitable, long-term climate change will make other regions more suitable for human habitation and agriculture. For example,

farming will become more possible in Siberia, Greenland, the Canadian Arctic, Alaska and Patagonia. A humane response to the refugee crisis could include the generous opening of these regions to refugees.

The global population of humans is currently increasing by almost a billion people every decade. Global population must be stabilized, and in the long run, gradually reduced. Money currently wasted (or worse than wasted) on armaments could be used instead to promote universal primary health care, and with it, universal access to the knowledge and materials needed for family planning.

Finally, reduced consumption of meat, particularly beef, would shorten the food chain thus make more food available for famine relief.

Suggestions for further reading

1. P. Dasgupta, *Population, Resources and Poverty*, *Ambio*, **21**, 95-101, (1992).
2. L.R. Brown, *Who Will Feed China?*, W.W. Norton, New York, (1995).
3. L.R. Brown, et al., *Saving the Planet. How to Shape and Environmentally Sustainable Global Economy*, W.W. Norton, New York, (1991).
4. L.R. Brown, *Postmodern Malthus: Are There Too Many of Us to Survive?*, *The Washington Post*, July 18, (1993).
5. L.R. Brown and H. Kane, *Full House. Reassessing the Earth's Population Carrying Capacity*, W.W. Norton, New York, (1991).
6. L.R. Brown, *Seeds of Change*, Praeger Publishers, New York, (1970).
7. L.R. Brown, *The Worldwide Loss of Cropland*, Worldwatch Paper 24, Worldwatch Institute, Washington, D.C., (1978).
8. L.R. Brown, and J.L. Jacobson, *Our Demographically Divided World*, Worldwatch Paper 74, Worldwatch Institute, Washington D.C., (1986).
9. L.R. Brown, and J.L. Jacobson, *The Future of Urbanization: Facing the Ecological and Economic Constraints*, Worldwatch Paper 77, Worldwatch Institute, Washington D.C., (1987).
10. L.R. Brown, and others, *State of the World*, W.W. Norton, New York, (published annually).
11. H. Brown, *The Human Future Revisited. The World Predicament and Possible Solutions*, W.W. Norton, New York, (1978).
12. H. Hanson, N.E. Borlaug and N.E. Anderson, *Wheat in the Third World*, Westview Press, Boulder, Colorado, (1982).
13. A. Dil, ed., *Norman Borlaug and World Hunger*, Bookservice International, San Diego/Islamabad/Lahore, (1997).
14. N.E. Borlaug, *The Green Revolution Revisited and the Road Ahead*, Norwegian Nobel Institute, Oslo, Norway, (2000).
15. N.E. Borlaug, *Ending World Hunger. The Promise of Biotechnology and the Threat of Antiscience Zealotry*, *Plant Physiology*, **124**, 487-490, (2000).

16. M. Giampietro and D. Pimental, *The Tightening Conflict: Population, Energy Use and the Ecology of Agriculture*, in *Negative Population Forum*, L. Grant ed., Negative Population Growth, Inc., Teaneck, N.J., (1993).
17. H.W. Kendall and D. Pimental, *Constraints on the Expansion of the Global Food Supply*, *Ambio*, **23**, 198-2005, (1994).
18. D. Pimental et al., *Natural Resources and Optimum Human Population*, *Population and Environment*, **15**, 347-369, (1994).
19. D. Pimental et al., *Environmental and Economic Costs of Soil Erosion and Conservation Benefits*, *Science*, **267**, 1117-1123, (1995).
20. D. Pimental et al., *Natural Resources and Optimum Human Population*, *Population and Environment*, **15**, 347-369, (1994).
21. D. Pimental and M. Pimental, *Food Energy and Society*, University Press of Colorado, Niwot, Colorado, (1996).
22. D. Pimental et al., *Environmental and Economic Costs of Soil Erosion and Conservation Benefits*, *Science*, **267**, 1117-1123, (1995).
23. RS and NAS, *The Royal Society and the National Academy of Sciences on Population Growth and Sustainability*, *Population and Development Review*, **18**, 375-378, (1992).
24. A.M. Altieri, *Agroecology: The Science of Sustainable Agriculture*, Westview Press, Boulder, Colorado, (1995).
25. G. Conway, *The Doubly Green Revolution*, Cornell University Press, (1997).
26. J. Dreze and A. Sen, *Hunger and Public Action*, Oxford University Press, (1991).
27. G. Bridger, and M. de Soissons, *Famine in Retreat?*, Dent, London, (1970).
28. W. Brandt, *World Armament and World Hunger: A Call for Action*, Victor Gollanz Ltd., London, (1982).
29. A.K.M.A. Chowdhury and L.C. Chen, *The Dynamics of Contemporary Famine*, Ford Foundation, Dacca, Pakistan, (1977)
30. J. Shepard, *The Politics of Starvation*, Carnegie Endowment for International Peace, Washington D.C., (1975).
31. M.E. Clark, *Ariadne's Thread: The Search for New Modes of Thinking*, St. Martin's Press, New York, (1989).
32. J.-C. Chesnais, *The Demographic Transition*, Oxford, (1992).
33. C.M. Cipola, *The Economic History of World Population*, Penguin Books Ltd., (1974).
34. E. Draper, *Birth Control in the Modern World*, Penguin Books, Ltd., (1972).
35. Draper Fund Report No. 15, *Towards Smaller Families: The Crucial Role of the Private Sector*, Population Crisis Committee, 1120 Nineteenth Street, N.W., Washington D.C. 20036, (1986).
36. E. Eckholm, *Losing Ground: Environmental Stress and World Food Prospects*, W.W. Norton, New York, (1975).
37. E. Havemann, *Birth Control*, Time-Life Books, (1967).
38. J. Jacobsen, *Promoting Population Stabilization: Incentives for Small Families*, Worldwatch Paper 54, Worldwatch Institute, Washington D.C., (1983).
39. N. Keyfitz, *Applied Mathematical Demography*, Wiley, New York, (1977).

40. W. Latz (ed.), *Future Demographic Trends*, Academic Press, New York, (1979).
41. World Bank, *Poverty and Hunger: Issues and Options for Food Security in Developing Countries*, Washington D.C., (1986).
42. J.E. Cohen, *How Many People Can the Earth Support?*, W.W. Norton, New York, (1995).
43. J. Amos, *Climate Food Crisis to Deepen*, BBC News (5 September, 2005).
44. J. Vidal and T. Ratford, *One in Six Countries Facing Food Shortage*, The Guardian, (30 June, 2005).
45. J. Mann, *Biting the Environment that Feeds Us*, The Washington Post, July 29, 1994.
46. G.R. Lucas, Jr., and T.W. Ogletree, (editors), *Lifeboat Ethics. The Moral Dilemmas of World Hunger*, Harper and Row, New York.
47. J.L. Jacobson, *Gender Bias: Roadblock to Sustainable Development*, Worldwatch Paper 110, Worldwatch Institute, Washington D.C., (1992).
48. J. Gever, R. Kaufmann, D. Skole and C. Vorosmarty, *Beyond Oil: The Threat to Food and Fuel in the Coming Decades*, Ballinger, Cambridge MA, (1986).
49. M. ul Haq, *The Poverty Curtain: Choices for the Third World*, Columbia University Press, New York, (1976).
50. H. Le Bras, *La Planète au Village*, Datar, Paris, (1993).
51. E. Mayr, *Population, Species and Evolution*, Harvard University Press, Cambridge, (1970).
52. Patz, J. A., Campbell-Lendrum, D., Holloway, T. and Foley, J. A. *Impact of regional climate change on human health*. *Nature* **438**, 310-317 (2005).
53. Basu, R. and Samet, J. M. *Relation between elevated ambient temperature and mortality: a review of the epidemiologic evidence*. *Epidemiol. Rev.* **24**, 190-202 (2002).
54. Kovats, R. S. and Hajat, S. *Heat stress and public health: a critical review*. *Annu. Rev. Publ. Health* **29**, 41-55 (2008).
55. Leon, L. R. *Pathophysiology of Heat Stroke* **Vol. 7** (Colloquium Series on Integrated Systems Physiology: From Molecule to Function to Disease, Morgan Claypool Life Sciences, 2015).
56. Ostro, B. D., Roth, L. A., Green, R. S. and Basu, R. *Estimating the mortality effect of the July 2006 California heat wave*. *Environ. Res.* **109**, 614-619 (2009).
57. Glas er, J. et al. *Climate change and the emergent epidemic of CKD from heat stress in rural communities: the case for heat stress nephropathy*. *Clin. J. Am. Soc. Nephrol.* **11**, 1472-1483 (2016).
58. Robine, J.-M. et al. *Death toll exceeded 70,000 in Europe during the summer of 2003*. *C. R. Biol.* **331**, 171-178 (2008).
59. Sillmann, J. and Roeckner, E. *Indices for extreme events in projections of anthropogenic climate change*. *Climatic Change* **86**, 83-104 (2008).
60. Meehl, G. A. and Tebaldi, C. *More intense, more frequent, and longer lasting heat waves in the 21st century*. *Science* **305**, 994-997 (2004).
61. Orłowsky, B. and Seneviratne, S. *Global changes in extreme events: regional and seasonal dimension*. *Climatic Change* **110**, 669-696 (2012).

62. Tebaldi, C., Hayhoe, K., Arblaster, J. M. and Meehl, G. A. *Going to the extremes*. Climatic Change **79**, 185-211 (2006).
63. Tebaldi, C. and Wehner, M. F. *Benefits of mitigation for future heat extremes under RCP4.5 compared to RCP8.5*. Climatic Change <http://dx.doi.org/10.1007/s10584-016-1605-5> (2016).
64. Sterl, A. et al. *When can we expect extremely high surface temperatures?* Geophys. Res. Lett. **35**, L14703 (2008).
65. Huang, C. et al. *Projecting future heat-related mortality under climate change scenarios: a systematic review*. Environ. Health Persp. **119**, 1681-1690 (2011).
66. Guo, Y. et al. *Global variation in the effects of ambient temperature on mortality: a systematic evaluation*. J. Epidemiol. **25**, 781-789 (2014).
67. Luber, G. and McGeehin, M. *Climate change and extreme heat events*. Am. J. Prev. Med. **35**, 429-435 (2008).
68. Bouchama, A. and Knochel, J. P. *Heat stroke*. New. Engl. J. Med. **346**, 1978-1988 (2002).
69. Bobb, J. F., Peng, R. D., Bell, M. L. and Dominici, F. *Heat-related mortality and adaptation to heat in the United States*. Environ. Health Persp. **122**, 811-816 (2014).
70. Gasparrini, A. et al. *Temporal variation in heat-mortality associations: a multi-country study*. Environ. Health Persp. **123**, 1200-1207 (2015).
71. Lowe, D., Ebi, K. L. and Forsberg, B. *Heatwave early warning systems and adaptation advice to reduce human health consequences of heatwaves*. Int. J. Environ. Res. Public Health **8**, 4623-4648 (2011).
72. Hanna, E. G. and Tait, P. W. *Limitations to thermoregulation and acclimatization challenge human adaptation to global warming*. Int. J. Environ. Res. Publ. Health. **12**, 8034-8074 (2015).
73. Sherwood, S. C. and Huber, M. *An adaptability limit to climate change due to heat stress*. Proc. Natl Acad. Sci. USA **107**, 9552-9555 (2010).
74. Whitman, S. et al. *Mortality in Chicago attributed to the July 1995 heat wave*. Am. J. Public Health **87**, 1515-1518 (1997).
75. Dousset, B. et al. *Satellite monitoring of summer heat waves in the Paris metropolitan area*. Int. J. Climatol. **31**, 313-323 (2011).
76. Shaposhnikov, D. et al. *Mortality related to air pollution with the Moscow heat wave and wildfire of 2010*. Epidemiology **25**, 359-364 (2014).
77. Barnett, A. G., Tong, S. and Clements, A. *What measure of temperature is the best predictor of mortality?* Environ. Res. **110**, 604-611 (2010).
78. Willett, K. M. and Sherwood, S. *Exceedance of heat index thresholds for 15 regions under a warming climate using the wet-bulb globe temperature*. Int. J. Climatol. **32**, 161-177 (2012).
79. Argüeso, D., Di Luca, A., Perkins-Kirkpatrick, S. and Evans, J. P. *Seasonal mean temperature changes control future heatwaves*. Geophys. Res. Lett. **43**, 7653-7660 (2016).
80. Jones, B. and O'Neill, B. *Spatially explicit global population scenarios consistent with the Shared Socioeconomic Pathways*. Environ. Res. Lett. **11**, 084003 (2016).

81. Diffenbaugh, N. S. and Field, C. B. *Changes in ecologically critical terrestrial climate conditions*. *Science* **341**, 486-492 (2013).
82. Mitchell, D. et al. *Attributing human mortality during extreme heat waves to anthropogenic climate change*. *Environ. Res. Lett.* **11**, 074006 (2016).

Chapter 6

THE LOSS OF DEMOCRATIC INSTITUTIONS

6.1 Drifting towards neo-fascism

Most notably in the United States and Brazil, but also in a number of other countries, such as Hungary, Turkey and India, there has been a loss of popular control over the institutions of government, and a drift towards authoritarian rule, police brutality, and neo-fascism. Remembering the rise of fascism in Europe in the 1930's we can see worryingly similar trends today.

6.2 Racism, colonialism and exceptionalism

It seems to be possible for nations, and the majority of their citizens, to commit the worst imaginable atrocities, including torture, murder and genocide, while feeling that what they are doing is both noble and good. Some understanding of how this is possible can be gained by watching the 3-part BBC documentary, "The History of Racism".¹

The series was broadcast by BBC Four in March 2007, and videos of the broadcasts are available on the Internet. Watching this eye-opening documentary can give us much insight into the link between racism and colonialism. We can also begin to see how both racism and colonialism are linked to US exceptionalism and neocolonialism.

6.3 Heart of Darkness

Looking at the BBC documentary we can see how often in human history economic greed and colonial exploitation have been justified by racist theories. The documentary describes

¹<https://www.youtube.com/watch?v=efl6T8lovqY>
<https://www.youtube.com/watch?v=IdBDRbjx9jo>
<https://www.youtube.com/watch?v=oCJHJWaNL-g>

almost unbelievable cruelties committed against the peoples of the Americas and Africa by Europeans. For example, in the Congo, a vast region which King Leopold II of Belgium claimed as his private property, the women of villages were held as hostages while the men were forced to gather rubber in the forests. Since neither the men nor the women could produce food under these circumstances, starvation was the result.

Leopold's private army of 90,000 men were issued ammunition, and to make sure that they used it in the proper way, the army was ordered to cut off the hands of their victims and send them back as proof that the bullets had not been wasted. Human hands became a kind of currency, and hands were cut off from men, women and children when rubber quotas were not fulfilled. Sometimes more than a thousand human hands were gathered in a single day. During the rule of Leopold, roughly 10,000,000 Congolese were killed, which was approximately half the population of the region.

According to the racist theories that supported these atrocities, it was the duty of philanthropic Europeans like Leopold to bring civilization and the Christian religion to Africa. Similar theories were used to justify the genocides committed by Europeans against the native inhabitants of the Americas.

Racist theories were also used to justify enormous cruelties committed by the British colonial government in India. For example, during the great famine of 1876-1878, in which ten million people died, the Viceroy, Lord Lytton, oversaw the export to England of a record 6.4 million hundredweight of wheat.

Meanwhile, in Europe, almost everyone was proud of the role which they were playing in the world. All that they read in newspapers and in books or heard from the pulpits of their churches supported the idea that they were serving the non-Europeans by bringing them the benefits of civilization and Christianity. On the whole, the mood of Europe during this orgy of external cruelty and exploitation, was self-congratulatory.

Can we not see a parallel with the self-congratulatory mood of the American people and their allies, who export violence, murder, torture and neocolonialism to the whole world, and who justify it by thinking of themselves as "exceptional"?



Figure 6.1: Half of the population of Belgian Congo died during the rule of Leopold II.

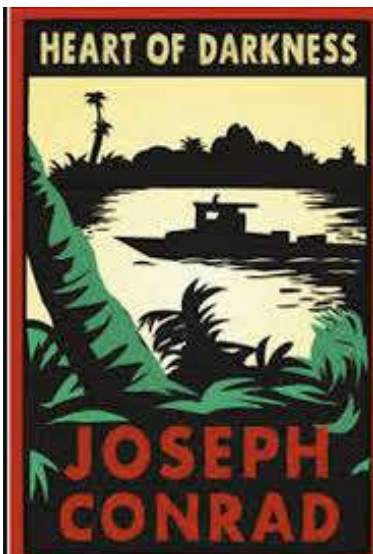

Figure 6.2: Joseph Conrad's famous book was written against the background of Leopold's atrocities.



Figure 6.3: **Heart of Darkness:** In Leopold’s Congo, human hands became a currency.



Figure 6.4: **Heart of Darkness:** Part of a palace built by Leopold II to glorify his “humanitarian” activities in the Congo.

6.4 The racism of Cecil Rhodes

Cecil Rhodes, who was born in Bishop's Stortford in Hertfordshire, came to South Africa in the late 1800s and made his fortune in the country's diamond mines before moving into politics. He served as prime minister of the Cape Colony and later founded the southern African territory of Rhodesia, which would later become independent Zimbabwe. He was the architect of South Africa's notorious apartheid system, and a rabid advocate of British imperialism. Social Darwinism and the eugenics movement may have contributed to the racism and imperialism of Cecil Rhodes.

In a December 2015 article in *The Telegraph*, Dalia Gebrial wrote: "Cecil Rhodes was a man responsible for untold, unending devastation and violence. An architect of South African apartheid, he explicitly believed in the existence of an Anglo-Saxon master race - an ideology that drove him to not only steal approximately one [square] million miles of South African land, but to facilitate the deaths of hundreds of thousands of black South Africans.

"His establishment of a paramilitary private army, the British South Africa Company's Police (BSACP) resulted in the systematic murder of approximately 60,000 people; his amendment of the Masters and Servants Act (1890) reintroduced conditions of torture for black labourers; his infamous racist 'land grabs' set up a system in which the unlawful and illegitimate acquisition of land through armed force was routine.

"In 1887 he told the House of Assembly in Cape Town: 'The native is to be treated as a child and denied the franchise. We must adopt a system of despotism in our relations with the barbarians of South Africa.' His 1892 Franchise and Ballot Act effectively eliminated African voting rights. He repeatedly reminded his colleagues of the 'extreme caution' they must exercise when it comes to 'granting the franchise to coloured people.

Rhodes wanted to create an international movement to extend British influence. He once said: "Why should we not form a secret society with but one object, the furtherance of the British Empire and the bringing of the whole world under British rule, for the recovery of the United States, for making the Anglo-Saxon race but one Empire?"

Rhodes did, in fact, establish this secret society, and it remains very influential today. According to G. Edward Griffin², "Financed by Nathan Rothschild and the Bank of England, he [Rhodes] established a monopoly over the diamond output of South Africa and most of the gold as well. He formed a secret society which included many of the top leaders of British government. Their elitist goal was nothing less than world domination and the establishment of a modern feudal society controlled by themselves through the world's central banks. In America, the Council on Foreign Relations (CFR) was an outgrowth of that group."

²in his book, *The Creature from Jeckyll Island*



Figure 6.5: Nazi genocides: A pile of corpses in the Buchenwald extermination camp.

6.5 Nazi atrocities

During the World War II Holocaust, six million Jews were systematically murdered. This amounted to two thirds of the Jewish population of Europe. A broader definition of the Holocaust includes the murder of the Roma and the “incurably sick”, as well as ethnic Poles, other Slavic groups, Soviet citizens and prisoners of war, homosexuals, Jehovah’s Witnesses, black people, and political opponents.

At least three million Soviet prisoners of war died in German custody, but this figure is small compared with the total number of lives lost in the Soviet Union during World War II. Depending on which historian you believe, the USSR lost at least 11,000,000 soldiers (killed and missing) as well as somewhere between 7,000,000 and 20,000,000 million of its civilians. The total number of people killed in World War II is approximately 60,000,000. If deaths from war-related disease and famine are included, this figure becomes an estimated 80,000,000.

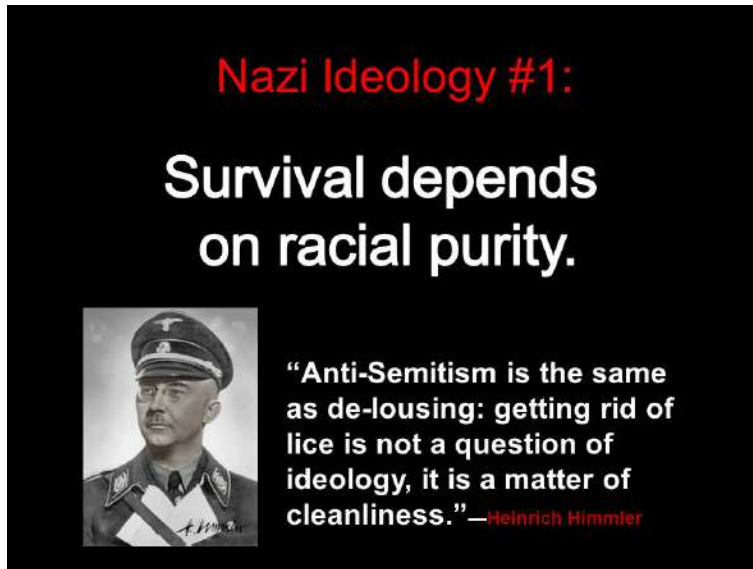

Figure 6.6: The idea of the superiority of one race over another was at the root of Nazi atrocities.



Figure 6.7: Nazi racism was built on the idea that Aryans are superior to all other races. But who is to decide? Will not each ethnic group or nation always decide that they themselves are the “chosen people”, loved by God and superior to all others?



Figure 6.8: **Baba Yar.**



Figure 6.9: **Polish farmers killed by German forces, German-occupied Poland, 1943.**



Figure 6.10: Polish teachers from Bydgoszcz guarded by members of Volksdeutscher Selbstschutz before execution,



Figure 6.11: Mass murder of Soviet civilians near Minsk, 1943.



Figure 6.12: The anti-Jewish pogrom in Kaunas, in which thousands of Jews were killed in the last few days of June 1941.



Figure 6.13: German police shooting women and children from the Mizocz Ghetto, 14 October 1942.

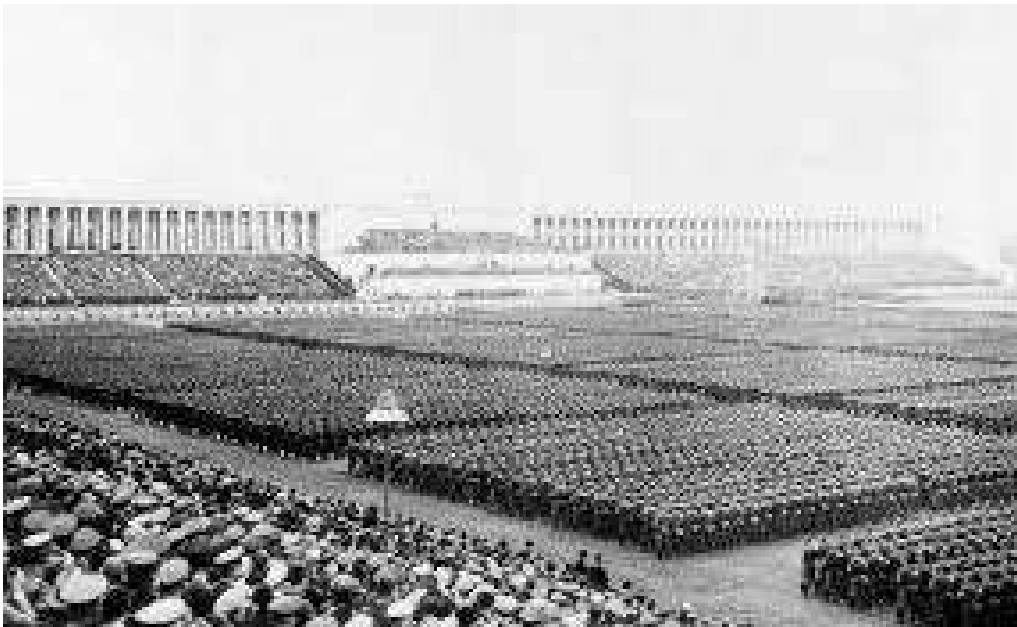

Figure 6.14: Crowds of Germans applauding Adolf Hitler at a rally in Nuremberg.



Figure 6.15: Another photo from Nuremberg. Racism is popular!

6.6 Donald trump was elected on a platform of racism

Here is a list taken from an article by German Lopaz, entitled *Donald Trump's long history of racism, from the 1970s to 2019*³.

- Trump launched his campaign in 2015 by calling Mexican immigrants “rapists” who are “bringing crime” and “bringing drugs” to the US. His campaign was largely built on building a wall to keep these immigrants out of the US.
- As a candidate in 2015, Trump called for a ban on all Muslims coming into the US. His administration eventually implemented a significantly watered-down version of the policy.
- When asked at a 2016 Republican debate whether all 1.6 billion Muslims hate the US, Trump said, “I mean a lot of them. I mean a lot of them.”
- He argued in 2016 that Judge Gonzalo Curiel - who was overseeing the Trump University lawsuit - should recuse himself from the case because of his Mexican heritage and membership in a Latino lawyers association. House Speaker Paul Ryan, who endorsed Trump, later called such comments “the textbook definition of a racist comment.”
- Trump has been repeatedly slow to condemn white supremacists who endorse him, and he regularly retweeted messages from white supremacists and neo-Nazis during his presidential campaign.
- He tweeted and later deleted an image that showed Hillary Clinton in front of a pile of money and by a Jewish Star of David that said, “Most Corrupt Candidate Ever!” The tweet had some very obvious anti-Semitic imagery, but Trump insisted that the star was a sheriff’s badge, and said his campaign shouldn’t have deleted it.
- Trump has repeatedly referred to Sen. Elizabeth Warren (D-MA) as “Pocahontas,” using her controversial - and later walked-back - claims to Native American heritage as a punchline.
- At the 2016 Republican convention, Trump officially seized the mantle of the “law and order” candidate - an obvious dog whistle playing to white fears of black crime, even though crime in the US is historically low. His speeches, comments, and executive actions after he took office have continued this line of messaging.
- In a pitch to black voters in 2016, Trump said, “You’re living in poverty, your schools are no good, you have no jobs, 58 percent of your youth is unemployed. What the hell do you have to lose?”

³<https://www.vox.com/2016/7/25/12270880/donald-trump-racist-racism-history>

- Trump stereotyped a black reporter at a press conference in February 2017. When April Ryan asked him if he plans to meet and work with the Congressional Black Caucus, he repeatedly asked her to set up the meeting - even as she insisted that she's "just a reporter."
- In the week after white supremacist protests in Charlottesville, Virginia, in August 2017, Trump repeatedly said that "many sides" and "both sides" were to blame for the violence and chaos that ensued - suggesting that the white supremacist protesters were morally equivalent to counterprotesters that stood against racism. He also said that there were "some very fine people" among the white supremacists. All of this seemed like a dog whistle to white supremacists - and many of them took it as one, with white nationalist Richard Spencer praising Trump for "defending the truth."
- Throughout 2017, Trump repeatedly attacked NFL players who, by kneeling or otherwise silently protesting during the national anthem, demonstrated against systemic racism in America.
- Trump reportedly said in 2017 that people who came to the US from Haiti "all have AIDS," and he lamented that people who came to the US from Nigeria would never "go back to their huts" once they saw America. The White House denied that Trump ever made these comments.
- Speaking about immigration in a bipartisan meeting in January 2018, Trump reportedly asked, in reference to Haiti and African countries, "Why are we having all these people from shithole countries come here?" He then reportedly suggested that the US should take more people from countries like Norway. The implication: Immigrants from predominantly white countries are good, while immigrants from predominantly black countries are bad.

The disastrous 2016 US election

In the United States, campaigns for the presidential election of 2016 might have been an occasion for a realistic discussion of the enormously important challenges which we now face, not only in the America, but also throughout the world.

Most thoughtful people agree that the two most important issues facing humanity today are the threat of catastrophic and uncontrollable climate change, and the threat of nuclear war. Each of these threatened disasters has the potential to destroy human civilization and much of the biosphere. But on the whole these vitally important issues were not discussed in an honest way in the mainstream media. Instead the campaign spectacle presented to us by the media was washed down into the murky depths of stupidity by rivers of money from the fossil fuel giants and the military industrial complex.

The Republican presidential candidates were almost single-voiced in denying the reality of climate change, and they were almost unanimously behind foreign policy options that would push the world to the brink of nuclear war.

Unless rapid action is taken, the world may soon pass a tipping point after which human efforts to avoid catastrophic climate change will be useless because feedback loops will have taken over. However, our present situation is by no means hopeless, because of the extremely rapid rate of growth of renewable energy. What can governments do to help? They can stop subsidizing the fossil fuel industry! Without massive fossil fuel subsidies, renewables would be the cheaper option, and economic forces alone would drive the urgently-needed transition to 100% renewable energy.

A report by RNE21, a global renewable energy policy network, states that “Global subsidies for fossil fuels remain high despite reform efforts. Estimates range from USD 550 billion (International Energy Agency) to USD 5.6 trillion per year (International Monetary Fund), depending on how ‘subsidy’ is defined and calculated.”

“Growth in renewable energy (and energy efficiency improvements) is tempered by subsidies to fossil fuels and nuclear power, particularly in developing countries. Subsidies keep conventional energy prices artificially low, which makes it more difficult for renewable energy to compete...”

“Creating a level playing field can lead to a more efficient allocation of financial resources, helping to strengthen to advance the development of energy efficiency and renewable energy technologies. Removing fossil fuel and energy subsidies globally would reflect more accurately the true cost of energy generation.”⁴

There is, so to speak, an elephant in the room; but no one wants to talk about it. Everyone (with a very few exceptions) pretends not to see it. They pretend that it is not there. What is this metaphorical elephant? It is the Pentagon’s colossal budget, which is far too sacred a thing to be mentioned in an election campaign.

The size of this budget is almost beyond comprehension: 610 billion dollars per year. This does not include nuclear weapons research, maintenance, cleanup and production, which are paid for by the Department of Energy. Nor does it include payments in pensions to military retirees and widows, nor interest on debt for past wars, nor the State Department’s financing foreign arms sales and military-related development assistance, nor special emergency grants for current wars. Nor are the expenses of the Department of Homeland Security included in the Pentagon’s budget, nor those of the CIA, nor the huge budget of NSA and other dark branches of the US government. One can only guess at the total figure if everything should be included, but it is probably well over a trillion dollars per year.

The hidden presence in the room is a trillion-dollar elephant. Perhaps we should include subsidies to fossil fuel giants. Then we would have a multi-trillion-dollar elephant. But it is too sacred to be mentioned. Cut Medicare! Cut pensions! Cut Social Security! Abolish food stamps! Sacrifice support for education! We are running out of money! (Meanwhile the elephant stands there, too holy to be seen.)

Against expectations, Donald Trump who, in the words of Michael Moore, is a “wretched, ignorant, dangerous part-time clown and full-time sociopath”, was elected in 2016. What happened? Disillusioned by the way in which the immensely popular Senator Bernie

⁴<http://www.ren21.net/status-of-renewables/global-status-report/>



Figure 6.16: Is this the person to whom we ought to entrust the future of our planet? When elected, Donald Trump not only pulled the United States out of the Paris Agreement; he also sabotaged the Environmental Protection Agency to such an extent that the carefully collected facts on climate change that the agency had accumulated had to be secretly saved by scientists to prevent their destruction by the Trump administration. Furthermore, Donald Trump's administration not only subsidizes giant coal corporations. It also has sabotaged renewable energy initiatives in the United States.



Figure 6.17: When Senator Bernie Sanders began his campaign for the Democratic presidential nomination, few people believed that he could succeed. But as his campaign gained momentum, enormous crowds were attracted to his reformist speeches, and small individual donors supported his expenses. Although the crowds at Sanders' speeches were at least four times the size of those attending the rallies of other candidates, they were not reported in the mass media. Sanders' campaign was also sabotaged by the corporate-controlled Democratic National Committee. His huge popularity remains undimmed today, despite his loss in the 2016 primary. He advocates a social system for the United States similar to these which have made the Scandinavian countries leaders in both human development and human happiness indices.



Figure 6.18: Dr. Jill Stein was the Green Party's presidential candidate in 2016. She was the only candidate who was willing to talk about the "elephant in the room" - the obscenely enormous military budget that consumed almost a trillion dollars that could otherwise have been used for social goals, health, education and infrastructure.



Figure 6.19: Disillusioned progressive voters who stayed at home were responsible for Trump's victory. Democrats must be very careful not to make the same mistake in the 2020 election. They must nominate a truly progressive candidate for President. A ticket with Elizabeth Warren for President and Bernie Sanders for Vice-President would certainly beat Trump. A ticket with Joe Biden for President would probably lose. Biden is dangerously similar to Hillary Clinton. He is tainted by corporate money and has blood from the Iraq War on his hands. With Biden as the Democrat's candidate, progressive voters would stay home in disgust in 2020, just as they did in 2016.

Sanders was sabotaged by the media and by the Democratic National Committee, and despising Hillary Clinton for her involvement in US wars and Wall Street banks, many progressive voters stayed away from the polls. In their absence, Trump won narrowly. He lost the popular vote, but won the electoral vote. Today, the White House is a morass of dissension, erratic decisions and lies.

6.7 Children in cages

Inhumane treatment at the border

Here are some excerpts from the written testimony of Clara Long Deputy Washington Director (Acting) Senior Researcher, US Program Human Rights Watch. The testimony was submitted to the U.S. House Committee on Oversight and Reform for a hearing on July 19, 2019.

Our in-depth interviews with children revealed that the US Border Patrol

is holding many children, including some who are much too young to take care of themselves, in jail - like border facilities for weeks at a time without contact with family members, or regular access to showers, clean clothes, toothbrushes, or proper beds. Many were sick. Many, including children as young as 2 or 3, were separated from adult caretakers without any provisions for their care besides that provided by unrelated older children also being held in detention. These conditions are consistent with those Human Rights Watch documented in our February 2018 report, "In the Freezer." In contrast with the conditions as of February 2018, the harms of CBP detention for children are now compounding over weeks instead of days.

On my first day at Clint, I spoke with an 11-year-old boy who was caring for his 3-year-old brother. Both were fending for themselves in cinder-block cells with dozens of other children for three weeks. When I met them, the little one was quiet with matted hair, a hacking cough, muddy pants and eyes that fluttered closed with fatigue. As we spoke, he fell asleep on two office chairs drawn together. "I am the one who takes care of him here," the older brother told us. "There was a teenage girl with curly hair who was helping me take care of him for a while. I don't know her name. But she's gone now. Now, no one helps me to take care of him."

A 14-year-old told our team she was taking care of a 4-year-old girl who had been placed in her cell with no relatives. "I take her to the bathroom, give her my extra food if she is hungry, and tell people to leave her alone if they are bothering her", she said. "She has been sick the whole time I have been taking care of her, and is coughing and has mucous. She doesn't talk hardly at all, just 'yes' and 'no'. She wears diapers and I change them for her..."

We also spoke with children who had been held for some period of time in quarantine cells. A 14-year-old girl told us, "I was in the first cell for seven days, sleeping with no mattress. It is hard to sleep when you don't have a mattress. I then came down with the flu. I then went into the flu cell for seven days. When you are in the flu cell, you also sleep on the floor, but you have a mattress. There were 21 other kids in that space with the flu. I had a fever in there and I was shaking. Some of the other kids were vomiting. They all had fevers. No one was taking care of the kids with the flu... We were not allowed to leave the flu cell, ever. It was very boring. I did nothing to entertain myself, nor was anything offered. It was sad, very sad. I felt locked up and closed in."

An 11-year-old boy held in CBP custody for 12 days, despite having parents in New Jersey, said, "About three days ago I got a fever. They moved me alone to a flu cell. There is no one to take care of you there. They just give you pills twice a day. I also am having an allergic reaction all over my skin. My skin is itchy and red and my nose is stuffed up. Two times they gave me a pill for it but not anymore"

A 7-year-old girl I attempted to interview entered the room silently but burst into tears when we asked whom she traveled with to the US. "My aunt,"



she said, with a keening cry. She was so upset we decided not to attempt to interview her, a situation that happened several times during our visit. A bracelet on her wrist had the words “US parent” and a phone number written in permanent marker. We called the number on the spot and found out that no one had informed her desperate parents where she was being held. Some of the most emotional moments of our visit came witnessing children speak for the first time with their parents on an attorney’s phone.

Based on our interviews, US officials at the border seem to be making no discernible effort to release children to caregivers while children are in Customs and Border Protection custody - though many have parents in the US - rather than holding them for weeks in overcrowded cells, incommunicado from their desperate loved ones.

The definition of genocide

Here is the UN’s definition of genocide under the statutes of the International Criminal Court:

“In the present Convention, genocide means any of the following acts committed with intent to destroy, in whole or in part, a national, ethnical, racial or religious group, as such:

- a Killing members of the group;
- b Causing serious bodily or mental harm to members of the group;
- c Deliberately inflicting on the group conditions of life calculated to bring about its physical destruction in whole or in part;
- d Imposing measures intended to prevent births within the group;







(e) **Forcibly transferring children of the group to another group.”**

Does not the treatment of children at the US southern border fulfill this definition?

6.8 Demonizing the Squad

On Sunday, July 14, Trump Tweeted

“So interesting to see ‘Progressive’ Democrat Congresswomen, who originally came from countries whose governments are a complete and total catastrophe, the worst, most corrupt and inept anywhere in the world (if they even have a functioning government at all), now loudly and viciously telling the people of the United States, the greatest and most powerful Nation on earth, how our government is to be run,”

“Why don’t they go back and help fix the totally broken and crime infested places from which they came. Then come back and show us how it is done. These places need your help badly, you can’t leave fast enough. I’m sure that Nancy Pelosi would be very happy to quickly work out free travel arrangements!”

His targets were the four first-term congresswomen known as the Squad: Representatives Alexandria Ocasio-Cortez (D-NY), Ayanna Pressley (D-MA), Rashida Tlaib (D-MI), and Ilhan Omar (D-MN). Of the four, only Omar was born outside the United States. Trump later accused the four women of hating America and not loving Israel enough. This is one more example of Trump’s racist rhetoric.

The United States is a multiethnic country, whose internal cohesion can easily be destroyed by racism. During most of its history, the US has had substantial Spanish-speaking and Italian-speaking minorities, as well as great religious diversity. During the 1960’s the civil rights movement fought against racial prejudice and gradually achieved most



Figure 6.20: The “Squad”, four first-term congresswomen: Representatives Alexandria Ocasio-Cortez (D-NY), Ayanna Pressley (D-MA), Rashida Tlaib (D-MI), Alexandria Ocasio-Cortez (lower left) has made extremely important contributions to the struggle to avoid catastrophic climate change. Highly intelligent, vocal, eloquent and witty, she is a thorn in the Republican’s side.

of its goals. Thus, over a very long period of time, the United States learned to avoid racial and religious insults in its media, and this hard-earned wisdom has allowed the very markedly multi-ethnic US society to function with a minimum of racial and religious conflicts. Trump's racism risks destroying these hard-earned lessons.

6.9 Jair Bolsonaro, the Trump of the Tropics

The newly elected President of Brazil, Jair Bolsonaro, has praised Pinochet, expressed support for torturers and called for political opponents to be shot, earning him the label of "the most misogynistic, hateful elected official in the democratic world". Bolsonaro speaks nostalgically about the country's 1964-1985 military dictatorship and has promised to fill his government with current and former military leaders. Here, in his own words, are some of his ideas:

On refugees: "The scum of the earth is showing up in Brazil, as if we didn't have enough problems of our own to sort out." (September 2015)

On gay people: "I would be incapable of loving a homosexual son. I'm not going to be a hypocrite: I'd rather my son died in an accident than showed up with some bloke with a moustache." (June 2011)

On democracy and dictatorship: "You'll never change anything in this country through voting. Nothing. Absolutely nothing. Unfortunately, things will only change when a civil war kicks off and we do the work the [military] regime didn't. Killing some 30,000... Killing them! If a couple of innocents die, that's OK." (May 1999)

On human rights: "I'm in favour of torture." (May 1999)

On women: "I said I wouldn't rape you because you don't deserve it." (December 2014, to politician Maria do Rosário, repeating a comment first made to her in 2003).

Indigenous rights activists fear Bolsonaro's avowed plan to wring riches from the Amazon - whether from expanding agriculture into indigenous lands, building roads and other infrastructure projects, or allowing mining on public lands - will unleash a tide of violence and environmental devastation.

"All indigenous communities are afraid right now," says Felipe Milanez, professor of humanities at the Universidade Federal de Bahia. "There is a risk of brutal, violent attack." Milanez fears that indigenous efforts to patrol and protect their own lands from outsiders, such as the Forest Guardians recently covered in National Geographic magazine, will be banned and persecuted.

"His economic project is to destroy the Amazon, to transform the Amazon into commodities for export," Milanez says.



Figure 6.21: Jair Bolsonaro visiting Donald Trump in Washington. Like Trump, he is an utterly despicable person, but (again like Trump) his worst crime is against the future of human civilization and the biosphere. Under Bolsonaro, the vitally important Amazon rainforests are being destroyed, a terrible blow to our efforts to avoid catastrophic ciliate change.



Figure 6.22: The indigenous peoples of the Amazon are the guardians of the lungs of Planet Earth. Within hours of taking office on 1 January, 2019, the Trump of the Tropics, aka the new President of Brazil, Jair Bolsonaro, launched an all-out assault against the Amazon rainforest and its indigenous communities, potentially paving the way for large scale deforestation by agricultural, mining and oil companies.

Human rights activists are concerned that a surge in violent land conflicts will accompany an increase in environmentally destructive development in the Amazon. “There is no doubt that devastation will spread in the region,” says Diogo Cabral, an attorney with the Sociedade Maranhense de Direitos Humanos. “At the same time, he aims to extinguish policies that protect human rights defenders in Brazil. Under Bolsonaro, human life will have no value.”

The indigenous peoples’ website Mongabay ⁵ states that “The potentially resulting wholesale deforestation could be a disaster to indigenous peoples, biodiversity, and even the regional and global climate.”

It adds: “Bolsonaro’s proposed Amazon policies, if carried out, could ultimately help dash the world’s hopes of achieving the global climate goals agreed to in Paris, a failure that could lead to climate chaos.”

Leading Brazilian researchers, from the National Institute of Space Research (INPE), have calculated that Bolsonaro’s policies could triple deforestation in the Amazon from present levels of 6,900 square kilometers (2,664 square miles) annually, to 25,600 square kilometers (9,884 square miles) per year by 2020.

6.10 Revival of Nazi ideology after World War II

According to Wikipedia, “Neo-Nazism consists of post-World War II militant social or political movements seeking to revive and implement the ideology of Nazism. Neo-Nazis seek to employ their ideology to promote hatred and attack minorities, or in some cases to create a fascist political state. It is a global phenomenon, with organized representation in many countries and international networks. It borrows elements from Nazi doctrine, including ultranationalism, racism, xenophobia, ableism, homophobia, anti-Romanyism, antisemitism, anti-communism and initiating the Fourth Reich. Holocaust denial is a common feature, as is the incorporation of Nazi symbols and admiration of Adolf Hitler.

“In some European and Latin American countries, laws prohibit the expression of pro-Nazi, racist, anti-Semitic, or homophobic views. Many Nazi-related symbols are banned in many European countries - in particular Germany and Austria - in an effort to curtail neo-Nazism.

“Following the defeat of Nazi Germany, the political ideology of the ruling party, Nazism, was in complete disarray. However, conspiracy theories emerged about Hitler himself, that he had secretly survived the war and fled to South America or elsewhere.

“The Allied Control Council officially dissolved the NSDAP on 10 October 1945, marking the end of ”Old” National Socialism. A process of denazification began, and the Nuremberg trials took place, where many major leaders and ideologues were condemned to death by October 1946, others committed suicide. Otto Ernst Remer, leader of the postwar Socialist Reich Party.

⁵<https://news.mongabay.com/2019/01/bolsonaro-hands-over-indigenous-land-demarcation-to-agriculture-ministry/?fbclid=IwAR3UG-jneDheuddVEWVcCrcWkK4bnnsdE1uIBMLlnLtS6zGqMmGSPxtgEzM>

“In both the East and West, surviving ex-party members and military veterans assimilated to the new reality and had no interest in constructing a ”neo-Nazism.” However, during the 1949 elections a number of National Socialist advocates such as Fritz Rössler had infiltrated the national conservative Deutsche Rechtspartei, which had 5 members elected. Rössler and others left to found the more radical Socialist Reich Party under Otto Ernst Remer. At the onset of the Cold War, the SRP favoured the Soviet Union over the United States.”



Figure 6.23: Otto Ernst Remer, leader of the postwar Socialist Reich Party.



Figure 6.24: Otto Strasser, leader of the German Social Union, returned from exile to Germany in the mid-1950s.



Figure 6.25: **George Lincoln Rockwell**, founder of the American Nazi Party and progenitor of subsequent uniformed neo-Nazi groups.



Figure 6.26: The Italian group Ordine Nuovo, banned in 1974, drew influence from the Waffen-SS and Guénonian Traditionalism via Julius Evola.



Figure 6.27: The radicalisation of Flemish activist group the Vlaamse Militanten Orde in the 1970s, energized international neo-Nazism.

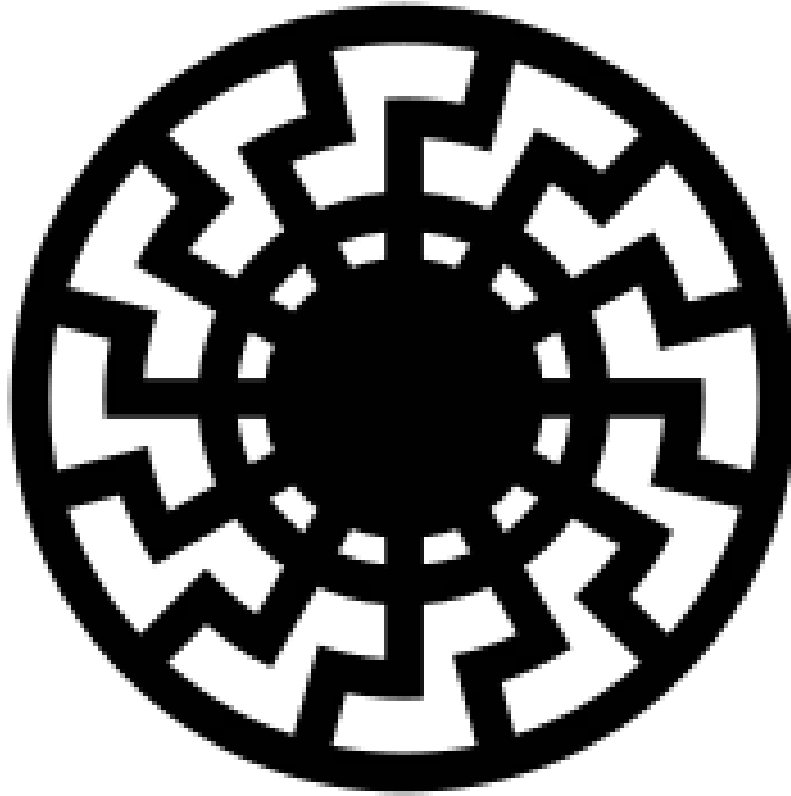

Figure 6.28: Serrano identified Aryan-Hyperborean blood as the “light of the Black Sun”, a symbol found at SS-cult site Wewelsburg Castle.



Figure 6.29: Members of the National Bolshevik Party. “Nazbols” tailor ultra-nationalist themes to a native Russian environment while still employing National Socialist aesthetics.



Figure 6.30: The nearest Italy came to returning to fascism was the 1970 Golpe Borghese of commando veteran Junio Valerio Borghese.

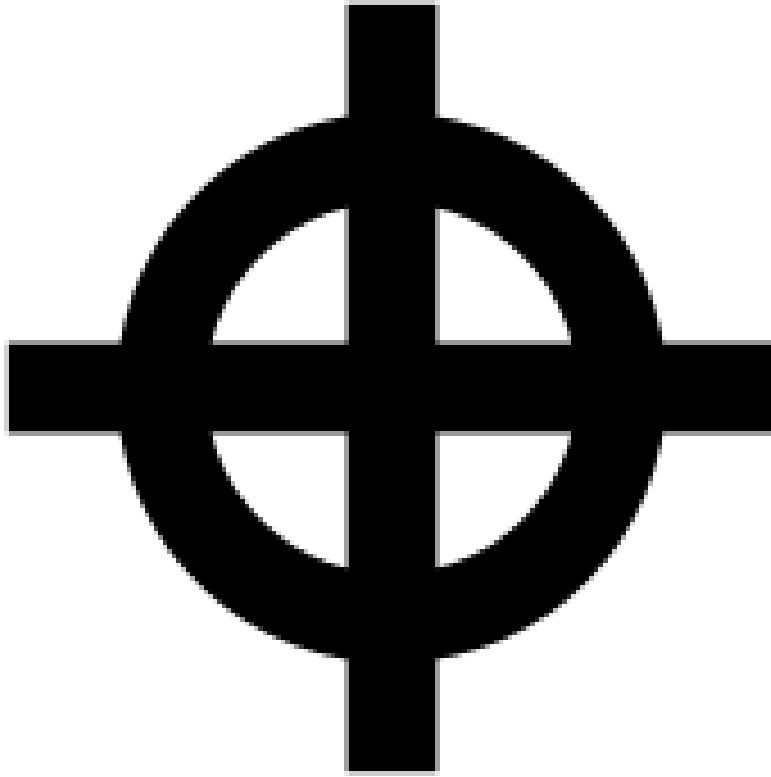

Figure 6.31: French neo-fascist groups adopted the Celtic cross as an ambiguous “Christian and pagan” symbol since the 1940s.



Figure 6.32: Young boy wearing a shirt with a Black Legion sign at a Thompson concert in Croatia.



Figure 6.33: “Hungaria Skins” with a flag evoking the Arrow Cross in 1997.



Figure 6.34: Protesters with neo-Nazi symbols - SS-Volunteer Division “Galicia” and Patriot of Ukraine flags.



Figure 6.35: Ukrainian volunteer battalion members with neo-Nazi Wolfsangel symbol, 24 July 2014.



Figure 6.36: Neo-Nazi skinheads in Spain.



Figure 6.37: Neo-Nazi demonstration in Leipzig, Germany in October 2009.

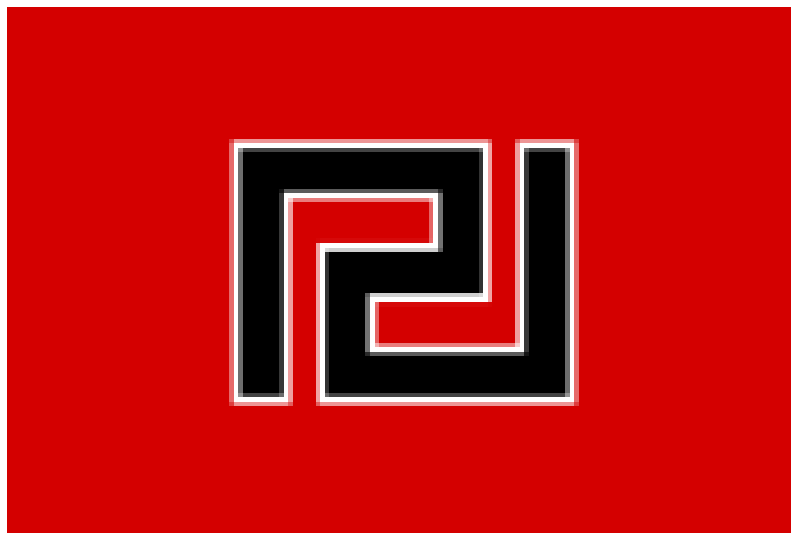

Figure 6.38: Flag of the Golden Dawn (Greece).



Figure 6.39: ONR march in Poznań in November 2015.



Figure 6.40: Neo-Nazism in Russia: The photograph was taken at an anti-gay demonstration in Moscow in October 2010.

6.11 Trump copies Hitler's rhetoric

Book review: *When at Times the Mob Is Swayed*

Below are some quotations from an article by Steven Rosenfeld, published by *Common Dreams* on Friday, August 9, 2019. Rosenfeld's article is a review of a book by Bert Neuborne entitled *When at Times the Mob Is Swayed: A Citizen's Guide to Defending Our Republic*.

Neuborne doesn't make this comparison [between Trump and Hitler] lightly. His 55-year career began by challenging the constitutionality of the Vietnam War in the 1960s. He became the ACLU's national legal director in the 1980s under Ronald Reagan. He was founding legal director of the Brennan Center for Justice at New York University Law School in the 1990s. He has been part of more than 200 Supreme Court cases and Holocaust reparation litigation.

"Why does an ignorant, narcissistic buffoon like Trump trigger such anxiety? Why do so many Americans feel it existentially (not just politically) important to resist our forty-fifth president?" he writes. "Partly it's just aesthetics. Trump is such a coarse and appalling man that it's hard to stomach his presence in Abraham Lincoln's house. But that's not enough to explain the intensity of my dread. LBJ was coarse. Gerald Ford and George W. Bush were dumb as rocks. Richard Nixon was an anti-Semite. Bill Clinton's mistreatment of women dishonored his office. Ronald Reagan was a dangerous ideologue. I opposed each of them when they appeared to exceed their constitutional powers. But I never felt a sense of existential dread. I never sensed that the very existence of a tolerant democracy was in play."

A younger Trump, according to his first wife's divorce filings, kept and studied a book translating and annotating Adolf Hitler's pre-World War II speeches in a locked bedside cabinet, Neuborne noted. The English edition of *My New Order*, published in 1941, also had analyses of the speeches' impact on his era's press and politics. "Ugly and appalling as they are, those speeches are masterpieces of demagogic manipulation," Neuborne says.

"Watching Trump work his crowds, though, I see a dangerously manipulative narcissist unleashing the demagogic spells that he learned from studying Hitler's speeches - spells that he cannot control and that are capable of eroding the fabric of American democracy," Neuborne says. "You see, we've seen what these rhetorical techniques can do. Much of Trump's rhetoric - as a candidate and in office - mirrors the strategies, even the language, used by Adolf Hitler in the early 1930s to erode German democracy."

Many Americans may seize or condemn Neuborne's analysis, which has more than 20 major points of comparison. The author repeatedly says his goal is not "equating" the men - as "it trivializes Hitler's obscene crimes to compare them to Trump's often pathetic foibles."

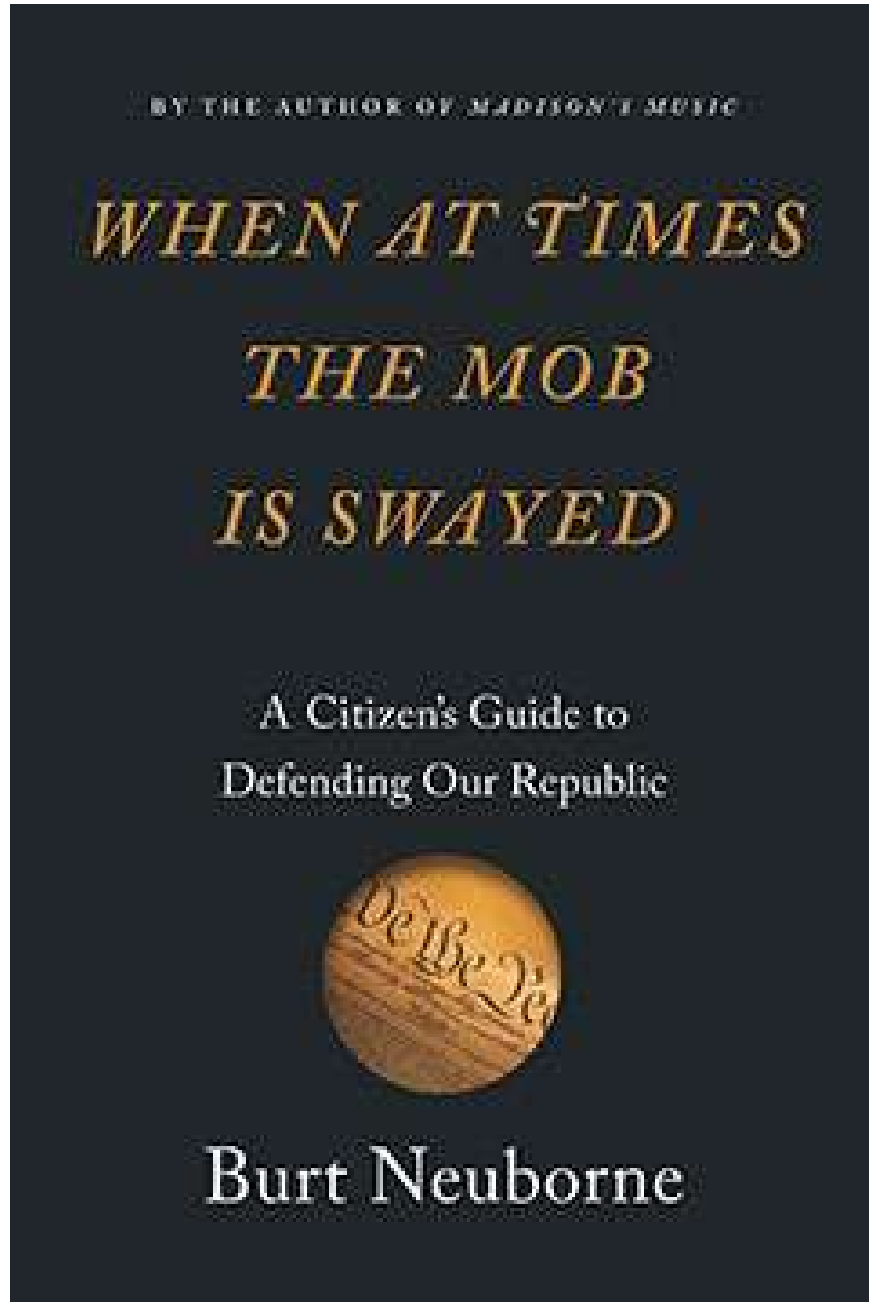

Figure 6.41: Burt Neuborne's brilliant book on the current crisis of American democracy is a warning that we must take very seriously.



Indeed, the book has a larger frame: whether federal checks and balances - Congress, the Supreme Court, the Electoral College - can contain the havoc that Trump thrives on and the Republican Party at large has embraced. But the Trump-Hitler compilation is a stunning warning, because, as many Holocaust survivors have said, few Germans or Europeans expected what unfolded in the years after Hitler amassed power.

Here's how Neuborne introduces this section. Many recent presidents have been awful, "But then there was Donald Trump, the only president in recent American history to openly despise the twin ideals - individual dignity and fundamental equality - upon which the contemporary United States is built. When you confront the reality of a president like Trump, the state of both sets of brakes - internal [constitutional] and external [public resistance] - become hugely important because Donald Trump's political train runs on the most potent and dangerous fuel of all: a steady diet of fear, greed, loathing, lies, and envy. It's a toxic mixture that has destroyed democracies before, and can do so again.

"Give Trump credit," he continues. "He did his homework well and became the twenty-first-century master of divisive rhetoric. We're used to thinking of Hitler's Third Reich as the incomparably evil tyranny that it undoubtedly was. But Hitler didn't take power by force. He used a set of rhetorical tropes codified in Trump's bedside reading that persuaded enough Germans to welcome Hitler as a populist leader. The Nazis did not overthrow the Weimar Republic. It fell into their hands as the fruit of Hitler's satanic ability to mesmerize enough Germans to trade their birthright for a pottage of scapegoating, short-term economic gain, xenophobia, and racism. It could happen here."

Twenty points of similarity

Neuborne lists the following points of similarity between early Hitler and Trump:

1. Neither was elected by a majority. Trump lost the popular vote by 2.9 million votes, receiving votes by 25.3 percent of all eligible American voters. "That's just a little less than the percentage of the German electorate that turned to the Nazi Party in 1932-33," Neuborne writes. "Unlike the low turnouts in the United States, turnout in Weimar Germany averaged just over 80 percent of eligible voters." He continues, "Once installed as a minority chancellor in January 1933, Hitler set about demonizing his political opponents, and no one - not the vaunted, intellectually brilliant German judiciary; not the respected, well-trained German police; not the revered, aristocratic German military; not the widely admired, efficient German government bureaucracy; not the wealthy, immensely powerful leaders of German industry; and not the powerful center-right political leaders of the Reichstag - mounted a serious effort to stop him."

2. Both found direct communication channels to their base. By 1936's Olympics, Nazi narratives dominated German cultural and political life. "How on earth did Hitler pull it off? What satanic magic did Trump find in Hitler's speeches?" Neuborne asks. He addresses Hitler's extreme rhetoric soon enough, but notes that Hitler found a direct communication pathway - the Nazi Party gave out radios with only one channel, tuned to Hitler's voice, bypassing Germany's news media. Trump has an online equivalent.

"Donald Trump's tweets, often delivered between midnight and dawn, are the twenty-first century's technological embodiment of Hitler's free plastic radios," Neuborne says. "Trump's Twitter account, like Hitler's radios, enables a charismatic leader to establish and maintain a personal, unfiltered line of communication with an adoring political base of about 30-40 percent of the population, many (but not all) of whom are only too willing, even anxious, to swallow Trump's witches' brew of falsehoods, half-truths, personal invective, threats, xenophobia, national security scares, religious bigotry, white racism, exploitation of economic insecurity, and a never ending-search for scapegoats."

3. Both blame others and divide on racial lines. As Neuborne notes, "Hitler used his single-frequency radios to wax hysterical to his adoring base about his pathological racial and religious fantasies glorifying Aryans and demonizing Jews, blaming Jews (among other racial and religious scapegoats) for German society's ills." That is comparable to "Trump's tweets and public statements, whether dealing with black-led demonstrations against police violence, white-led racist mob violence, threats posed by undocumented aliens, immigration policy generally, protests by black and white professional athletes, college admission policies, hate speech, even response to hurricane damage in Puerto Rico," he says. Again and again, Trump uses "racially tinged messages calculated to divide whites from people of color."
4. Both relentlessly demonize opponents. "Hitler's radio harangues demonized his domestic political opponents, calling them parasites, criminals, cockroaches, and various categories of leftist scum," Neuborne notes. "Trump's tweets and speeches similarly demonize his political opponents. Trump talks about the country being 'infested' with dangerous aliens of color. He fantasizes about jailing Hillary Clinton, calls Mexicans rapists, refers to 'shithole countries,' degrades anyone who disagrees with him, and dreams of uprooting thousands of allegedly disloyal bureaucrats in the State Department, the Environmental Protection Agency, the FBI, and the CIA, who he calls 'the deep state' and who, he claims, are sabotaging American greatness."

5. They unceasingly attack objective truth. “Both Trump and Hitler maintained a relentless assault on the very idea of objective truth,” he continues. “Each began the assault by seeking to delegitimize the mainstream press. Hitler quickly coined the epithet *Lügenpresse* (literally ‘lying press’) to denigrate the mainstream press. Trump uses a paraphrase of Hitler’s lying press epithet - ‘fake news’ - cribbed, no doubt, from one of Hitler’s speeches. For Trump, the mainstream press is a ‘lying press’ that publishes ‘fake news.’” Hitler attacked his opponents as spreading false information to undermine his positions, Neuborne says, just as Trump has attacked “elites” for disseminating false news, “especially his possible links to the Kremlin.”
6. They relentlessly attack mainstream media. Trump’s assaults on the media echo Hitler’s, Neuborne says, noting that he “repeatedly attacks the ‘failing New York Times,’ leads crowds in chanting ‘CNN sucks,’ [and] is personally hostile to most reporters.” He cites the White House’s refusal to fly the flag at half-mast after the murder of five journalists in Annapolis in June 2018, Trump’s efforts to punish CNN by blocking a merger of its corporate parent, and trying to revoke federal Postal Service contracts held by Amazon, which was founded by Jeff Bezos, who also owns the Washington Post.
7. Their attacks on truth include science. Neuborne notes, “Both Trump and Hitler intensified their assault on objective truth by deriding scientific experts, especially academics who question Hitler’s views on race or Trump’s views on climate change, immigration, or economics. For both Trump and Hitler, the goal is (and was) to eviscerate the very idea of objective truth, turning everything into grist for a populist jury subject to manipulation by a master puppeteer. In both Trump’s and Hitler’s worlds, public opinion ultimately defines what is true and what is false.”
8. Their lies blur reality - and supporters spread them. “Trump’s pathological penchant for repeatedly lying about his behavior can only succeed in a world where his supporters feel free to embrace Trump’s ‘alternative facts’ and treat his hyperbolic exaggerations as the gospel truth,” Neuborne says. “Once Hitler had delegitimized the mainstream media by a series of systematic attacks on its integrity, he constructed a fawning alternative mass media designed to reinforce his direct radio messages and enhance his personal power. Trump is following the same path, simultaneously launching bitter attacks on the mainstream press while embracing the so-called alt-right media, co-opting both Sinclair Broadcasting and the Rupert Murdoch-owned Fox Broadcasting Company as, essentially, a Trump Broadcasting Network.”

9. Both orchestrated mass rallies to show status. “Once Hitler had cemented his personal communications link with his base via free radios and a fawning media and had badly eroded the idea of objective truth, he reinforced his emotional bond with his base by holding a series of carefully orchestrated mass meetings dedicated to cementing his status as a charismatic leader, or Führer,” Neuborne writes. “The powerful personal bonds nurtured by Trump’s tweets and Fox’s fawning are also systematically reinforced by periodic, carefully orchestrated mass rallies (even going so far as to co-opt a Boy Scout Jamboree in 2017), reinforcing Trump’s insatiable narcissism and his status as a charismatic leader.”
10. They embrace extreme nationalism. “Hitler’s strident appeals to the base invoked an extreme version of German nationalism, extolling a brilliant German past and promising to restore Germany to its rightful place as a preeminent nation,” Neuborne says. “Trump echoes Hitler’s jingoistic appeal to ultranationalist fervor, extolling American exceptionalism right down to the slogan ‘Make America Great Again,’ a paraphrase of Hitler’s promise to restore German greatness.”
11. Both made closing borders a centerpiece. “Hitler all but closed Germany’s borders, freezing non-Aryan migration into the country and rendering it impossible for Germans to escape without official permission. Like Hitler, Trump has also made closed borders a centerpiece of his administration,” Neuborne continues. “Hitler barred Jews. Trump bars Muslims and seekers of sanctuary from Central America. When the lower courts blocked Trump’s Muslim travel ban, he unilaterally issued executive orders replacing it with a thinly disguised substitute that ultimately narrowly won Supreme Court approval under a theory of extreme deference to the president.”
12. They embraced mass detention and deportations. “Hitler promised to make Germany free from Jews and Slavs. Trump promises to slow, stop, and even reverse the flow of non-white immigrants, substituting Muslims, Africans, Mexicans, and Central Americans of color for Jews and Slavs as scapegoats for the nation’s ills. Trump’s efforts to cast dragnets to arrest undocumented aliens where they work, live, and worship, followed by mass deportation... echo Hitler’s promise to defend Germany’s racial identity,” he writes, also noting that Trump has “stooped to tearing children from their parents [as Nazis in World War II would do] to punish desperate efforts by migrants to find a better life.”
13. Both used borders to protect selected industries. “Like Hitler, Trump seeks to use national borders to protect his favored national interests, threatening to ignite protectionist trade wars with Europe, China, and

Japan similar to the trade wars that, in earlier incarnations, helped to ignite World War I and World War II,” Neuborne writes. “Like Hitler, Trump aggressively uses our nation’s political and economic power to favor selected American corporate interests at the expense of foreign competitors and the environment, even at the price of international conflict, massive inefficiency, and irreversible pollution [climate change].”

14. They cemented their rule by enriching elites. “Hitler’s version of fascism shifted immense power - both political and financial - to the leaders of German industry. In fact, Hitler governed Germany largely through corporate executives,” he continues. “Trump has also presided over a massive empowerment - and enrichment - of corporate America. Under Trump, large corporations exercise immense political power while receiving huge economic windfalls and freedom from regulations designed to protect consumers and the labor force. Hitler despised the German labor movement, eventually destroying it and imprisoning its leaders. Trump also detests strong unions, seeking to undermine any effort to interfere with the ’prerogatives of management.”
15. Both rejected international norms. “Hitler’s foreign policy rejected international cooperation in favor of military and economic coercion, culminating in the annexation of the Sudetenland, the phony Hitler-Stalin nonaggression pact, the invasion of Czechoslovakia, and the horrors of global war,” Neuborne notes. “Like Hitler, Trump is deeply hostile to multinational cooperation, withdrawing from the Trans-Pacific Partnership, the Paris Agreement on climate change, and the nuclear agreement with Iran, threatening to withdraw from the North American Free Trade Agreement, abandoning our Kurdish allies in Syria...”
16. They attack domestic democratic processes. “Hitler attacked the legitimacy of democracy itself, purging the voting rolls, challenging the integrity of the electoral process, and questioning the ability of democratic government to solve Germany’s problems,” Neuborne notes. “Trump has also attacked the democratic process, declining to agree to be bound by the outcome of the 2016 elections when he thought he might lose, supporting the massive purge of the voting rolls allegedly designed to avoid (nonexistent) fraud, championing measures that make it harder to vote, tolerating - if not fomenting - massive Russian interference in the 2016 presidential election, encouraging mob violence at rallies, darkly hinting at violence if Democrats hold power, and constantly casting doubt on the legitimacy of elections unless he wins.”
17. Both attack the judiciary and rule of law. “Hitler politicized and eventually destroyed the vaunted German justice system. Trump also seeks to

turn the American justice system into his personal playground,” Neuborne writes. “Like Hitler, Trump threatens the judicially enforced rule of law, bitterly attacking American judges who rule against him, slyly praising Andrew Jackson for defying the Supreme Court, and abusing the pardon power by pardoning an Arizona sheriff found guilty of criminal contempt of court for disobeying federal court orders to cease violating the Constitution.”

18. Both glorify the military and demand loyalty oaths. “Like Hitler, Trump glorifies the military, staffing his administration with layers of retired generals (who eventually were fired or resigned), relaxing control over the use of lethal force by the military and the police, and demanding a massive increase in military spending,” Neuborne writes. Just as Hitler “imposed an oath of personal loyalty on all German judges” and demanded courts defer to him, “Trump’s already gotten enough deference from five Republican [Supreme Court] justices to uphold a largely Muslim travel ban that is the epitome of racial and religious bigotry.” Trump has also demanded loyalty oaths. “He fired James Comey, a Republican appointed in 2013 as FBI director by President Obama, for refusing to swear an oath of personal loyalty to the president; excoriated and then sacked Jeff Sessions, his handpicked attorney general, for failing to suppress the criminal investigation into... Trump’s possible collusion with Russia in influencing the 2016 elections; repeatedly threatened to dismiss Robert Mueller, the special counsel carrying out the investigation; and called again and again for the jailing of Hillary Clinton, his 2016 opponent, leading crowds in chants of ‘lock her up.’” A new chant, “send her back,” has since emerged at Trump rallies directed at non-white Democratic congresswomen.
19. They proclaim unchecked power. “Like Hitler, Trump has intensified a disturbing trend that predated his administration of governing unilaterally, largely through executive orders or proclamations,” Neuborne says, citing the Muslim travel ban, trade tariffs, unraveling of health and environmental safety nets, ban on transgender military service, and efforts to end President Obama’s protection for Dreamers. “Like Hitler, Trump claims the power to overrule Congress and govern all by himself. In 1933, Hitler used the pretext of the Reichstag fire to declare a national emergency and seize the power to govern unilaterally. The German judiciary did nothing to stop him. German democracy never recovered. When Congress refused to give Trump funds for his border wall even after he threw a tantrum and shut down the government, Trump, like Hitler, declared a phony national emergency and claimed the power to ignore Congress,” Neuborne continues. “Don’t count on the Supreme Court to stop him. Five justices gave the game away on the President’s unilateral travel ban.

They just might do the same thing on the border wall.” It did in late July, ruling that Trump could divert congressionally appropriated funds from the Pentagon budget - undermining constitutional separation of powers.

20. Both relegate women to subordinate roles. “Finally,” writes Neuborne, “Hitler propounded a misogynistic, stereotypical view of women, valuing them exclusively as wives and mothers while excluding them from full participation in German political and economic life. Trump may be the most openly misogynist figure ever to hold high public office in the United States, crassly treating women as sexual objects, using nondisclosure agreements and violating campaign finance laws to shield his sexual misbehavior from public knowledge, attacking women who come forward to accuse men of abusive behavior, undermining reproductive freedom, and opposing efforts by women to achieve economic equality.”

Suggestions for further reading

1. Graham, David A.; Green, Adrienne; Murphy, Cullen; Richards, Parker. *An Oral History of Trump's Bigotry*. The Atlantic, (June 2019).
2. Allen, Theodore. *The Invention of the White Race: Volume 1* London: Verso, (1994).
3. Barkan, Elazar. *The Retreat of Scientific Racism : Changing Concepts of Race in Britain and the United States between the World Wars*, Cambridge University Press, New York, (1992).
4. Bonilla-Silva, Eduardo. *Racism without Racists: Color-Blind Racism and the Persistence of Racial Inequality in the United States*. Rowman & Littlefield Publishers, Inc, (2018).
5. Curta, Florin. *The Making of the Slavs: History and Archaeology of the Lower Danube Region, c. 500-700*. Cambridge: Cambridge University Press, (2001).
6. Dain, Bruce. *A Hideous Monster of the Mind : American Race Theory in the Early Republic*, Harvard University Press, Cambridge, (2002).
7. Daniels, Jessie. *White Lies: Race, Class, Gender and Sexuality in White Supremacist Discourse*, Routledge, New York, (1997).
8. Daniels, Jessie. *Cyber Racism: White Supremacy Online and the New Attack on Civil Rights*, Rowman & Littlefield, Lanham, MD. (2009).
9. Ehrenreich, Eric. *The Nazi Ancestral Proof: Genealogy, Racial Science, and the Final Solution*, Indiana University Press, Bloomington, (2007).
10. Martin A. Lee, *The Beast Reawakens*, (New York: Little, Brown and Company, (1997)
11. Roger Griffin. *Fascism*, (Oxford Readers), (1995).
12. Kurt P. Tauber. *Beyond Eagle and Swastika: German nationalism since 1945*, (Wesleyan University Press; [1st ed.] edition, (1967).
13. Philip Rees, editor, *Biographical Dictionary of the Extreme Right Since 1890*, (1991).
14. *Hitler's Priestess: Savitri Devi, the Hindu-Aryan Myth, and Neo-Nazism* by Nicholas Goodrick-Clarke (1998).
15. Kevin Coogan, *Dreamer of the Day: Francis Parker Yockey and the Postwar Fascist International*, Autonomedia, Brooklyn, NY, (1998).
16. William H. Schmalz. *Hate: George Lincoln Rockwell and the American Nazi Party*, Potomac Books, (2000).
17. Frederick J. Simonelli. *American Fuehrer: George Lincoln Rockwell and the American Nazi Party*, University of Illinois Press, (1999).
18. Richard C. Thurlow. *Fascism in Britain: A History, 1918-1985*, Olympic Marketing Corp, (1987).
19. Angelo Del Boca and Mario Giovana. *Fascism Today: A World Survey*, Pantheon Books, 1st American edition, (1969).
20. Anglo-Jewish Association. *Germany's New Nazis*, Jewish Chronicle Publications, (1951).
21. Tete Harens Tetens. *The New Germany and the Old Nazis*, Random House, (1961).
22. Clifford L Linedecker. *Swastika and the Eagle: Neo-Naziism in America Today*, A & W Pub, (1982).

23. Kevin Flynn and Gary Gerhardt. *The Silent Brotherhood: Inside America's Racist Underground*, Signet Book; Reprint edition, (1995).
24. James Ridgeway. *Blood in the Face: The Ku Klux Klan, Aryan Nations, Nazi Skinheads, and the Rise of a New White Culture*, Thunder's Mouth Press; 2nd edition, (1995).
25. Elinor Langer. *A Hundred Little Hitlers: The Death of a Black Man, the Trial of a White Racist, and the Rise of the Neo-Nazi Movement in America*, Metropolitan Books, (2003).
26. Raphael S. Ezekiel. *The Racist Mind: Portraits of American Neo-Nazis and Klansmen*, Penguin (Non-Classics); Reprint edition, (1996).
27. Nicholas Goodrick-Clarke. *Black Sun: Aryan Cults, Esoteric Nazism and the Politics of Identity*, (2001).
28. Paul Hokenos. *Free to Hate: The Rise of the Right in Post-Communist Eastern Europe*, (Routledge; Reprint edition, (1994).

Chapter 7

APACOLYPTIC LOSS OF BIODIVERSITY

7.1 A new mass extinction

In geologically-observed extinction events, such as the Permian-Triassic Extinction, more than 90 percent of all terrestrial vertebrates and marine species were lost forever. It may be that our present episode of human-caused climate change will ultimately lead to a similar mass extinction; but we can already see an alarming loss of biodiversity as the result of human activities such as over-use of pesticides and encroachment on habitat. A new mass extinction has already started.

Introduction

Scientists warn that if the transition to renewable energy does not happen within very few decades, there is a danger that we will reach a tipping point beyond which feedback loops, such as the albedo effect and the methane hydrate feedback loop, will take over and produce an out-of-control and fatal increase in global temperature.

In 2012, the World Bank issued a report warning that without quick action to curb CO₂ emissions, global warming is likely to reach 4 °C during the 21st century. This is dangerously close to the temperature which initiated the Permian-Triassic extinction event: 6 °C above normal. During the Permian-Triassic extinction event, which occurred 252 million years ago, 96% of all marine species were wiped out, as well as 70% of all terrestrial vertebrates.¹

¹<http://science.nationalgeographic.com/science/prehistoric-world/permian-extinction/>
<http://www.worldbank.org/en/news/feature/2012/11/18/Climate-change-report-warns-dramatically-warmer-world-this-century>

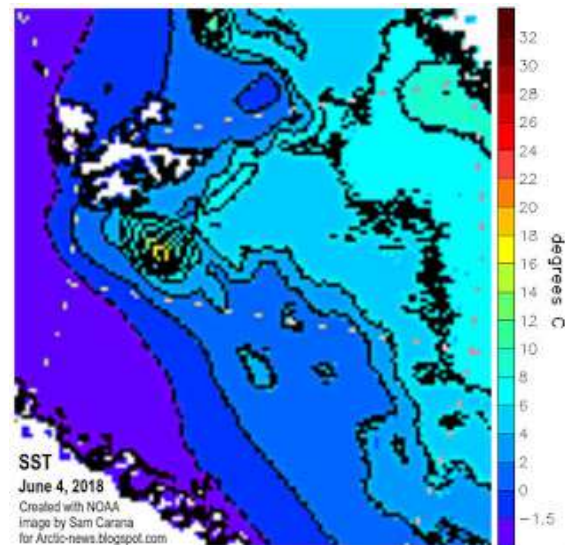

Figure 7.1: Near Svalbard, north of the Arctic Circle, water was as warm as 16.1°C or 61°F on June 4, 2018, versus 3°C or 37.4°F in 1981-2011.

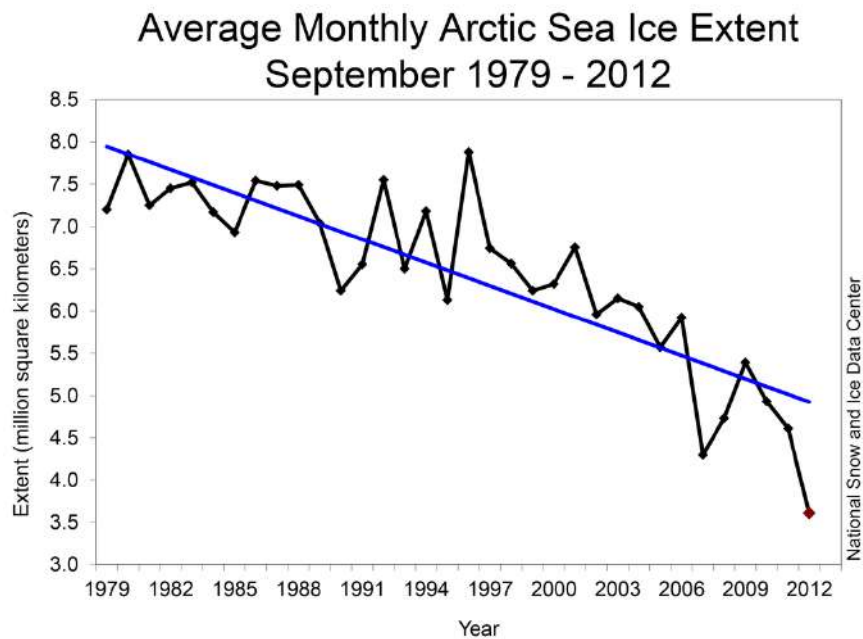

Figure 7.2: Monthly September ice extent for 1979 to 2012 shows a decline of **13.0%** per decade. One can also see that the straight line does not really fit the data, which more nearly resemble a downward curve will that reach zero in the period 2016-2019. Source: National Snow and Ice Data Center. Wikimedia Commons

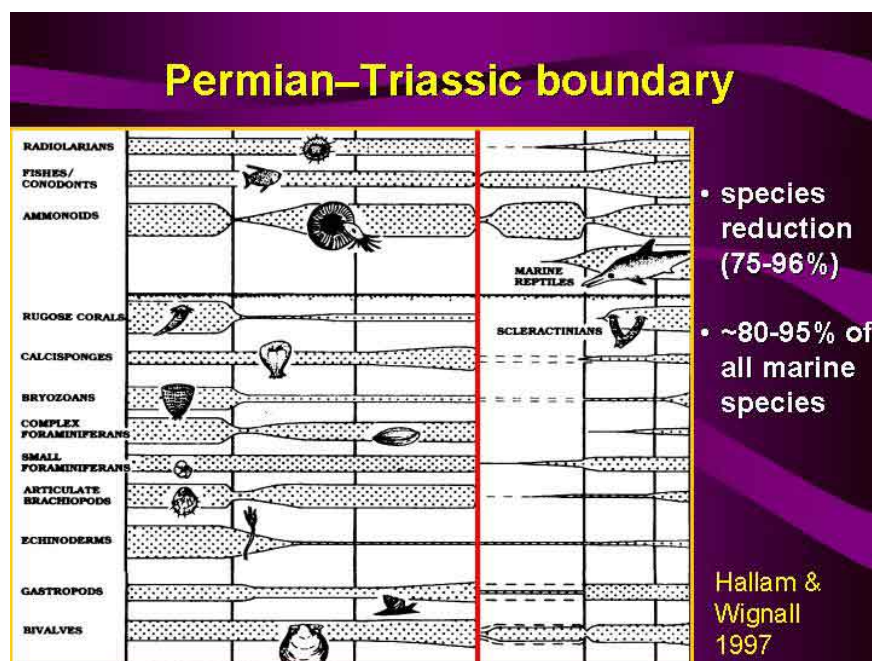

Figure 7.3: Loss of species caused by the Permian-Triassic extinction event. Unless quick steps are taken to lower our greenhouse gas emissions, we may cause a similar extinction event, which will threaten the survival of our own species. Source: Australian Frontiers of Science, www.sciencearchive.org.au

7.2 A warning from the World Bank

In 2012, the World Bank issued a report warning that without quick action to curb CO₂ emissions, global warming is likely to reach 4 °C during the 21st century. This is dangerously close to the temperature which initiated the Permian-Triassic extinction event: 6 °C above normal. During the Permian-Triassic extinction event, which occurred 252 million years ago, 96% of all marine species were wiped out, as well as 70% of all terrestrial vertebrates.²

The 4°C scenarios are devastating: the inundation of coastal cities; increasing risks for food production potentially leading to higher malnutrition rates; many dry regions becoming dryer, wet regions wetter; unprecedented heat waves in many regions, especially in the tropics; substantially exacerbated water scarcity in many regions; increased frequency of high-intensity tropical cyclones; and irreversible loss of biodiversity, including coral reef systems.

And most importantly, a 4°C world is so different from the current one that it comes with high uncertainty and new risks that threaten our ability to anticipate and plan for future adaptation needs. The lack of action on climate change not only risks putting prosperity out of reach of millions of people in the developing world, it threatens to roll back decades of sustainable development. It is clear that we already know a great deal about the threat before us. The science is unequivocal that humans are the cause of global warming, and major changes are already being observed: global mean warming is 0.8°C above pre industrial levels; oceans have warmed by 0.09°C since the 1950s and are acidifying; sea levels rose by about 20 cm since pre-industrial times and are now rising at 3.2 cm per decade; an exceptional number of extreme heat waves occurred in the last decade; major food crop growing areas are increasingly affected by drought.

Despite the global community's best intentions to keep global warming below a 2°C increase above pre-industrial climate, higher levels of warming are increasingly likely. Scientists agree that countries' current United Nations Framework Convention on Climate Change emission pledges and commitments would most likely result in 3.5 to 4°C warming. And the longer those pledges remain unmet, the more likely a 4°C world becomes.

Data and evidence drive the work of the World Bank Group. Science reports, including those produced by the Intergovernmental Panel on Climate Change, informed our decision to ramp up work on these issues, leading to, a World Development Report on climate change designed to improve our understanding of the implications of a warming planet; a Strategic Framework on Development and Climate Change, and a report on Inclusive Green Growth. The World Bank is a leading advocate for ambitious action on climate change, not only because it is a moral imperative, but because it makes good economic sense.

But what if we fail to ramp up efforts on mitigation? What are the implications of a 4°C world? We commissioned this report from the Potsdam Institute for Climate Impact

²<http://science.nationalgeographic.com/science/prehistoric-world/permian-extinction/>
<http://www.worldbank.org/en/news/feature/2012/11/18/Climate-change-report-warns-dramatically-warmer-world-this-century>

Research and Climate Analytics to help us understand the state of the science and the potential impact on development in such a world.

It would be so dramatically different from today's world that it is hard to describe accurately; much relies on complex projections and interpretations. We are well aware of the uncertainty that surrounds these scenarios and we know that different scholars and studies sometimes disagree on the degree of risk. But the fact that such scenarios cannot be discarded is sufficient to justify strengthening current climate change policies. Finding ways to avoid that scenario is vital for the health and welfare of communities around the world. While every region of the world will be affected, the poor and most vulnerable would be hit hardest. A 4°C world can, and must, be avoided.

The World Bank Group will continue to be a strong advocate for international and regional agreements and increasing climate financing. We will redouble our efforts to support fast growing national initiatives to mitigate carbon emissions and build adaptive capacity as well as support inclusive green growth and climate smart development. Our work on inclusive green growth has shown that, through more efficiency and smarter use of energy and natural resources, many opportunities exist to drastically reduce the climate impact of development, without slowing down poverty alleviation and economic growth.

This report is a stark reminder that climate change affects everything. The solutions don't lie only in climate finance or climate projects. The solutions lie in effective risk management and ensuring all our work, all our thinking, is designed with the threat of a 4°C degree world in mind. The World Bank Group will step up to the challenge.

7.3 Permian-Triassic extinction event

The geological record shows five major extinction events.

- Ordovician-Silurian Extinction. around 439 million years ago.
- Late Devonian Extinction. 375-360 million years ago.
- Permian-Triassic extinction. 352 million years ago.
- Triassic-Jurassic extinction, 201 million years ago.
- Cretaceous-Paleogene extinction, 66 million years ago.

The most devastating of these was the Permian-Triassic extinction, which occurred 252 million years ago.³ In the Permian-Triassic extinction, 96% of all marine species and 76% of all terrestrial vertebrates disappeared forever. The cause of this extremely severe

³ <https://www.thomhartmann.com/bigpicture/last-hours-climate-change>
The Last Hours of Humanity: Warming the World To Extinction (book), by Thom Hartmann
<https://www.amazon.com/Last-Hours-Humanity-Warming-Extinction/dp/1629213640>
<http://www.mediaite.com/online/leonardo-dicaprio-boosts-thom-hartmann-apocalyptic-global-warming-film-last-hours/>

event is disputed, but according to one of the most plausible theories it was triggered by a massive volcanic eruption in Siberia, which released enormous amounts of CO₂ into the earth's atmosphere.

The region where massive volcanic eruptions are known to have occurred 252 million years ago called the "Siberian Traps". (The "Traps" part of the name comes from the fact that many of the volcanic rock formations in the region resemble staircases. The Swedish word for staircase is "trappe".) The eruptions continued for about a million years.

Today the area covered is about 2 million square kilometers, roughly equal to western Europe in land area. Estimates of the original coverage are as high as 7 million square kilometers. The original volume of lava is estimated to range from 1 to 4 million cubic kilometers.

The CO₂ released by the Siberian Traps eruption is believed to have caused a global temperature increase of 6°C, and this was enough to trigger the methane-hydrate feedback loop, which will be discussed below, The earth's temperature is thought to have continued to rise for 85,000 years, finally reaching 15° above normal.

7.4 The Holocene (Anthropocene) extinction

We are now living in the midst of a sixth, human-caused, mass extinction. How severe it becomes is up to us.

Recently a group of scientists stated that the scope of human impact on planet Earth is so great that the *Anthropocene* warrants a formal place in the Geological Time Scale.

In a statement issued by University of Leicester Press Office on 2 October 2017, professor Jan Zalasiewicz from the University of Leicester's School of Geography, Geology, and the Environment said: "Our findings suggest that the Anthropocene should follow on from the Holocene Epoch that has seen 11.7 thousand years of relative environmental stability, since the retreat of the last Ice Age, as we enter a more unstable and rapidly evolving phase of our planet's history,"⁴

"We conclude that human impact has now grown to the point that it has changed the course of Earth history by at least many millennia, in terms of the anticipated long-term climate effects (e.g. postponement of the next glacial maximum: see Ganopolski et al., 2016; Clark et al., 2016), and in terms of the extensive and ongoing transformation of the biota, including a geologically unprecedented phase of human-mediated species invasions, and by species extinctions which are accelerating (Williams et al., 2015, 2016)."

The report stated that defining characteristics of the period include "marked acceleration of rates of erosion and sedimentation; large-scale chemical perturbations to the cycles of carbon, nitrogen, phosphorus and other elements; the inception of significant change in global climate and sea level; and biotic changes including unprecedented levels of species invasions across the Earth. Many of these changes are geologically long-lasting, and some are effectively irreversible."

⁴<http://www2.le.ac.uk/offices/press/press-releases/2017/october/significant-scale-of-human-impact-on-planet-has-changed-course-of-earth2019s-history-scientists-suggest>

Loss of biodiversity

Tropical rain forests are the most biologically diverse places in the world. This is because they have not been affected by the periods of glaciation that have periodically destroyed the forests of temperate and boreal regions. The destruction of species-rich tropical rain forests is one of the mechanisms driving the present high rate of species loss.

According to a recent article published in *The Guardian*⁵ “Conservation experts have already signalled that the world is in the grip of the “sixth great extinction” of species, driven by the destruction of natural habitats, hunting, the spread of alien predators and disease, and climate change.

“The IUCN⁶ created shock waves with its major assessment of the world’s biodiversity in 2004, which calculated that the rate of extinction had reached 100-1,000 times that suggested by the fossil records before humans.

“No formal calculations have been published since, but conservationists agree the rate of loss has increased since then, and Stuart said it was possible that the dramatic predictions of experts like the renowned Harvard biologist E O Wilson, that the rate of loss could reach 10,000 times the background rate in two decades, could be correct.”

A recent article by Profs. Gerardo Ceballos, Paul R. Ehrlich and Rodolfo Dirzo in the *Proceedings of the National Academy of Sciences* was entitled “Biological Annihilation via the Ongoing Sixth Mass Extinction Signaled by Vertebrate Population Losses and Declines”.

The Abstract of the paper reads as follows: “The population extinction pulse we describe here shows, from a quantitative viewpoint, that Earth’s sixth mass extinction is more severe than perceived when looking exclusively at species extinctions. Therefore, humanity needs to address anthropogenic population extirpation and decimation immediately. That conclusion is based on analyses of the numbers and degrees of range contraction (indicative of population shrinkage and/or population extinctions according to the International Union for Conservation of Nature) using a sample of 27,600 vertebrate species, and on a more detailed analysis documenting the population extinctions between 1900 and 2015 in 177 mammal species. We find that the rate of population loss in terrestrial vertebrates is extremely high, even in ‘species of low concern.’ In our sample, comprising nearly half of known vertebrate species, 32% (8,851/27,600) are decreasing; that is, they have decreased in population size and range. In the 177 mammals for which we have detailed data, all have lost 30% or more of their geographic ranges and more than 40% of the species have experienced severe population declines (>80% range shrinkage). Our data indicate that beyond global species extinctions Earth is experiencing a huge episode of population declines and extirpations, which will have negative cascading consequences on ecosystem functioning and services vital to sustaining civilization. We describe this as a ‘biological annihilation’ to highlight the current magnitude of Earth’s ongoing sixth major extinction event.”

⁵<https://www.theguardian.com/environment/2010/mar/07/extinction-species-evolve>

⁶International Union for the Conservation of Nature

7.5 Global warming and atmospheric water vapor

A feedback loop is a self-re-enforcing trend. One of the main positive feedback loops in global warming is the tendency of warming to increase the atmospheric saturation pressure for water vapor, and hence amount of water vapor in the atmosphere, which in turn leads to further warming, since water vapor is a greenhouse gas.

Wikipedia's article on greenhouse gases states that, "Water vapor accounts for the largest percentage of the greenhouse effect, between 36% and 66% for clear sky conditions and between 66% and 85% when including clouds."

7.6 The albedo effect

Albedo is defined to be the fraction of solar energy (shortwave radiation) reflected from the Earth back into space. It is a measure of the reflectivity of the earth's surface. Ice, especially with snow on top of it, has a high albedo: most sunlight hitting the surface bounces back towards space.

Loss of sea ice

Especially in the Arctic and Antarctic regions, there exists a dangerous feedback loop involving the albedo of ice and snow. As is shown in Figure 4.1, Arctic sea ice is rapidly disappearing. It is predicted that during the summers, the ice covering arctic seas may disappear entirely during the summers. As a consequence, incoming sunlight will encounter dark light-absorbing water surfaces rather than light-reflecting ice and snow.

This effect is self-re-enforcing. In other words, it is a feedback loop. The rising temperatures caused by the absorption of more solar radiation cause the melting of more ice, and hence even more absorption of radiation rather than reflection, still higher temperatures, more melting, and so on.

The feedback loop is further strengthened by the fact that water vapor acts like a greenhouse gas. As polar oceans become exposed, more water vapor enters the atmosphere, where it contributes to the greenhouse effect and rising temperatures.

Darkened snow on Greenland's icecap

Greenland's icecap is melting, and as it melts, the surface becomes darker and less reflective because particles of soot previously trapped in the snow and ice become exposed. This darkened surface absorbs an increased amount of solar radiation, and the result is accelerated melting.

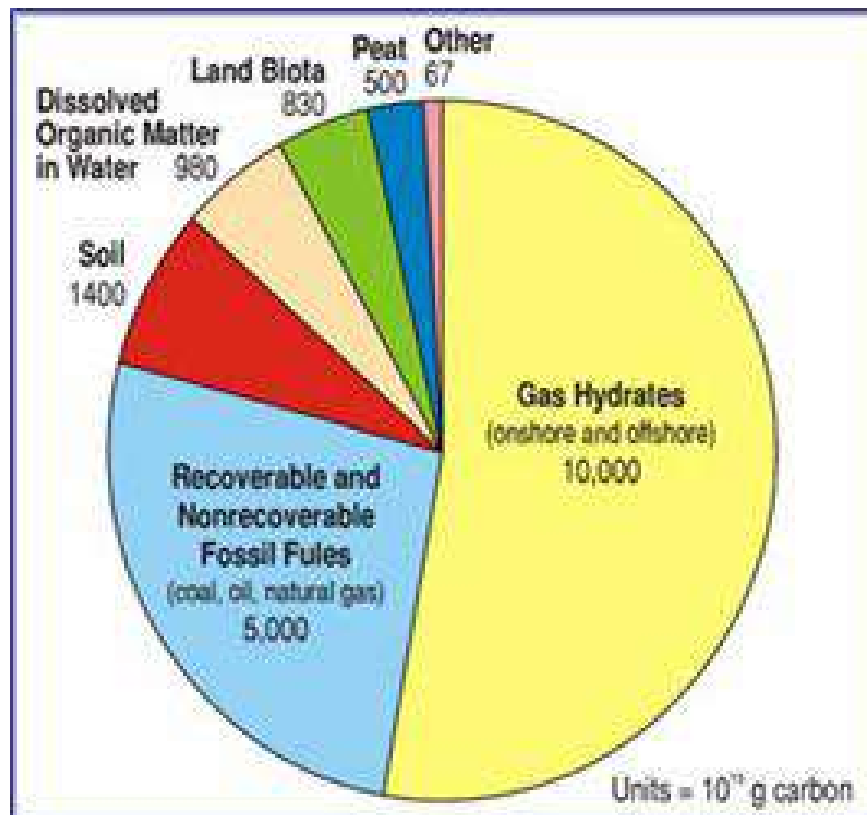

Figure 7.4: The worrying thing about the methane/hydrate feedback loop is the enormous amount of carbon in the form of hydrate crystals, 10,000 gigatons most of it on the continental shelves of oceans. This greater than the amount of carbon in all other forms that might potentially enter the earth's atmosphere.



Figure 7.5: When ocean temperatures rise, methane hydrate crystals become unstable, and methane gas bubbles up to ocean surfaces.

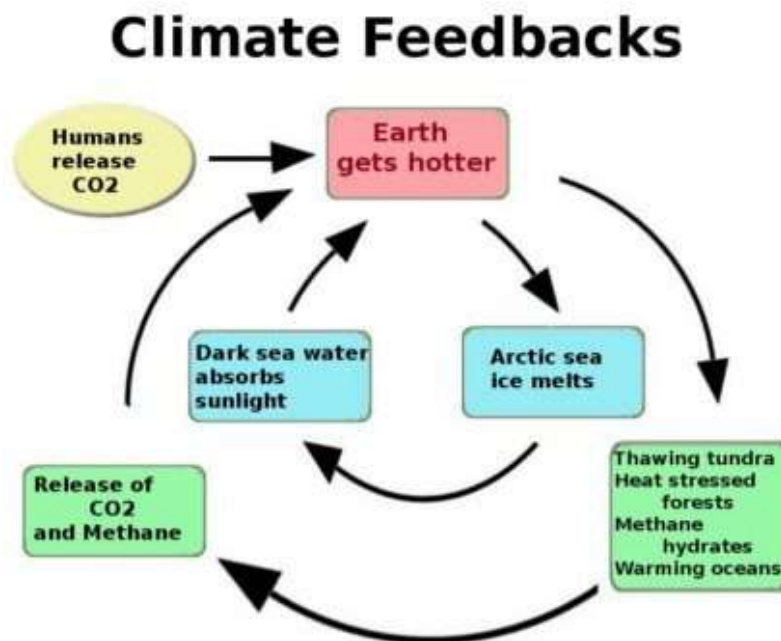

Figure 7.6: This diagram shows two important feedback loops, one involving the albedo effect, and the other involving methane hydrates.

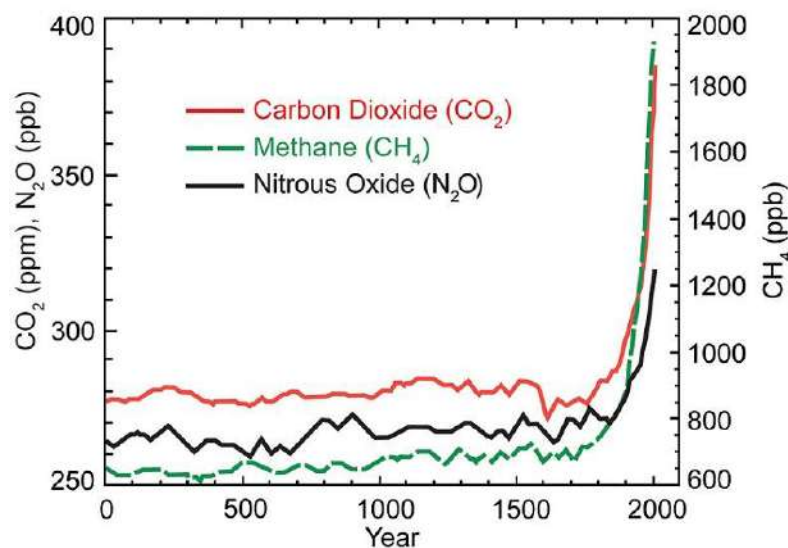

Figure 7.7: A “hockey stick” graph showing atmospheric concentrations of three important greenhouse gases during the last 2,000 years. The most dramatically increasing of these is methane.

7.7 The methane hydrate feedback loop

If we look at the distant future, by far the most dangerous feedback loop involves methane hydrates or methane clathrates. When organic matter is carried into the oceans by rivers, it decays to form methane. The methane then combines with water to form hydrate crystals, which are stable at the temperatures and pressures which currently exist on ocean floors. However, if the temperature rises, the crystals become unstable, and methane gas bubbles up to the surface. Methane is a greenhouse gas which is 70 times as potent as CO₂.

The worrying thing about the methane hydrate deposits on ocean floors is the enormous amount of carbon involved: roughly 10,000 gigatons. To put this huge amount into perspective, we can remember that the total amount of carbon in world CO₂ emissions since 1751 has only been 337 gigatons.

A runaway, exponentially increasing, feedback loop involving methane hydrates could lead to one of the great geological extinction events that have periodically wiped out most of the animals and plants then living. This must be avoided at all costs.

7.8 A feedback loop from warming of soils

On October 6, 2017, the journal *Science* published an article entitled *Long-term pattern and magnitude of soil carbon feedback to the climate system in a warming world*⁷. The

⁷J.M. Melillo et al., *Long-term pattern and magnitude of soil carbon feedback to the climate system in a warming world*, *Science*, Vol. 358, pp. 101-105, (2017).

lead author, Jerry Melillo, is an ecologist working at the Marine Biological Laboratory, Woods Hole Massachusetts. In an interview with *Newsweek*, he said: “This self-reinforcing feedback is potentially a global phenomenon with soils, and once it starts it may be very difficult to turn off. It’s that part of the problem that I think is sobering... We think that one of the things that may be happening is both a reorganization of the microbial community structure and its functional capacity,”

The study reported on three decades of observations of heated sections of a forest owned by Harvard University. The heated sections were 5°C warmer than control sections.

7.9 Drying of forests and forest fires

According to a recent article in *Nature*⁸, “Across the American west, the area burned each year has increased significantly over the past several decades, a trend that scientists attribute both to warming and drying and to a century of wildfire suppression and other human activities. Allen suggests that the intertwined forces of fire and climate change will take ecosystems into new territory, not only in the American west but also elsewhere around the world. In the Jemez, for example, it could transform much of the ponderosa pine (*Pinus ponderosa*) forest into shrub land. ‘We’re losing forests as we’ve known them for a very long time,’ says Allen. ‘We’re on a different trajectory, and we’re not yet sure where we’re going.’

“All around the American west, scientists are seeing signs that fire and climate change are combining to create a ‘new normal’. Ten years after Colorado’s largest recorded fire burned 56,000 hectares southwest of Denver, the forest still has not rebounded in a 20,000-hectare patch in the middle, which was devastated by an intense crown fire. Only a few thousand hectares, which the US Forest Service replanted, look anything like the ponderosa-pine stands that previously dominated the landscape.”

⁸<http://www.nature.com/news/forest-fires-burn-out-1.11424>



Figure 7.8: Maude Barlow (born 1947). The Wikipedia article on her states that she is a “Canadian author and activist. She is the National Chairperson of the Council of Canadians, a citizens’ advocacy organization with members and chapters across Canada. She is also the co-founder of the Blue Planet Project, which works internationally for the human right to water. Maude chairs the board of Washington-based Food and Water Watch, is a founding member of the San Francisco-based International Forum on Globalization, and a Councillor with the Hamburg-based World Future Council. In 2008/2009, she served as Senior Advisor on Water to the 63rd President of the United Nations General Assembly and was a leader in the campaign to have water recognized as a human right by the UN. She has authored and co-authored 16 books.” Maude Barlow’s work on the issue of water is especially important because fresh water is becoming increasingly scarce throughout the world.

7.10 Tipping points and feedback loops

A tipping point is usually defined as the threshold for an abrupt and irreversible change⁹. To illustrate this idea, we can think of a book lying on a table. If we gradually push the book towards the edge of the table, we will finally reach a point after which more than half of the weight of the book will not be supported by the table. When this “tipping point” is passed the situation will suddenly become unstable, and the book will fall to the floor. Analogously, as the earth’s climate gradually changes, we may reach tipping points. If we pass these points, sudden instabilities and abrupt climatic changes will occur.

Greenland ice cores supply a record of temperatures in the past, and through geological evidence we have evidence of sea levels in past epochs. These historical records show that abrupt climatic changes have occurred in the past.

Timothy Michael Lenton, FRS, Professor of Climate Change and Earth System Science at the University of Exeter, lists the following examples of climatic tipping points:

- Boreal forest dieback
- Amazon rainforest dieback
- Loss of Arctic and Antarctic sea ice (Polar ice packs) and melting of Greenland and Antarctic ice sheets
- Disruption to Indian and West African monsoon
- Formation of Atlantic deep water near the Arctic ocean, which is a component process of the thermohaline circulation.
- Loss of permafrost, leading to potential Arctic methane release and clathrate gun effect

It can be seen from this list that climate tipping points are associated with feedback loops. For example, the boreal forest dieback and the Amazon rainforest dieback tipping points are associated with the feedback loop involving the drying of forests and forest fires, while the tipping point involving loss of Arctic and Antarctic sea ice is associated with the Albedo effect feedback loop. The tipping point involving loss of permafrost is associated with the methane hydrate feedback loop.

Once a positive feedback loop starts to operate in earnest, change may be abrupt.

⁹Other definitions of tipping points are possible. A few authors define these as points beyond which change is inevitable, emphasizing that while inevitable, the change may be slow.



Figure 7.9: Fighting a fire in California, caused by the unusually hot and dry weather of the summer of 2018. The very dry weather also caused uncontrollable fires in the Arctic, in Sweden, Russia, Northern Canada and Alaska.

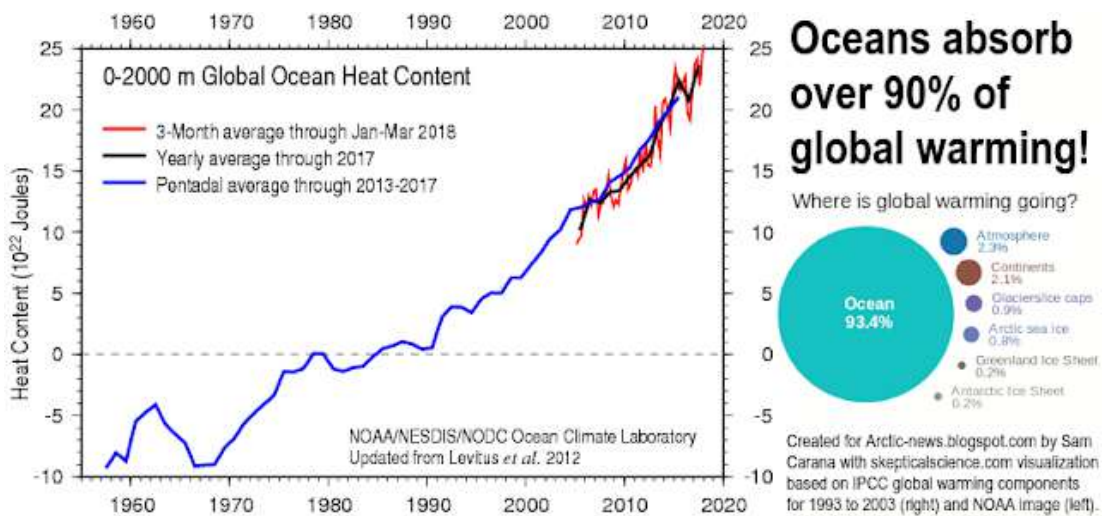

Figure 7.10: The heat content of the oceans is rapidly increasing.

7.11 Climate change denial

In a recent article, climate expert Dr. Andrew Glickson wrote: “The train has left the station and global heating is advancing toward +2 and then toward +4 degrees Celsius, as projected by the IPCC and in the words of Joachim Hans Schellnhuber, Germany’s chief climate scientist, signifies the breakdown of civilization. Largely ignored or watered down by much of the mainstream media, betrayed by most political parties, including those who used to regard climate change as “the greatest moral issue of our time”, the population continues to be distracted by bread and circuses. Nowadays even some of the Greens appear to consider plastic bags and the tampon tax as greater vote winners than the demise of the biosphere.”

Why did Professor Noam Chomsky call the US Republican Party “The most dangerous organization in the history of the world”? In the primary that preceded the 2016 presidential election, every single Republican candidate with a chance of being nominated was a climate change denier. All received amazingly generous checks from giant fossil fuel organizations. When elected, Donald Trump not only pulled the United States out of the Paris Agreement; he also sabotaged the Environmental Protection Agency to such an extent that the carefully collected facts on climate change that the agency had accumulated had to be secretly saved by scientists to prevent their destruction by the Trump administration. Furthermore, Donald Trump not only subsidizes giant coal corporations. He also has sabotages renewable energy initiatives in the United States.

7.12 Humanity betrayed by the mass media

The predicament of humanity today has been called “a race between education and catastrophe”: How do the media fulfil this life-or-death responsibility? Do they give us insight? No, they give us pop music. Do they give us an understanding of the sweep of evolution and history? No, they give us sport. Do they give us an understanding of the ecological catastrophes that threaten our planet because of unrestricted growth of population and industries? No, they give us sit-coms and soap operas. Do they give us unbiased news? No, they give us news that has been edited to conform with the interests of powerful lobbys. Do they present us with the urgent need to leave fossil fuels in the ground? No, they do not, because this would offend the powerholders. Do they tell of the danger of passing tipping points after which human efforts to prevent catastrophic climate change will be useless? No, they give us programs about gardening and making food.

A consumer who subscribes to the “package” of broadcasts sold by a cable company can often search through all 95 channels without finding a single program that offers insight into the various problems that are facing the world today. What the viewer finds instead is a mixture of pro-establishment propaganda and entertainment. Meanwhile the neglected global problems are becoming progressively more severe.

In general, the mass media behave as though their role is to prevent the peoples of the world from joining hands and working to change the world and to save it from thermonu-

clear war, environmental catastrophes and threatened global famine. The television viewer sits slumped in a chair, passive, isolated, disempowered and stupefied. The future of the world hangs in the balance, the fate of children and grandchildren hangs in the balance, but the television viewer feels no impulse to work actively to change the world or to save it. The Roman emperors gave their people bread and circuses to numb them into political inactivity. The modern mass media seem to be playing a similar role.

The most dangerous idea that the mass media peddle to a betrayed world is the there is no emergency, no crisis of civilization. Everything is fundamentally normal. We can continue to behave more or less as we always have behaved. We can continue to extract and use fossil fuels, continue to fly to vacations in foreign countries, and continue to rely on our trusted and most loved friend, the private automobile. But this is a lie. They are lying to us because no one wants to shoot Santa Claus. No one wants to undermine “consumer confidence”.

The true situation is that the future looks extremely dark, especially the long-term future, because of human greed and folly. The greatest threats are catastrophic climate change and thermonuclear war, but a large-scale global famine also has to be considered.

We give our children loving care, but it makes no sense do so and at the same time to neglect to do all that is within our power to ensure that they and their descendants will inherit an earth in which they can survive. We also have a responsibility to all the other living organisms with which we share the gift of life.

Inaction is not an option. We have to act with courage and dedication, even if the odds are against success, because the stakes are so high. No one is exempt from this duty. Every singly person on earth has the duty to work with dedication and courage to save the future.

None of us asked to be born at a time of crisis. But we have been born at such a time, and history has given us an enormous responsibility. If we do not work with courage and dedication to save our beautiful world for future generations, all the treasures that past generations have given us will be lost.

What are the great tasks that history has given to us? If true democracy has decayed into oligarchy in our own countries, democracy must be restored. Global population must be stabilized, and in the long run, reduced. Nuclear weapons must be completely abolished. The institution of war must be abolished by turning the United Nations into a federation. Our consumption of fossil fuels must quickly end, through changes in lifestyle, and through an all-out effort to rapidly develop renewable energy.

Soldiers in war are asked to give their lives for their countries. We, who are opposed to war, must be equally willing to devote our lives to a cause - the cause of saving civilization - the cause of saving the the biosphere - the cause of saving the future.

7.13 From child author to marine biologist

Love of nature passed from mother to daughter

Rachel Carson (1907-1964) was born on her family's 65-acre farm near Springdale Pennsylvania. Although the farm was a large one, the family's home had no indoor plumbing and no electricity. Before her marriage, Rachel's mother had been an accomplished singer and musician, as well as a teacher. A special love for nature was transmitted from mother to daughter. During Rachel's early childhood, the two spent much time together exploring and enjoying the plants and animals on the family farm.

A published author at the age of 10

As a child, Rachel Carson was an avid reader. Her favorite author was Beatrix Potter, and her favorite story was Kenneth Grahame's *The Wind in the Willows*. She also began to write stories at the age of 8. By the time she was 10 years old, she was being paid for the publication of the stories by St. Nicholas Magazine.

Graduating at the top of her class

At school in Springdale, Rachel received straight A's and graduates at the top of her class. Her mother was anxious that her clever daughter should have the opportunity to develop her full potential. Both parents made considerable sacrifices to give their daughter the education that her abilities deserved, and in 1929 she graduated (again at the top of her class) from the elite Pennsylvania College for Women in Pittsburgh. She had started her studies as an English major, but later switched to biology.

The Great Depression was just starting, and although Rachel Carson enrolled for post-graduate studies at Johns Hopkins University, she was soon forced stop her studies and find work to support her mother (who was alone, following the death of Rachel's father). She was hired by the US Fish and Wildlife Service.



Figure 7.11: As a child, Rachel Carlson was fond of animals, and of writing. At the age of 10, she was earning money from the publication of her stories!



Figure 7.12: Rachel Carson graduated *magnum cum laude* from the Pennsylvania College for Women in 1929. She also took postgraduate courses at Johns Hopkins University, but was forced to leave without a degree in order to support her aging mother during the Great Depression.



Figure 7.13: Rachel Carson in 1940 (U.S. Fish and Wildlife Service employee photo). She came first, among all other applicants, on the Civil Service examination that won her the position.

7.14 The Sea Around Us

An earlier book

The Sea Around Us was Rachel Carson's second book. Earlier, in 1941, her book *Under the Sea Wind* had been published by Simon and Schuster. It had won critical acclaim, but had sold poorly. In 1948, Carson began writing a sequel, which she at first planned to call *Return to the Sea*. A chapter entitled *The Birth of an Island* attracted the favorable attention of publishers and periodicals.

Rachel Carson becomes a best-selling author

In June 1950, Rachel Carson finally completed the sequel to her first book. It was now renamed *The Sea Around Us*. Before its publication, nine of the fourteen chapters of the book were serialized in *The New Yorker*, while the chapter on *The Birth of an Island* was published by *The Yale Review*, where it won the the George Westinghouse Science Writing prize from the American Association for the Advancement of Science. The entire book was published on July 2, 1951, by Oxford University Press. Rachel Carson was immediately inundated by fan mail and media attention. The book won both the 1952 National Book Award for Nonfiction and a Burroughs Medal in nature writing. It remained on the New York Times Best Seller List for 86 weeks and it has been translated into 28 languages. A condensation of *The Sea Around Us*, published by *The Reader's Digest*, reached an extremely wide audience. The success of this book made Rachel Carson both famous and financially independent. She quit her government job in the summer of 1952. Her forgotten first book was rediscovered, joining *The Sea Around Us* on the Best Seller List.

At the National Book Award Ceremony, Rachel Carson said: "The aim of science is to discover and illuminate truth. And that, I take it, is the aim of literature, whether biography or history or fiction. It seems to me, then, that there can be no separate literature of science".

In 1952, Carson won an award that she had coveted - the John Burroughs Medal for the most distinguished natural history book. There were also several gold medals and honorary doctorates, including one from her alma mater. Requests for TV, radio, and newspaper interviews flooded in.

A filmed version wins an Oscar

A documentary based on *The Sea Around Us*, written and produced by Irwin Allen, won the 1953 Academy Award for Best Documentary Feature, but Carson believed it was inaccurate and did not reflect her work properly. She quarreled with Irwin about the script, but discovered that her contract with him gave her no power to change anything, It was the last time she sold film rights to any of her works.

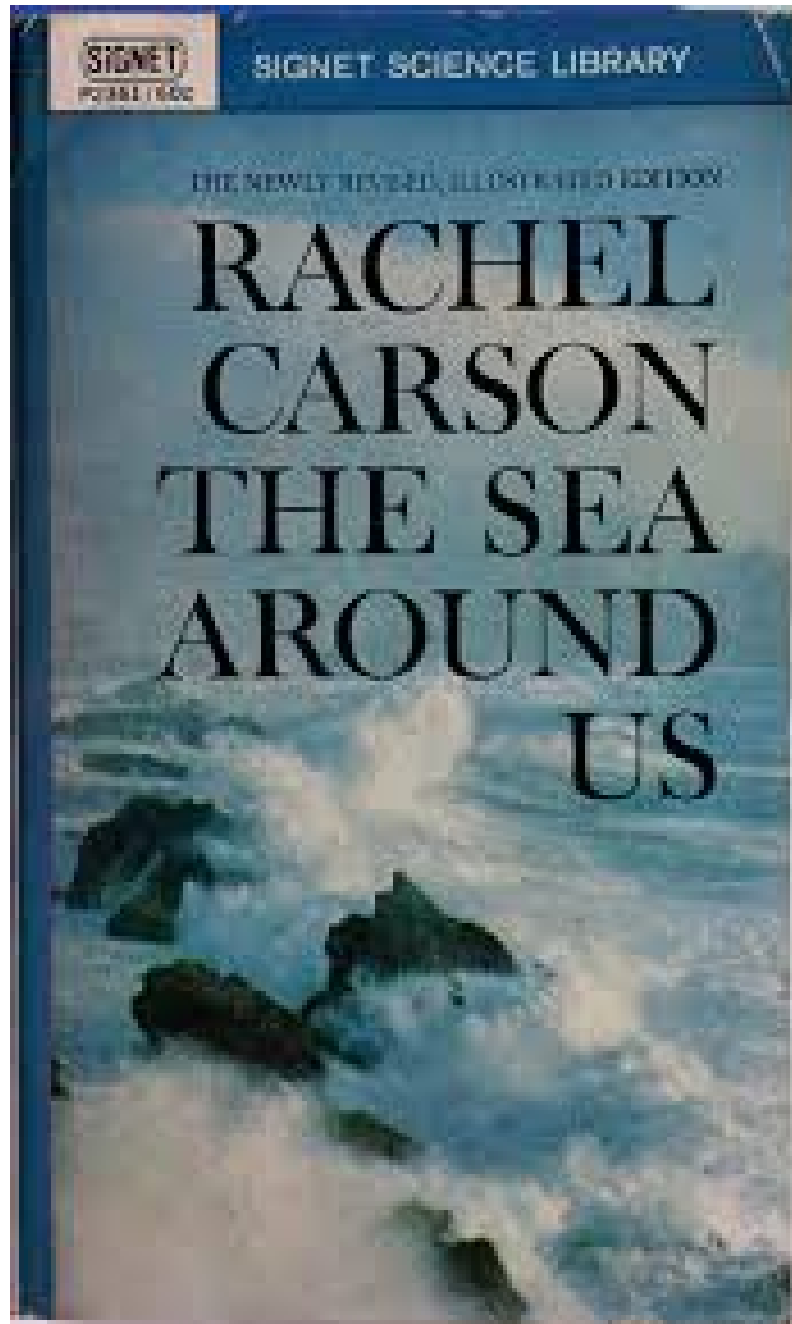

Figure 7.14: Rachel Carson's gift for writing combined with her wide knowledge of marine biology to make *The Sea Around Us* a best-seller.

7.15 The Silent Spring

Dangers from pesticide pollution

Rachel Carson's most influential book, *The Silent Spring*, was published in 1962, when she was already suffering from breast cancer. Eventually it sold over two million copies. The book expresses Carson's worries about the environmental consequences of overuse of pesticides, such as DDT, which were killing not only their targeted pests, but also many vitally important insects, as well as causing health problems in humans. Part of the anger that Carson expressed in the book may have come because the cancer from which she was suffering could have been caused by mutagenic pesticides.

The town was fictitious, but the problems were real

The Silent Spring begins by describing a fictitious Midwestern American town, where people are mysteriously suffering and dying from a variety of unexplained illnesses previously unseen by doctors. Sheep and cattle, fish in the river, and birds, all sicken and die. Orchards bear no fruit and vegetation withers. It gradually becomes clear that the people of the town are themselves to blame. That have been poisoning themselves and their environment by overuse of pesticides.

Some quotations from *The Silent Spring*

Here are two quotations from the book:

As crude a weapon as the cave man's club, the chemical barrage has been hurled against the fabric of life - a fabric on the one hand delicate and destructible, on the other miraculously tough and resilient, and capable of striking back in unexpected ways... It is our alarming misfortune that so primitive a science has armed itself with the most modern and terrible weapons, and that in turning them against the insects it has also turned them against the earth...

Among the herbicides are some that are classified as 'mutagens,' or agents capable of modifying the genes, the materials of heredity. We are rightly appalled by the genetic effects of radiation; how then, can we be indifferent to the same effect in chemicals that we disseminate widely in our environment?

Although extremely ill with cancer and in constant pain, Carson gave newspaper interviews and appeared on television to make her case. In July, 1962, the US Department of agriculture issued the following statement: **"Miss Carson provides a lucid description of the real and potential dangers of misusing chemical pesticides... She expresses the concern of many people about the effect of chemical pesticides on birds, animals and people. We are fully aware of and share this concern."**

'Silent Spring' Is Now Noisy Summer

*Pesticides Industry
Up in Arms Over
a New Book*

By JOHN M. LEE

The \$200,000,000 pesticides industry has been highly irritated by a quiet woman author whose previous works on science have been praised for the beauty and precision of the writing.

The author is Rachel Carson, whose "The Sea Around Us" and "The Edge of the Sea" were best sellers in 1951 and 1955. Miss Carson, trained as a marine biologist, wrote gracefully of sea and shore life.

In her latest work, however, Miss Carson is not so gentle,



*Rachel Carson Stirs
Conflict—Producers
Are Crying 'Foul'*

fending the use of their products. Meetings have been held in Washington and New York. Statements are being drafted and counter-attacks plotted.

A drowsy midsummer has suddenly been enlivened by the greatest uproar in the pesticides industry since the cranberry scare of 1959.

Miss Carson's new book is entitled "Silent Spring." The title is derived from an idealized situation in which Miss Carson envisions an imaginary town where chemical pollution has silenced "the voices of insects."

Figure 7.15: Rachel Carson's book, *The Silent Spring*, was controversial, to say the least, but it focused public attention on problems of ecology.

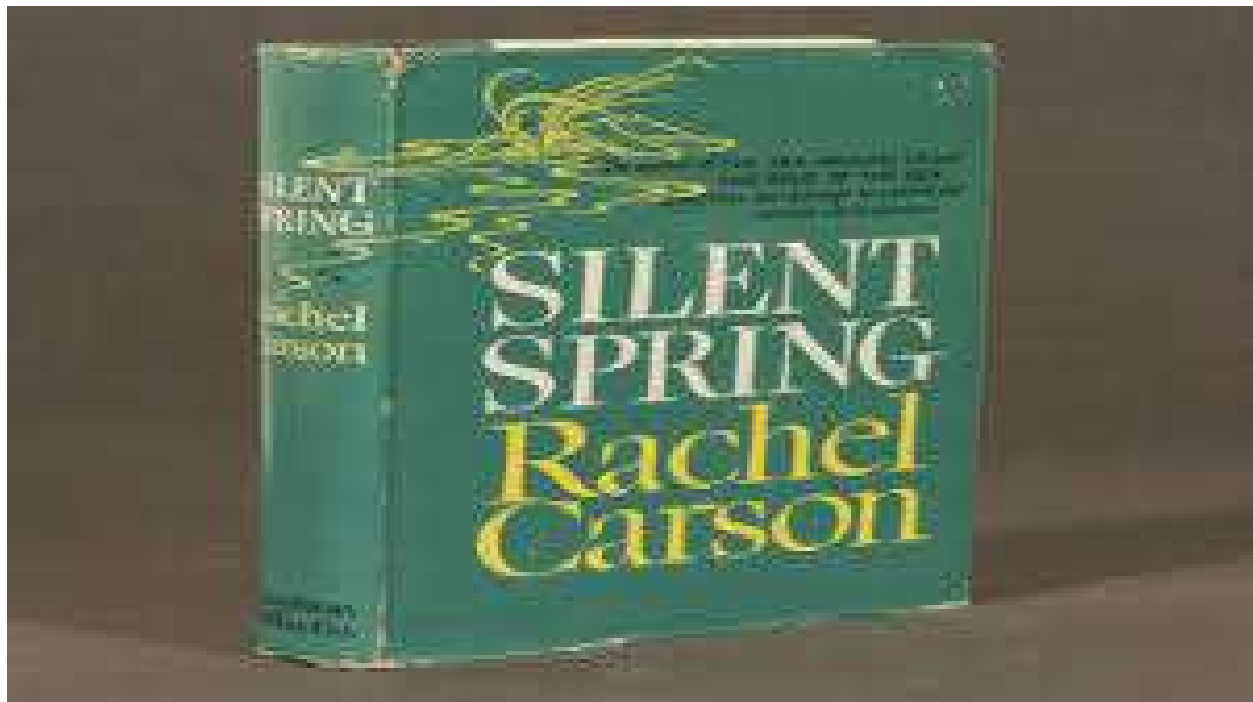

Figure 7.16: *The Silent Spring* was an international best-seller, and it ignited the environmental movement.

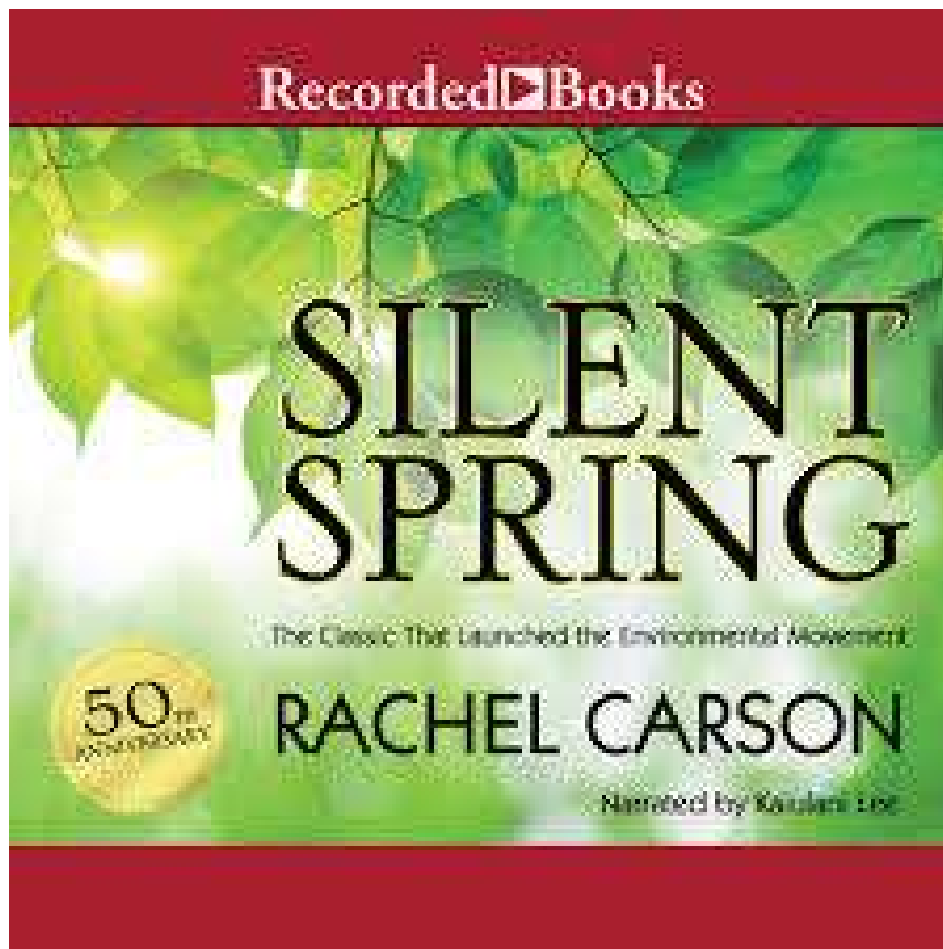

Figure 7.17: An audio version of *The Silent Spring*.



Figure 7.18: As Rachel Carson's influence increased, she began speaking to large audiences.



Figure 7.19: Statue of Carson at the Museo Rocsen, Nono, Argentina.

7.16 Overuse of pesticides and the insect apocalypse

Loss of flying insects, especially bees

Studies have shown an annual decline of 5.2% in flying insect biomass found in nature reserves in Germany - about 75% loss in 26 years.

In the United States the managed bee populations have declined dramatically. According to one study, for the single year, from April 1, 2018, to April 1, 2019, the managed bee population decreased by 40.7%.

Overuse of pesticides degrades topsoil

It is not only the loss of bees and other pollinator insects that is dangerous to agriculture. The excessive use of pesticides and other agricultural chemicals also degrades topsoil. Normally, topsoil contains richly numerous and diverse populations of tiny worms and bacteria, that aid the recycling of crop residue from previous years into nutrients for plant growth. However, the overuse of pesticides and other agricultural chemicals kills these vitally important populations. Carbon from the dead topsoil is released into the atmosphere, thus increasing the concentrations of dangerous greenhouse gases. Having killed the living topsoil, farmers then find that they need increased quantities of petroleum-derived fertilizers to make their crops grow.

The Stockholm Convention on Persistent Organic Pollutants

An environmental treaty, signed in 2001 and effective since May, 2004, aims at restricting the production and use of persistent organic pollutants (POPs). These are defined by the United Nations Environmental Institute as “chemical substances that persist in the environment, bio-accumulate through the food web, and pose a risk of causing adverse effects to human health and the environment”. Besides DDT, the Stockholm Treaty also lists Aldrin, α -Hexachlorocyclohexane, β -Hexachlorocyclohexane, Chlordane, Chlordecone, Decabromodiphenyl ether, Dicofol, Dieldrin, Endosulfan, Endrin, Heptachlor, Hexabromobiphenyl, Hexabromocyclododecane, Hexabromodiphenylether, Hexachlorobenzene, Hexachlorobutadiene, Lindane, Mirex, Pentachlorobenzene, Pentachlorophenol, Perfluorooctanoic acid, Perfluorooctane sulfonic acid, Polychlorinated biphenyls, Polychlorinated dibenzodioxins, Polychlorinated naphthalenes, Tetrabromodiphenyl ether, Short-chain chlorinated paraffins, and Toxaphene.

Although some critics have claimed that the treaty is responsible for the continuing death toll from malaria, in reality it specifically permits the public health use of DDT for the control of malaria-carrying mosquitoes. In 2016, there were 216 million cases of malaria worldwide, resulting in an estimated 445,000 to 731,000 deaths.



Figure 7.20: 20 May 2019, Rome - The global decline in bee populations poses a serious threat to a wide variety of plants critical to human well-being and livelihoods, and countries should do more to safeguard our key allies in the fight against hunger and malnutrition, FAO stressed today as it marked UN World Bee Day. Bees and other pollinator are declining in abundance in many parts of the world largely due to intensive farming practices, mono-cropping, excessive use of agricultural chemicals and higher temperatures associated with climate change, affecting not only crop yields but also nutrition. If this trend continues, nutritious crops such as fruits, nuts, and many vegetables will be substituted increasingly by staple crops like rice, corn, and potatoes, eventually resulting in an imbalanced diet.

Suggestions for further reading

1. Ehrlich P-R (1995) *The scale of the human enterprise and biodiversity loss*, in *Extinction Rates*, eds Lawton JH, May RM (Oxford Univ Press, Oxford, UK), pp 214-226.
2. Dirzo R, et al. (2014) *Defaunation in the Anthropocene*. *Science* **345**:401-406.
3. Young HS, McCauley DJ, Galletti M, Dirzo R (2016) *Patterns, causes, and consequences of Anthropocene defaunation*. *Annu Rev Ecol Evol Syst* **47**:433-458.
4. World Wide Fund for Nature (2016) *Living Planet Report 2016. Risk and resilience in a new era*. (WWF International, Gland, Switzerland), 2017.
5. Maxwell SL, Fuller RA, Brooks TM, Watson JEM (2016) *Biodiversity: The ravages of guns, nets and bulldozers*. *Nature* **536**:143-145.
6. Laliberte AS, Ripple WJ (2004) *Range contractions of North American carnivores and ungulates*. *BioScience* **54**:123-138.
7. Worm B, Tittensor DP (2011) *Range contraction in large pelagic predators*. *Proc Natl Acad Sci USA* **108**:11942-11947.
8. Ripple WJ, et al. (2014) *Status and ecological effects of the world's largest carnivores*. *Science* **343**:1241484.
9. Barnosky AD, et al. (2011) *Has the Earth's sixth mass extinction already arrived?* *Nature* **471**:51-57.
10. Ceballos G, Garcia A, Ehrlich PR (2010) *The sixth extinction crisis: Loss of animal populations and species*. *J. Cosmology* **8**:1821-1831.
11. Ceballos G, et al. (2015) *Accelerated modern human-induced species losses: Entering the sixth mass extinction*. *Sci Adv* **1**:e1400253.
12. Wake DB, Vredenburg VT (2008) *Colloquium paper: Are we in the midst of the sixth mass extinction? A view from the world of amphibians*. *Proc Natl Acad Sci USA* **105**:11466-11473.
13. McCallum ML (2015) *Vertebrate biodiversity losses point to a sixth mass extinction*. *Biol Conserv* **24**:2497-2519.
14. Pimm SL, et al. (2014) *The biodiversity of species and their rates of extinction, distribution, and protection*. *Science* **344**:1246752.
15. McCauley DJ, et al. (2015) *Marine defaunation: Animal loss in the global ocean*. *Science* **347**:1255641.
16. Collen B, Böhm M, Kemp R, Baillie J (2012) *Spineless: Status and Trends of the World's Invertebrates* (Zoological Society of London, London). Red List
17. Daily G (1997) *Nature's Services: Societal Dependence on Natural Ecosystems*. (Island Press, Covello, CA).
18. Naeem S, Duffy JE, Zavaleta E (2012) *The functions of biological diversity in an age of extinction*. *Science* **336**:1401-1406.
19. Estes JA, et al. (2011) *Trophic downgrading of planet Earth*. *Science* **333**:301-306.
20. Brosi BJ, Briggs HM (2013) *Single pollinator species losses reduce floral fidelity and plant reproductive function*. *Proc Natl Acad Sci USA* **110**:13044-13048.
21. Briggs JC (2014) *Global biodiversity gain is concurrent with decreasing population sizes*. *Biodiver J* **5**:447-452.

22. Hooper DU, et al. (2012) *A global synthesis reveals biodiversity loss as a major driver of ecosystem change*. *Nature* **486**:105-108.
23. Ehrlich PR (2014) *The case against de-extinction: It's a fascinating but dumb idea*. *Yale Environment* **360** (Yale University, New Haven, CT). Available at bit.ly/1gAIuJF. Accessed JunStudies 10, 2017.
24. Hobbs RJ, Mooney HA (1998) *Broadening the extinction debate: Population deletions and additions in California and Western Australia*. *Conserv Biol* **12**:271-283.
25. Hughes JB, Daily GC, Ehrlich PR (1997) *Population diversity: Its extent and extinction*. *Science* **278**:689-692.
26. Ceballos G, Ehrlich PR (2002) *Mammal population losses and the extinction crisis*. *Science* **296**:904-907.
27. Gaston KJ, Fuller RA (2008) *Commonness, population depletion and conservation biology*. *Trends Ecol Evol* **23**:14-19.
28. International Union of Conservation of Nature (2015) *The IUCN Red List of Threatened Species, Version 2015.2* (IUCN, 2015). Available at www.iucnredlist.org. Accessed February 10, 2016. Revised January 10, 2017.
29. Durant SM, et al. (2017) *The global decline of cheetah *Acinonyx jubatus* and what it means for conservation*. *Proc Natl Acad Sci USA* **114**:528-533.
30. Henschel P, et al. (2014) *The lion in West Africa is critically endangered*. *PLoS One* **9**:e83500.
31. Challender D, et al. (2016) *On scaling up pangolin conservation*. *Traffic Bulletin* **28**:19-21.
32. Fennessy J, et al. (2016) *Multi-locus analyses reveal four giraffe species instead of one*. *Curr Biol* **26**:2543-2549.
33. Butchart S, Dunn E (2003) *Using the IUCN Red List criteria to assess species with declining populations*. *Conserv Biol* **17**:1200-1202.
34. Gaston K, Blackburn T (2008) *Pattern and Process in Macroecology* (Blackwell Publishing, Hoboken, NJ). Red List
35. Thomas JA (2016) *ECOLOGY. Butterfly communities under threat*. *Science* **353**:216-218.
36. Régnier C, et al. (2015) *Mass extinction in poorly known taxa*. *Proc Natl Acad Sci USA* **112**:7761-7766.25.
37. Hughes JB, Daily GC, Ehrlich PR (1997) *Population diversity: Its extent and extinction*. *Science* **278**:689-692.
38. Ceballos G, Ehrlich PR (2002) *Mammal population losses and the extinction crisis*. *Science* **296**:904-907.
39. Cardinale BJ, et al. (2012) *Biodiversity loss and its impact on humanity*. *Nature* **486**: 59-67.
40. Hurlbert AH, Jetz W (2007) *Species richness, hotspots, and the scale dependence of range maps in ecology and conservation*. *Proc Natl Acad Sci USA* **104**:13384-13389.
41. Peterson AT, Navarro-Sigüenza AG, Gordillo A (2016) *Assumption- versus data-based approaches to summarizing species' ranges*. *Conserv Biol*, [10.1111/cobi.12801](https://doi.org/10.1111/cobi.12801).

42. Martnez-Ramos M, Ortz-Rodrguez I, Pinero D, Dirzo R, Sarukhn J (2016) *Humans disrupt ecological processes within tropical rainforest reserves*. Proc Natl Acad Sci USA **113**:5323-5328.
43. Camargo-Sanabria AA, Mendoza E, Guevara R, Martnez-Ramos M, Dirzo R (2015) *Experimental defaunation of terrestrial mammalian herbivores alters tropical rainforest understorey diversity*. Proc Biol Sci **282**:20142580.
44. Petipas RH, Brody AK (2014) *Termites and ungulates affect arbuscular mycorrhizal richness and infectivity in a semiarid savanna*. Botany **92**:233-240.
45. Wardle DA, et al. (2004) *Ecological linkages between aboveground and belowground biota*. Science **304**:1629-1633.
46. Ceballos G, Ehrlich AH, Ehrlich PR (2015) *The Annihilation of Nature: Human Extinction of Birds and Mammals*, (Johns Hopkins Univ Press, Baltimore).
47. Knoll AH (2015) *Life on a Young Planet: The First Three Billion Years of Evolution on Earth*, (Princeton Univ Press, Princeton, NJ).
48. Barnosky AD, et al. (2014) *Introducing the scientific consensus on maintaining humanity's life support systems in the 21st century: Information for policy makers*. The Anthropocene Review **1**:78-109.
49. Ceballos G, Ehrlich PR, Sobern J, Salazar I, Fay JP (2005) *Global mammal conservation: What must we manage?* Science **309**:603-607.
50. Brown IL, Ehrlich PR (1980) *Population biology of the checkerspot butterfly, Euphydryas chalcedona structure of the Jasper Ridge colony*. Oecologia **47**:239-251.
51. Environmental Systems Research Institute (2011) *Release 10. Documentation Manual*, (Environmental Systems Research Institute, Redlands, CA).
52. Balling, R. C. 1988. *The climate impact of Sonoran vegetation discontinuity*. Climate Change **13**: 99-109.
53. Balling, R. C. 1991. *Impact of desertification on regional and global warming*. Bulletin of the American Meteorological Society **72**: 232-234.
54. Barigozzi, C. (ed.). 1986. *The Origin and Domestication of Cultivated Plants*. Amsterdam: Elsevier.
55. Botkin, D. B. 1989. *Science and the global environment*. In: D. B. Botkin et al., **Global Change**. New York: Academic Press, pp. 1-14.
56. Bryson, R. 1972. *Climate modification by air pollution*. In: N. Polunin (ed.), *The Environmental Future*. London: Macmillan, pp. 133-174.
57. Dregne, H. E., M. Kassas, and B. Rozanov. 1991. *A new assessment of the world status of desertification*. Desertification Control Bulletin, **no. 20**: 6-18.
58. FAO (Food and Agriculture Organization). 1991. *Protection of land resources: Deforestation* UNCED Prepcomm., 2nd session, Doc. A/CONF. 15/PC/27.
59. Hare, F. K. and L. A. J. Ogallo. 1993. *Climate Variation, Drought and Desertification*. WMO-No. 653. Geneva: WMO.
60. Houghton, J. T., B. A. Callander, and S. K. Varney (eds.). 1992. *Climate Change 1992. The Supplementary Report to the IPCC Scientific Assessment*. (Cambridge: Cambridge University Press.

61. Hulme, M. and M. Kelly. 1993. *Exploring the links between desertification and climate change*. Environment **35(6)**: 5-11, 39-45.
62. Jackson, R. D. and S. B. Idso. 1975. *Surface albedo and desertification*. Science **189**: 1012-1013.
63. Matthews, E. 1983. *Global vegetation and land use: New high-resolution databases for climatic studies*. Journal of Climate and Meteorology **22**: 474-487.
64. Schlesinger, W. H., et al. 1990. *Biological feedback in global desertification*. Science **247**: 1043-1048.
65. Turner, B. L., et al. 1990. *Two types of global environmental changes: Definitional and special-scale issues in their human dimensions*. Global Environmental Change 1: 14-22.
66. UNESCO. 1960. *Medicinal plants of arid zones*. Arid Zone Research 13.
67. Vavilov, N. I. 1949. *The Origin, Variation, Immunity and Breeding of Cultivated Plants*. Waltham, Mass.: Chronica Botanical
68. Rachel L. Carson *Under the Sea-Wind* Oxford University Press, 1952
69. Rachel L. Carson *The Sea Around Us* Oxford University Press, 1953
70. Rachel Carson *The Edge of the Sea* Houghton Mifflin, 1955
71. Rachel Carson *Silent Spring* Houghton Mifflin, 1962
72. Linda Lear *Rachel Carson: The Life of the Author of Silent Spring* Penguin Group, 1997
73. William Souder *On a Farther Shore: The Life and Legacy of Rachel Carson* Crown Publishers, 2012

Chapter 8

INTOLERABLE ECONOMIC INEQUALITY

8.1 Shocking statistics

Intolerable and unjust economic inequality is increasing rapidly, both within and between nations. Statistics show that half of the world's net wealth belongs to the top 1%. They own as much as the remaining 99% of the world's peoples, the other 7.4 billion of us.

8.2 Benefits of equality

The Industrial Revolution opened up an enormous gap in military strength between the industrialized nations and the rest of the world. Taking advantage of their superior weaponry, Europe, the United States and Japan rapidly carved up the remainder of the world into colonies, which acted as sources of raw materials and food, and as markets for manufactured goods. Between 1800 and 1914, the percentage of the earth under the domination of colonial powers increased to 85 percent, if former colonies are included.

The English economist and Fabian, John Atkinson Hobson (1858-1940), offered a famous explanation of the colonial era in his book "Imperialism: A Study" (1902). According to Hobson, the basic problem that led to colonial expansion was an excessively unequal distribution of incomes in the industrialized countries. The result of this unequal distribution was that neither the rich nor the poor could buy back the total output of their society. The incomes of the poor were insufficient, and rich were too few in number. The rich had finite needs, and tended to reinvest their money. As Hobson pointed out, reinvestment in new factories only made the situation worse by increasing output.

Hobson had been sent as a reporter by the Manchester Guardian to cover the Second Boer War. His experiences had convinced him that colonial wars have an economic motive. Such wars are fought, he believed, to facilitate investment of the excess money of the rich in African or Asian plantations and mines, and to make possible the overseas sale of excess manufactured goods. Hobson believed imperialism to be immoral, since it entails suffering



Figure 8.1: **World wealth levels in 2004.** Countries with per capita wealth greater than 100,000 USD are shown in red, while those with per capita wealth less than 5,000 USD are shown in blue.

both among colonial peoples and among the poor of the industrial nations. The cure that he recommended was a more equal distribution of incomes in the manufacturing countries.

Interestingly, TED Talks (ideas worth spreading) was recently under fire from many progressive groups for censoring a short talk by the adventure capitalist, Nick Hanauer, entitled “Income Inequality”. In this talk, Hanauer said exactly the same thing as John Hobson, but he applies the ideas, not to colonialism, but to current unemployment in the United States. Hanauer said that the rich are unable to consume the products of society because they are too few in number. To make an economy work, demand must be increased, and for this to happen, the distribution of incomes must become much more equal than it is today in the United States.

TED has now posted Hanauer’s talk, and the interested reader can find another wonderful TED talk dealing with the same issues from the standpoint of health and social problems. In a splendid lecture entitled “How economic inequality harms societies”, Richard Wilkinson demonstrates that there is almost no correlation between gross national product and a number of indicators of the quality of life, such as physical health, mental health, drug abuse, education, imprisonment, obesity, social mobility, trust, violence, teenage pregnancies and child well-being. On the other hand he offers comprehensive statistical evidence that these indicators are strongly correlated with the degree of inequality within countries, the outcomes being uniformly much better in nations where income is more equally distributed.

Warren Buffet famously remarked, “There’s class warfare, all right. But it’s my class, the rich class, that’s making war, and we’re winning.” However, the evidence presented by Hobson, Hanauer and Wilkinson shows conclusively that no one wins in a society where inequality is too great, and everyone wins when incomes are more evenly distributed.



Figure 8.2: In many countries, children live by scavenging from garbage dumps.



Figure 8.3: Even in rich countries, many millions of people live in poverty,

8.3 Extreme inequality today

Here are some quotations from a report by the Global Inequality organization: ¹

Inequality has been on the rise across the globe for several decades. Some countries have reduced the numbers of people living in extreme poverty. But economic gaps have continued to grow as the very richest amass unprecedented levels of wealth. Among industrial nations, the United States is by far the most top-heavy, with much greater shares of national wealth and income going to the richest 1 percent than any other country.

The world's richest 1 percent, those with more than \$1 million, own 45 percent of the world's wealth. Adults with less than \$10,000 in wealth make up 64 percent of the world's population but hold less than 2 percent of global wealth. The world's wealthiest individuals, those owning over \$100,000 in assets, total less than 10 percent of the global population but own 84 percent of global wealth. Credit Suisse defines "wealth" as the value of a household's financial assets plus real assets (principally housing), minus their debts.

"Ultra high net worth individuals" - the wealth management industry's term for people worth more than \$30 million - hold an astoundingly disproportionate share of global wealth. These wealth owners hold 11.3 percent of total global wealth, yet represent only a tiny fraction (0.003%) of the world population.

The world's 10 richest billionaires, according to Forbes, own \$745 billion in combined wealth, a sum greater than the total goods and services most nations produce on an annual basis. The globe is home to 2,208 billionaires, according to the 2018 Forbes ranking.

Those with extreme wealth have often accumulated their fortunes on the backs of people around the world who work for poor wages and under dangerous conditions. According to Oxfam, the wealth divide between the global billionaires and the bottom half of humanity is steadily growing. Between 2009 and 2017, the number of billionaires it took to equal the wealth of the world's poorest 50 percent fell from 380 to 42...

The United States has more wealth than any other nation. But America's top-heavy distribution of wealth leaves typical American adults with far less wealth than their counterparts in other industrial nations.

8.4 Oligarchy replaces democracy in many countries

The jaws of power

"Every government degenerates when trusted to the rulers of the people alone. The people themselves, therefore, are its only safe depositories." Thomas Jeffer-

¹<https://inequality.org/facts/global-inequality/>

son, (1743-1826)

“The jaws of power are always open to devour, and her arm is always stretched out, if possible, to destroy the freedom of thinking, speaking, and writing.”
John Adams, (1735-1826)

According to the Nuremberg Principles, the citizens of a country have a responsibility for the crimes that their governments commit. But to prevent these crimes, the people need to have some knowledge of what is going on. Indeed, democracy cannot function at all without this knowledge.

What are we to think when governments make every effort to keep their actions secret from their own citizens? We can only conclude that although they may call themselves democracies, such governments are in fact oligarchies or dictatorships.

At the end of World War I, it was realized that secret treaties had been responsible for its outbreak, and an effort was made to ensure that diplomacy would be more open in the future. Needless to say, these efforts did not succeed, and diplomacy has remained a realm of secrecy.

Many governments have agencies for performing undercover operations (usually very dirty ones). We can think, for example of the KGB, the CIA, M5, or Mossad. How can countries that have such agencies claim to be democracies, when the voters have no knowledge of or influence over the acts that are committed by the secret agencies of their governments?

Nuclear weapons were developed in secret. It is doubtful whether the people of the United States would have approved of the development of such antihuman weapons, or their use against an already-defeated Japan, if they had known that these things were going to happen. The true motive for the nuclear bombings was also kept secret. In the words of General Groves, speaking confidentially to colleagues at Los Alamos, the real motive was “to control the Soviet Union”.

The true circumstances surrounding the start of the Vietnam war would never have been known if Daniel Ellsberg had not leaked the Pentagon Papers. Ellsberg thought that once the American public realized that their country’s entry into the war was based on a lie, the war would end. It did not end immediately, but undoubtedly Ellsberg’s action contributed to the end of the war.

We do not know what will happen to Julian Assange. If his captors send him to the US, and if he is executed there for the crime of publishing leaked documents (a crime that he shares with the New York Times), he will not be the first martyr to the truth. The ageing Galileo was threatened with torture and forced to recant his heresy - that the earth moves around the sun. Galileo spent the remainder of his days in house arrest. Giordano Bruno was less lucky. He was burned at the stake for maintaining that the universe is larger than it was then believed to be. If Julian Assange becomes a martyr to the truth like Galileo or Bruno, his name will be honored by generations in the future, and the shame of his captors will be remembered too.

The deep state

Can a government, many of whose operations are secret, be a democracy? Obviously this is impossible. The recent attempts of the United States to arrest whistleblower Edward Snowden call attention to the glaring contradiction between secrecy and democracy.

In a democracy, the power of judging and controlling governmental policy is supposed to be in the hands of the people. It is completely clear that if the people do not know what their government is doing, then they cannot judge or control governmental policy, and democracy has been abolished. There has always been a glaring contradiction between democracy and secret branches of the government, such as the CIA, which conducts its assassinations and its dirty wars in South America without any public knowledge or control.

The gross, wholesale electronic spying on citizens revealed by Snowden seems to be specifically aimed at eliminating democracy. It is aimed at instilling universal fear and conformity, fear of blackmail and fear of being out of step, so that the public will not dare to oppose whatever the government does, no matter how criminal or unconstitutional.

Henry Kissinger famously remarked: “The illegal we do at once. The unconstitutional takes a little longer”. Well, Henry, that may have been true in your time, but today the unconstitutional does not take long at all.

The Magna Carta is trashed. No one dares to speak up. Habeas Corpus is trashed. No one dares to speak up. The United Nations Charter is trashed. No one dares to speak up. The Universal Declaration of Human Rights is trashed. No one dares to speak up. The Fourth Amendment to the US Constitution is trashed. No one dares to speak up. The President claims the right to kill both US and foreign citizens, at his own whim. No one dares to speak up.

But perhaps this is unjust. Perhaps some people would dare to protest, except that they cannot get their protests published in the mainstream media. We must remember that the media are owned by the same corporate oligarchs who own the government.

George Orwell, you should be living today! We need your voice today! After Snowden’s revelations, the sale of Orwell’s “1984” soared. It is now on the bestseller list. Sadly, Orwell’s dystopian prophesy has proved to be accurate in every detail.

What is the excuse for for the massive spying reported by Snowden, spying not only on US citizens but also on the citizens of other countries throughout the world? “We want to protect you from terrorism.”, the government answers. But terrorism is not a real threat, it is an invented one. It was invented by the military-industrial complex because, at the end of the Cold War, this enormous money-making conglomerate lacked enemies.

Globally, the number of people killed by terrorism is vanishingly small compared to the number of children who die from starvation every year. It is even vanishingly small compared with the number of people who are killed in automobile accidents. It is certainly small compared with the number of people killed in wars aimed at gaining western hegemony over oil-rich regions of the world.

But in Shelley’s words, “We are many; they are few!” The people who want democracy greatly outnumber those who profit from maintaining a government based on secrecy and fear. Let us “rise like lions after slumbers, in unvanquishable numbers”. Let us abolish

governmental secrecy and reclaim our democracy.

8.5 Media in the service of powerholders

Throughout history, art was commissioned by rulers to communicate, and exaggerate, their power, glory, absolute rightness etc, to the populace. The pyramids gave visual support to the power of the Pharaoh; portraits of rulers are a traditional form of propaganda supporting monarchies; and palaces were built as symbols of power.

Modern powerholders are also aware of the importance of propaganda. Thus the media are a battleground where reformers struggle for attention, but are defeated with great regularity by the wealth and power of the establishment. This is a tragedy because today there is an urgent need to make public opinion aware of the serious problems facing civilization, and the steps that are needed to solve these problems. The mass media could potentially be a great force for public education, but often their role is not only unhelpful - it is negative.

It is certainly possible to find a few television programs and newspaper articles that present the facts about climate change in a realistic way. For example *The Guardian* gives outstanding climate change coverage. However, the mass media could do very much more. One has to conclude that the media are neglecting their great responsibilities at a time of acute crisis for human civilization and the biosphere. The same can be said of our educational systems at both both the primary and advanced levels. We urgently need much more public education about the severe dangers that we face today.

8.6 Television as a part of our educational system

In the mid-1950's, television became cheap enough so that ordinary people in the industrialized countries could afford to own sets. During the infancy of television, its power was underestimated. The great power of television is due to the fact that it grips two senses simultaneously, both vision and hearing. The viewer becomes an almost-hypnotized captive of the broadcast.

In the 1950's, this enormous power, which can be used both for good and for ill, was not yet fully apparent. Thus insufficient attention was given to the role of television in education, in setting norms, and in establishing values. Television was not seen as an integral part of the total educational system. It is interesting to compare the educational systems of traditional cultures with those of modern industrial societies.

In traditional societies, multigenerational families often live together in the same dwelling. In general, there is a great deal of contact between grandparents and grandchildren, with much transmission of values and norms between generations. Old people are regarded with great respect, since they are considered to be repositories of wisdom, knowledge, and culture.

By contrast, modern societies usually favor nuclear families, consisting of only parents

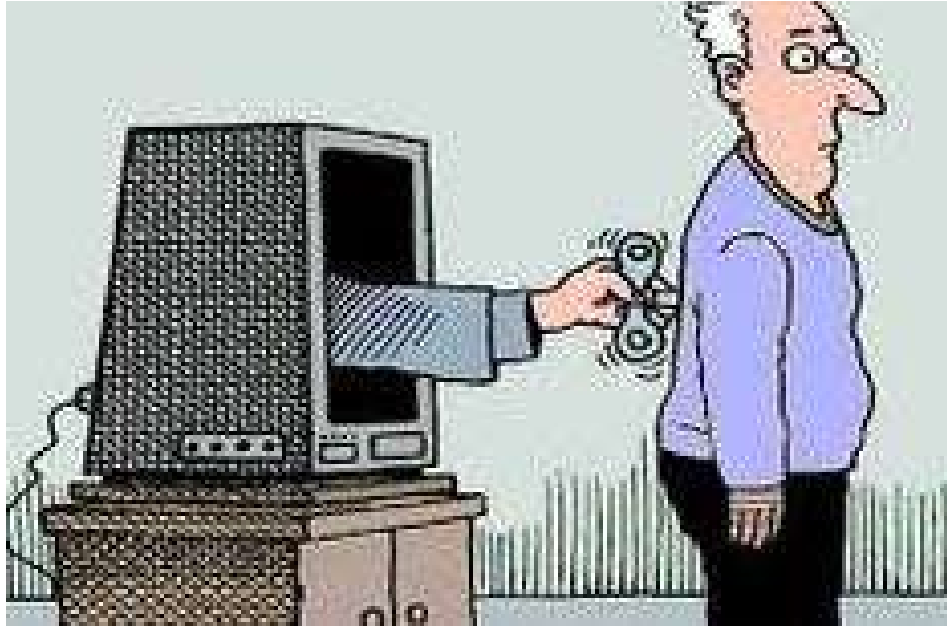

Figure 8.4: **The role of the media.**



Figure 8.5: **Liberty?**

and children. Old people are marginalized. They live by themselves in communities or homes especially for the old. Their cultural education knowledge and norms are not valued because they are “out of date”. In fact, during the life of a young person in one of the rapidly-changing industrial societies of the modern world, there is often a period when they rebel against the authority of their parents and are acutely embarrassed by their parents, who are “so old-fashioned that they don’t understand anything”.

Although the intergenerational transmission of values, norms, and culture is much less important in industrial societies than it is in traditional ones, modern young people of the West and North are by no means at a loss over where to find their values, fashions and role models. With every breath, they inhale the values and norms of the mass media. Totally surrounded by a world of television and film images, they accept this world as their own.

8.7 Neglect of climate change in the mass media

The predicament of humanity today has been called “a race between education and catastrophe”: How do the media fulfil this life-or-death responsibility? Do they give us insight? No, they give us pop music. Do they give us an understanding of the sweep of evolution and history? No, they give us sport. Do they give us an understanding of the ecological catastrophes that threaten our planet because of unrestricted growth of population and industries? No, they give us sit-coms and soap operas. Do they give us unbiased news? No, they give us news that has been edited to conform with the interests of powerful lobbies. Do they present us with the urgent need to leave fossil fuels in the ground? No, they do not, because this would offend the powerholders. Do they tell of the danger of passing tipping points after which human efforts to prevent catastrophic climate change will be useless? No, they give us programs about gardening and making food.

A consumer who subscribes to the “package” of broadcasts sold by a cable company can often search through all 95 channels without finding a single program that offers insight into the various problems that are facing the world today. What the viewer finds instead is a mixture of pro-establishment propaganda and entertainment. Meanwhile the neglected global problems are becoming progressively more severe.

In general, the mass media behave as though their role is to prevent the peoples of the world from joining hands and working to change the world and to save it from thermonuclear war, environmental catastrophes and threatened global famine. The television viewer sits slumped in a chair, passive, isolated, disempowered and stupefied. The future of the world hangs in the balance, the fate of children and grandchildren hangs in the balance, but the television viewer feels no impulse to work actively to change the world or to save it. The Roman emperors gave their people bread and circuses to numb them into political inactivity. The modern mass media seem to be playing a similar role.



Figure 8.6: Network administrators have noticed that programs about climate change often have low viewer ratings. Since they see delivering high viewer ratings to their advertisers as their primary duty, these executives seldom allow programs dealing with the danger of catastrophic climate change. The duty to save the earth from environmental catastrophe is neglected for the sake of money. As Al Gore said, “Instead of having a well-informed electorate, we have a well-amused audience”.

8.8 Climate change denial in mass media

The Wikipedia article on climate change denial describes it with the following words: “Although scientific opinion on climate change is that human activity is extremely likely to be the primary driver of climate change, the politics of global warming have been affected by climate change denial, hindering efforts to prevent climate change and adapt to the warming climate. Those promoting denial commonly use rhetorical tactics to give the appearance of a scientific controversy where there is none.”

It is not surprising that the fossil fuel industry supports, on a vast scale, politicians and mass media that deny the reality of climate change. The amounts of money at stake are vast. If catastrophic climate change is to be avoided, coal, oil and natural gas “assets” worth trillions of dollars must be left in the ground. Giant fossil fuel corporations are desperately attempting to turn these “assets’ into cash.



Preventing an ecological apocalypse

Here are some excerpts from an article entitled “**Only Rebellion will prevent an ecological apocalypse**” by George Monbiot, which was published on April 15 2019 in *The Guardian*²:

No one is coming to save us. Mass civil disobedience is essential to force a political response.

Had we put as much effort into preventing environmental catastrophe as we’ve spent on making excuses for inaction, we would have solved it by now. Everywhere I look, I see people engaged in furious attempts to fend off the moral challenge it presents...

As the environmental crisis accelerates, and as protest movements like YouthStrike4Climate and Extinction Rebellion make it harder not to see what we face, people discover more inventive means of shutting their eyes and shedding responsibility. Underlying these excuses is a deep-rooted belief that if we really are in trouble, someone somewhere will come to our rescue: “they” won’t let it happen. But there is no they, just us.

The political class, as anyone who has followed its progress over the past three years can surely now see, is chaotic, unwilling and, in isolation, strategically incapable of addressing even short-term crises, let alone a vast existential predicament. Yet a widespread and wilful naivety prevails: the belief that voting is the only political action required to change a system. Unless it is accompanied by the concentrated power of protest - articulating precise de-

²<https://www.theguardian.com/commentisfree/2019/apr/15/rebellion-prevent-ecological-apocalypse-civil-disobedience>

mands and creating space in which new political factions can grow - voting, while essential, remains a blunt and feeble instrument.

The media, with a few exceptions, is actively hostile. Even when broadcasters cover these issues, they carefully avoid any mention of power, talking about environmental collapse as if it is driven by mysterious, passive forces, and proposing microscopic fixes for vast structural problems. The BBC's Blue Planet Live series exemplified this tendency.

Those who govern the nation and shape public discourse cannot be trusted with the preservation of life on Earth. There is no benign authority preserving us from harm. No one is coming to save us. None of us can justifiably avoid the call to come together to save ourselves...

Predatory delay

Here are some excerpts from a May 3 2019 article by Bill Henderson entitled "Neoliberalism, Solution Aversion, Implicatory Denial and Predatory Delay"³:

Looking back at the history, that it's not really a failure of human beings and human nature that's the problem here. It's a hijacking of our political and economic system by the fossil fuel industry and a small number of like-minded people. It was our bad luck that this idea that markets solve all problems and that government should be left to wither away crested just at the moment when it could do the most damage.

Despite the urgent need to reduce greenhouse gas emissions globally if we are to lower the risks of catastrophic climate change, wealthy industrialized nations persist with a widespread public silence on the issue and fail to address climate change. This is despite there being ever more conclusive evidence of its severity. Why is there an undercurrent of inaction, despite the challenge of climate change being ever more daunting? One element is denial.

George Marshall discovered that there has not been a single proposal, debate or even position paper on limiting fossil fuel production put forward during international climate negotiations. From the very outset fossil fuel production lay outside the frame of the discussions and, as with other forms of socially constructed silence, the social norms among the negotiators and policy specialists kept it that way.

Global climate leadership is being redefined. There is a growing recognition that you cannot be a climate leader if you continue to enable new fossil fuel production, which is inconsistent with climate limits. If no major producers step up to stop the expansion of extraction and begin phasing out existing fields and mines, the Paris goals will become increasingly difficult to achieve.

³<https://countercurrents.org/2019/05/03/neoliberalism-solution-aversion-implicatory-denial-and-predatory-delay-bill-henderson/>

Wealthy fossil fuel producers have a responsibility to lead, and this must include planning for a just and equitable managed decline of existing production.

The (emissions reduction) curve we've been forced onto bends so steeply, that the pace of victory is part of victory itself. Winning slowly is basically the same thing as losing outright. We cannot afford to pursue past strategies, aimed at limited gains towards distant goals. In the face of both triumphant denialism and predatory delay, trying to achieve climate action by doing the same things, the same old ways, means defeat. It guarantees defeat.

A fast, emergency-scale transition to a post-fossil fuel world is absolutely necessary to address climate change. But this is excluded from consideration by policymakers because it is considered to be too disruptive. The orthodoxy is that there is time for an orderly economic transition within the current short-termist political paradigm. Discussion of what would be safe - less warming than we presently experience - is non-existent. And so we have a policy failure of epic proportions. Policymakers, in their magical thinking, imagine a mitigation path of gradual change, to be constructed over many decades in a growing, prosperous world...

8.9 Showing unsustainable lifestyles in mass media

Television and other mass media contribute indirectly to climate change denial by showing unsustainable lifestyles. Television dramas show the ubiquitous use of gasoline-powered automobiles and highways crowded with them. just as though there did not exist an urgent need to transform our transportation systems. Motor racing is shown. A program called "Top Gear" tells viewers about the desirability of various automobiles. In general, cyclists are not shown. In television dramas, the protagonists fly to various parts of the world for their holidays. The need for small local self-sustaining communities is not shown.

Advertisements in the mass media urge us to consume more, to fly, to purchase large houses, and to buy gasoline-driven automobiles, just as though such behavior ought to be the norm. Such norms are leading us towards environmental disaster.

8.10 Alternative media

Luckily, the mass media do not have a complete monopoly on public information. With a little effort, citizens who are concerned about the future can find alternative media. These include a large number of independent on-line news services that are supported by subscriber donations rather than by corporate sponsors. *YouTube* videos also represent an extremely important source of public information.



8.11 Outstanding voices calling for climate action

The Guardian

There are exceptions to the general rule that the mass media downplay or completely ignore the climate emergency. The Guardian is a newspaper with absolutely outstanding coverage of all issues related to climate change. No praise can be strong enough for the courageous environmental editorial policy of this famous old British newspaper.

Al Gore

Albert Arnold Gore Jr. served as the 45th Vice President of the United States from January 1985 to January 1993. He then ran for the office of President, but was defeated by George W. Bush in a controversial election whose outcome was finally decided by the US Supreme Court⁴.

Al Gore is the founder and current Chairman of the Alliance for Climate Protection. He was one of the first important political figures to call attention to the problem of steadily increasing CO₂ levels in the atmosphere and the threat of catastrophic climate change. He produced the highly influential documentary film *An Inconvenient Truth*⁵. Because of his important efforts to save the global environment, Al Gore shared the 2007 Nobel Peace Prize with the Intergovernmental Panel on Climate Change.

⁴Many people believe that Al Gore won the election.

⁵<https://www.youtube.com/watch?v=I-SV13UQXdk>

Al Gore's TED talk: The Case for Optimism on Climate Change

In 2016, Al Gore gave an important talk to a TED audience⁶. in which he pointed out the an economic tipping point has just been passed. Solar energy and wind energy are now cheaper than energy form fossil fuels. This means that economic forces alone can drive a rapid transition to 100% renewable energy. Investors will realize that renewables represent an unparalleled investment opportunity.

Sir David Attenborough

In a 2011 interview in The Guardian, Sir David Attenborough was asked: “What will it take to wake people up about climate change?”. He replied “Disaster. It’s a terrible thing to say, isn’t it? And even disaster doesn’t always do it. I mean, goodness me, there have been disasters in North America, with hurricanes, and one thing and another, and floods; and still a lot of people would deny it, and say it’s nothing to do with climate change. Well it visibly has to do with climate change!”

Sir David Attenborough’s almost unbelievably enormous and impressive opus of television programs about the natural world have helped to raise public awareness of the importance of the natural environment. He also has made a number of television programs specifically related to questions such as saving threatened species, the dangers of exploding global human populations, and the destruction of forests for the sake of palm oil plantations.

Let us return to The Guardian’s 2011 interview with Sir David. Had it been made in the autumn of 2017, the interview would certainly have included a discussion of recent hurricanes of unprecedented power and destructiveness, such as Harvey, Irma and Maria, as well as 2017’s wildfires and Asian floods. It is possible that such events, which will certainly become more frequent and severe during the next few years, will provide the political will needed to silence climate change denial, to stop fossil fuel extraction, and to promote governmental policies favoring renewable energy.

Although the mass media almost have entirely neglected the link between climate change and recent disastrous hurricanes, floods droughts and wildfires, many individuals and organizations emphasized the cause and effect relationship. For example, UK airline billionaire Sir Richard Branson, whose Caribbean summer residence was destroyed by Hurricane Irma said:

“Look, you can never be 100 percent sure about links, But scientists have said the storms are going to get more and more and more intense and more and more often. We’ve had four storms within a month, all far greater than that have ever, ever, ever happened in history, Sadly, I think this is the start of things to come. Climate change is real. Ninety-nine percent of scientists know it’s real. The whole world knows it’s real except for maybe one person in the White House.”

May Boeve, executive director of the NGO 350.org, said “With a few exceptions, the major TV networks completely failed to cover the scientifically proven ways that climate

⁶<https://www.youtube.com/watch?v=I-SV13UQXdk>

change is intensifying extreme weather events like hurricanes Harvey and Irma. That's not just disappointing, it's dangerous. We won't be able to turn this crisis around if our media is asleep at the wheel."

Commenting on the destruction of Puerto Rico by Hurricane Maria, historian Juan Cole wrote: "When you vote for denialist politicians, you are selecting people who make policy. The policy they make will be clueless and will actively endanger the public. Climate change is real. We are causing it by our emissions. If you don't believe that, you are not a responsible steward of our infrastructure and of our lives."

When interviewed by Amy Goodman of *Democracy Now*, musician Stevie Wonder said: "... we should begin to love and value our planet, and anyone who believes that there is no such thing as global warming must be blind or unintelligent."

Another well-known musician, Beyoncé, added: "The effects of climate change are playing out around the world every day. Just this past week, we've seen devastation from the monsoon in India...and multiple catastrophic hurricanes. Irma alone has left a trail of death and destruction from the Caribbean to Florida to Southern United States. We have to be prepared for what comes next..."

In her September 2017 publication *Season of Smoke*⁷, prizewinning author Naomi Klein wrote:

"We hear about the record-setting amounts of water that Hurricane Harvey dumped on Houston and other Gulf cities and towns, mixing with petrochemicals to pollute and poison on an unfathomable scale. We hear too about the epic floods that have displaced hundreds of thousands of people from Bangladesh to Nigeria (though we don't hear enough). And we are witnessing, yet again, the fearsome force of water and wind as Hurricane Irma, one of the most powerful storms ever recorded, leaves devastation behind in the Caribbean, with Florida now in its sights.

"Yet for large parts of North America, Europe, and Africa, this summer has not been about water at all. In fact it has been about its absence; it's been about land so dry and heat so oppressive that forested mountains exploded into smoke like volcanoes. It's been about fires fierce enough to jump the Columbia River; fast enough to light up the outskirts of Los Angeles like an invading army; and pervasive enough to threaten natural treasures, like the tallest and most ancient sequoia trees and Glacier National Park.

"For millions of people from California to Greenland, Oregon to Portugal, British Columbia to Montana, Siberia to South Africa, the summer of 2017 has been the summer of fire. And more than anything else, it's been the summer of ubiquitous, inescapable smoke.

"For years, climate scientists have warned us that a warming world is an extreme world, in which humanity is buffeted by both brutalizing excesses and stifling absences of the core elements that have kept fragile life in equilibrium for millennia. At the end of the summer of 2017, with major cities submerged in water and others licked by flames, we are currently living through Exhibit A of this extreme world, one in which natural extremes

⁷<https://theintercept.com/2017/09/09/in-a-summer-of-wildfires-and-hurricanes-my-son-asks-why-is-everything-going-wrong/>



Figure 8.7: Sir David Attenborough: “Disaster. It’s a terrible thing to say, isn’t it?”

come head-to-head with social, racial, and economic ones.”

It seems likely that the climate-linked disasters of 2019 and 2020 will be even more severe than those that we have witnessed during 2017 and 2018. But will such disasters be enough to wake us up?

The BBC has recently announced that Sir David Attenborough is currently producing a new series, *Blue Planet II*, which will focus on environmental issues.⁸

“My hope is that the world is coming to its senses ... I’m so old I remember a time when ... we didn’t talk about climate change, we talked about animals and species extermination,” Sir David told Greenpeace in an interview, “For the first time I’m beginning to think there is actually a groundswell, there is a change in the public view. I feel many more people are concerned and more aware of what the problems are. Young people - people who’ve got 50 years of their life ahead of them - they are thinking they ought to be doing something about this. That’s a huge change.”

Climate Change, The Facts

Now Sir David Attenborough has completed a new one-hour BBC program on the danger of catastrophic climate change. Here are some excerpts from an April 18 2019 review of the program by Rebecca Nicholson in *The Guardian*:

The Facts is a rousing call to arms. It is an alarm clock set at a horrifying volume. The first 40 minutes are given over to what Attenborough calls, without hyperbole, “our greatest threat in thousands of years”. Expert af-

⁸<http://www.bbcearth.com/blueplanet2/>



Figure 8.8: Speaking at the opening ceremony of COP24, the universally loved and respected naturalist Sir David Attenborough said: “If we don’t take action, the collapse of our civilizations and the extinction of much of the natural world is on the horizon.”

ter expert explains the consequences of rising CO₂ levels, on the ice caps, on coastal regions, on weather and wildlife and society itself. The most powerful moments are in footage shot not by expert crews who have spent years on location, but on shaky cameras, capturing the very moment at which the reality of our warming planet struck the person holding the phone. In Cairns, Australia, flying foxes are unable to survive the extreme temperatures; rescuers survey the terrible massacre, and we learn that while 350 were saved, 11,000 died. A man and his son talk through their escape from raging wildfires, over the film they took while attempting to drive through a cavern of blazing red trees. These are horror movies playing out in miniature. It is difficult to watch even five minutes of this and remain somehow neutral, or unconvinced.

Yet as I kept on, scribbling down an increasingly grim list of statistics, most of which I knew, vaguely, though compiled like this they finally sound as dreadful as they truly are - 20 of the warmest years on record happened in the last 22 years; Greenland’s ice sheet is melting five times faster than it was 25 years ago - I started to wonder about responsibility, and if and where it would be placed. This would be a toothless film, in the end, if it were hamstrung by political neutrality, and if its inevitable “it’s not too late” message rested solely on individuals and what relatively little tweaks we might make as consumers. What about corporations? What about governments?

Then, at that exact moment, having played the despair through to its crescendo, the experts served up unvarnished honesty. They lined up to lay out the facts, plain and simple. Fossil fuel companies are the most profitable businesses man has ever known, and they engage in PR offensives, using the same consultants as tobacco companies, and the resulting uncertainty and denial, designed to safeguard profits, has narrowed our window for action. It is unforgivable. I find it hard to believe that anyone, regardless of political affiliation, can watch footage of Trump calling climate change “a hoax ... a money-making industry” and not be left winded by such staggering ignorance or astonishing deceit, though it is, more likely, more bleakly, a catastrophic combination of the two. At least Nigel Lawson only appears here in archive footage, and his argument sounds limp, to put it kindly.

Climate Change: The Facts should not have to change minds, but perhaps it will change them anyway, or at least make this seem as pressing as it needs to be. With the Extinction Rebellion protests across London this week, disrupting day-to-day business, and this, on primetime BBC One, maybe the message will filter through. At the very least, it should incite indignation that more was not done, sooner, and then urgency and a decision to both change and push for change at a much higher level. Because there is, for a brief moment, just possibly, still time.

Greta Thunberg meets Pope Francis

On 19 April 2019, Greta Thunberg met briefly with Pope Francis at the end of his general audience. “Continue, continue!” the Pope told her, “Go on, go ahead!” Greta answered Pope Francis with the words: “Thank you for standing up for the climate, for speaking the truth. It means a lot.” Greta’s father, Svante Thunberg, expressed his gratitude to the pope: “Thank you so much for what you are doing. It means everything. Everything.”

The Pope has made fighting climate change and caring for God’s creation a pillar of his papacy. He wrote an entire encyclical about it, blaming a thirst for money for turning the Earth into a wasteland and demanding immediate action to curb global warming.

While in Rome, Greta Thunberg will also address the Italian Parliament and participate in a school strike for action to avoid catastrophic climate change.

In June, 2015, His Holiness Pope Francis I addressed the climate crisis in an encyclical entitled “Laudato Si’ ”⁹. Here are a few excerpts from this enormously important encyclical, which is addressed not only to the world’s 1.2 billion Catholics, but also to concerned people of all faiths. After reviewing the contributions of his predecessors. Pope Francis makes the following points:

23. The climate is a common good, belonging to all and meant for all. At the global level, it is a complex system linked to many of the essential conditions

⁹<https://unfccc.int/news/pope-francis-releases-encyclical-on-climate-and-environment>

for human life. A very solid scientific consensus indicates that we are presently witnessing a disturbing warming of the climatic system. In recent decades this warming has been accompanied by a constant rise in the sea level and, it would appear, by an increase of extreme weather events, even if a scientifically determinable cause cannot be assigned to each particular phenomenon. Humanity is called to recognize the need for changes of lifestyle, production and consumption, in order to combat this warming or at least the human causes which produce or aggravate it. It is true that there are other factors (such as volcanic activity, variations in the earth's orbit and axis, the solar cycle), yet a number of scientific studies indicate that most global warming in recent decades is due to the great concentration of greenhouse gases (carbon dioxide, methane, nitrogen oxides and others) released mainly as a result of human activity. As these gases build up in the atmosphere, they hamper the escape of heat produced by sunlight at the earth's surface. The problem is aggravated by a model of development based on the intensive use of fossil fuels, which is at the heart of the worldwide energy system. Another determining factor has been an increase in changed uses of the soil, principally deforestation for agricultural purposes.

24. Warming has effects on the carbon cycle. It creates a vicious circle which aggravates the situation even more, affecting the availability of essential resources like drinking water, energy and agricultural production in warmer regions, and leading to the extinction of part of the planet's biodiversity. The melting in the polar ice caps and in high altitude plains can lead to the dangerous release of methane gas, while the decomposition of frozen organic material can further increase the emission of carbon dioxide. Things are made worse by the loss of tropical forests which would otherwise help to mitigate climate change. Carbon dioxide pollution increases the acidification of the oceans and compromises the marine food chain. If present trends continue, this century may well witness extraordinary climate change and an unprecedented destruction of ecosystems, with serious consequences for all of us. A rise in the sea level, for example, can create extremely serious situations, if we consider that a quarter of the world's population lives on the coast or nearby, and that the majority of our megacities are situated in coastal areas.

25. Climate change is a global problem with grave implications: environmental, social, economic, political and for the distribution of goods. It represents one of the principal challenges facing humanity in our day. Its worst impact will probably be felt by developing countries in coming decades. Many of the poor live in areas particularly affected by phenomena related to warming, and their means of subsistence are largely dependent on natural reserves and ecosystemic services such as agriculture, fishing and forestry. They have no other financial activities or resources which can enable them to adapt to climate change or to



Figure 8.9: Greta Thunberg had the privilege of meeting Pope Francis. Both are outstanding voices for climate action.

face natural disasters, and their access to social services and protection is very limited. For example, changes in climate, to which animals and plants cannot adapt, lead them to migrate; this in turn affects the livelihood of the poor, who are then forced to leave their homes, with great uncertainty for their future and that of their children. There has been a tragic rise in the number of migrants seeking to flee from the growing poverty caused by environmental degradation. They are not recognized by international conventions as refugees; they bear the loss of the lives they have left behind, without enjoying any legal protection whatsoever. Sadly, there is widespread indifference to such suffering, which is even now taking place throughout our world. Our lack of response to these tragedies involving our brothers and sisters points to the loss of that sense of responsibility for our fellow men and women upon which all civil society is founded.

At a London event arranged by The Guardian, Greta Thunberg was asked whether she believed that a general strike could alert politicians to the urgency of the climate emergency. She replied “yes”. Here are some of her other comments:



Figure 8.10: Of the fossil fuels, all are bad, but coal is the worst.



Figure 8.11: Speaking to a crowd of many thousands at Marble Arch, London, on April 21, 2019, Greta Thunberg said: “For way too long the politicians and the people in power have gotten away with not doing anything ... But we will make sure that they will not get away with it any longer, We will never stop fighting, we will never stop fighting for this planet, for ourselves, our futures and for the futures of our children and grandchildren.”

This is not just young people being sick of politicians. It's an existential crisis. It is something that will affect the future of our civilization. It's not just a movement. It's a crisis and we must take action accordingly.

At a later meeting with members of the U.K. Parliament, Greta Thunberg said:

The U.K.'s active current support of new exploitation of fossil fuels, like for example the U.K. shale gas fracking industry, the expansion of its North Sea oil and gas fields, the expansion of airports, as well as the planning permission for a brand new coalmine, is beyond absurd.

This ongoing irresponsible behavior will no doubt be remembered in history as one of the greatest failures of humankind. .

Leonardo DiCaprio

Leonardo DiCaprio has won many awards for his work as an actor, writer and producer in both television and films. These include 50 awards from 167 nominations. DiCaprio has been nominated for six Academy Awards, four British Academy Film Awards and nine Screen Actors Guild Awards, winning one award each from them and three Golden Globe Awards from eleven nominations.

In accepting his Best Actor award at the 2016 Oscars ceremony, DiCaprio said: "Climate change is real, it is happening right now. It is the most urgent threat facing our entire species, and we need to work collectively together and stop procrastinating. We need to support leaders around the world who do not speak for the big polluters, but who speak for all of humanity, for the indigenous people of the world, for the billions and billions of underprivileged people out there who would be most affected by this. For our children's children, and for those people out there whose voices have been drowned out by the politics of greed."

Leonardo DiCaprio has used his great success as an actor in the service of environmental causes. In 1997, following the box office success of *Titanic*, he set up the Leonardo DiCaprio Foundation, which is devoted to environmental causes. He chaired the national Earth Day celebrations in 2000 during which he interviewed US President Bill Clinton, with whom he discussed the actions needed to avoid catastrophic climate change. In 2007 he had a major role in *The 11th Hour*, a documentary about people's relationship to nature and global warming. He also co-produced and co-wrote the film.

DiCaprio's most influential film on climate change is *Before the Flood*¹⁰. This film, released in 2016, is a 1 hour and 36 minute documentary in which Leonardo DiCaprio travels to many countries to let viewers observe the already visible effects of global warming. He also talks with many of the world's leaders, including Pope Francis I, US Presidents Bill Clinton and Barack Obama, and UN Secretary General Ban Ki-moon.

¹⁰<http://www.get.filmovie.us/play.php?movie=tt5929776t>



Figure 8.12: Leonardo DiCaprio at a press conference in 2000 (Wikipedia).



Figure 8.13: Thom Hartmann speaks to the 2010 Chicago Green Festival (Wikipedia).

Thom Hartmann

Thom Hartmann was born in 1951 in Lansing Michigan. He worked as a disk jockey during his teens, and, after a highly successful business career, he sold his businesses and devoted his energies to writing, humanitarian projects and public education. His influential book, *Last Hours of Ancient Sunlight* was published by Three Rivers Press in 1997 and republished in a revised edition in 2004. In 2013, Hartmann published another extremely important book on the same theme: *The Last Hours of Humanity: Warming the World To Extinction*¹¹.

Hartmann has hosted a nationally syndicated radio show, The Thom Hartmann Program, since 2003 and a nightly television show, The Big Picture, since 2008.

Concerning Hartmann’s radio show, Wikipedia states that “As of March 2016, the show was carried on 80 terrestrial radio stations in 37 states as well as on Sirius and XM satellite radio. A community radio station in Africa, Radio Builsa in Ghana, also broadcasts the show. Various local cable TV networks simulcast the program. In addition to Westwood One, the show is now also offered via Pacifica Audioport to non-profit stations in a non-profit compliant format and is simulcast on Dish Network channel 9415 and DirecTV channel 348 via Free Speech TV. The program is carried on Radio Sputnik in London, England.”

“Sen. Bernie Sanders (I-VT) appears every Friday during the first hour of the show titled ‘Brunch with Bernie’. Ellen Ratner of the Talk Radio News Service provides Washington commentary daily. Victoria Jones who is the White House correspondent for Talk

¹¹<https://www.amazon.com/Last-Hours-Humanity-Warming-Extinction/dp/1629213640>

Radio News Service appears occasionally as does Dr. Ravi Batra an economics professor at SMU.”

Together with Leonardo DiCaprio, Thom Hartman recently produced and narrated an extremely important short film entitled *Last Hours*¹². This film, draws a parallel between the Permian-Triassic mass extinction, and the danger of a human-induced 6th mass extinction. Various experts who appear in the film confirm that our release of CO₂ into the atmosphere is similar to the greenhouse gasses produced by volcanic eruptions prior to the Permian event. The methane hydrate feedback loop is also discussed. The film should be seen by everyone concerned with the future of human civilization and the biosphere. Concerned citizens should also urgently see Hartman and DiCaprio’s short films *Carbon*, *Green World Rising* and *Reforestation*, also available on YouTube .

James Hansen

James Hansen was born in 1941 in Denison, Iowa. He was educated in physics, mathematics and astronomy at the University of Iowa in the space sciences program initiated James Van Allen. He graduated with great distinction. The studies of the atmosphere and temperature of Venus which Hansen made under Van Allen’s supervision lead him to become extremely concerned about similar effects in the earth’s atmosphere.

From 1962 to 1966, James Hansen participated in the National Aeronautical and Space Administration graduate traineeship and, at the same time, between 1965 and 1966, he was a visiting student at the Institute of Astrophysics at the University of Kyoto and in the Department of Astronomy at the University of Tokyo. Hansen then began work at the Goddard Institute for Space Studies in 1967. He began to work for the Goddard Institute for Space Studies in 1967. Between 1981 and 2013, he was head of the Goddard Institute of Space Studies in New York, and since 2014, he has been the director of the Program on Climate Science, Awareness and Solutions at Columbia University’s Earth Institute.

Hansen continued his work with radiative transfer models, attempting to understand the Venusian atmosphere. Later he applied and refined these models to understand the Earth’s atmosphere, in particular, the effects that aerosols and trace gases have on Earth’s climate. Hansen’s development and use of global climate models has contributed to the further understanding of the Earth’s climate. In 2009 his first book, *Storms of My Grandchildren*, was published.

James Hansen has refined climate change models, focusing on the balance between aerosols and greenhouse gases. He believes that there is a danger that climate change will become much more rapid if the balance shifts towards the greenhouse gases.

Hansen’s Congressional testimony leads to broad public awareness of the dangers

In 1988, Prof. Hansen was asked to testify before the US Congress on the danger of uncontrolled climate change. The testimony marked the start of broad public awareness

¹²<https://www.youtube.com/watch?v=2bRrg96UtMc>



Figure 8.14: **Prof. James Hansen**

of the seriousness of the danger, and it was reported in a front page article by the New York Times. However, Hansen believes that governmental energy policies still favor fossil fuels. Therefore he has participated in public demonstrations and he was even arrested in 2011 together with more than a thousand other activists for protesting outside the White House.

James Hansen's TED talk and book

In 2012 he presented a TED Talk: *Why I Must Speak Out About Climate Change*. This talk is easily available on the Internet, and it should be required viewing for everyone who is concerned with the earth's future.

Hansen's book, *Storms of My Grandchildren: The Truth About The Coming Climate Catastrophe, and Our Last Chance To Save Humanity* was published in New York by Bloomsbury Publishing in 2009.

Suggestions for further reading

1. Abarbanel A, McClusky T (1950) *Is the world getting warmer?* Saturday Evening Post, 1 Jul, p22
2. Bagdikian BH (2004) *The New Media Monopoly*. Boston, MA, USA: Beacon
3. Bennett WL (2002) *News: The Politics of Illusion, 5th edition*. New York, NY, USA: Longman
4. Boykoff MT, Boykoff JM (2004) *Balance as bias: global warming and the US prestige press*. *Glob Environ Change* **14**: 125-136
5. Boykoff MT, Boykoff JM (2007) *Climate change and journalistic norms: A case study of U.S. mass-media coverage*. *Geoforum* (in press)
6. Carey JW (1989) *Communication as Culture: Essays on Media and Society*. Boston, MA, USA: Unwin Hyman
7. Carvalho A (2005) *Representing the politics of the greenhouse effect: Discursive strategies in the British media*. *Critical Discourse Studies* **2**: 1-29
8. CEI (2006) *We Call it Life*. Washington, DC, USA: Competitive Enterprise Institute
9. Cowen RC (1957) *Are men changing the earth's weather?* Christian Science Monitor, 4 Dec, p13
10. Cushman JH (1998) *Industrial group plans to battle climate treaty*. New York Times, 26 Apr, p1
11. Doyle G (2002) *Media Ownership: The Economics and Politics of Convergence and Concentration in the UK and European Media*. London, UK: Sage Publications
12. Dunwoody S, Peters HP (1992) *Mass media coverage of technological and environmental risks: A survey of research in the United States and Germany*. *Public Underst Sci* **1**: 199-230
13. Entman RM (1993) *Framing: toward clarification of a fractured paradigm*. *J Commun* **43**: 51-58
14. Fleming JR (1998) *Historical Perspectives on Climate Change*. Oxford, UK: Oxford University Press
15. Gelbspan R (1998) *The Heat Is On*. Cambridge, MA, USA: Perseus Books
16. Grove RH (2003) *Green Imperialism*. Cambridge, UK: Cambridge University Press
17. Leggett J (2001) *The Carbon War*. New York, NY, USA: Routledge
18. McChesney RW (1999) *Rich Media, Poor Democracy: Communication Politics in Dubious Times*. Urbana, IL, USA: University of Illinois Press
19. McComas K, Shanahan J (1999) *Telling stories about global climate change: Measuring the impact of narratives on issue cycles*. *Communic Res* **26**: 30-57
20. McCright AM (2007) *Dealing with climate change contrarians*. In Moser SC, Dilling L (eds) **Creating a Climate for Change: Communicating Climate Change and Facilitating Social Change**, pp 200-212. Cambridge, UK: Cambridge University Press
21. McCright AM, Dunlap RE (2000) *Challenging global warming as a social problem: An analysis of the conservative movement's counter-claims*. *Soc Probl* **47**: 499-522
22. McCright AM, Dunlap RE (2003) *Defeating Kyoto: The conservative movement's impact on U.S. climate change policy*. *Soc Probl* **50**: 348-373

23. Mooney C (2004) *Blinded by science*. Columbia Journalism Review 6(Nov/Dec), www.cjr.org
24. NSF (2004) Science and Engineering Indicators 2004. Washington, DC, USA: National Science Foundation Project for Excellence in Journalism (2006) *The State of the News Media 2006*. Washington, DC, USA:
25. Project for Excellence in Journalism. www.stateofthenewsmedia.org Rajan SR (2006) *Modernizing Nature*. Oxford, UK: Oxford University Press
26. Sandell C, Blakemore B (2006) *ABC News reporting cited as evidence in congressional hearing on global warming*. ABC News, 27 Jul, <http://abcnews.go.com>
27. Shabecoff P (1988) *Global warming has begun, expert tells senate*. New York Times, 24 Jun, pA1
28. Shrader-Frechette KS (1993) *Burying Uncertainty*. Berkeley, CA, USA: University of California Press
29. Starr P (2004) *The Creation of the Media: Political Origins of Modern Communications*. New York, NY, USA: Basic Books
30. Ungar S (1992) *The rise and (relative) decline of global warming as a social problem*. Sociol Q **33**: 483-501
31. Weart SR (2003) *The Discovery of Global Warming*. Cambridge, MA, USA: Harvard University Press
32. Weingart P, Engels A, Pansegrau P (2000) *Risks of communication: Discourses on climate change in science, politics, and the mass media*. Public Underst Sci **9**: 261-283
33. Wilkins L (1993) *Between the facts and values: Print media coverage of the greenhouse effect, 1987-1990*. Public Underst Sci **2**: 71-84
34. Wilson KM (1995) *Mass media as sources of global warming knowledge*. Mass Communication Review **22**: 75-89
35. Wilson KM (2000) *Communicating climate change through the media: Predictions, politics, and perceptions of risks*. In Allan S, Adam B, Carter C (eds) **Environmental Risks and the Media**, pp 201-217. New York, NY, USA: Routledge
36. Zehr SC (2000) *Public representations of scientific uncertainty about global climate change*. Public Underst Sci **9**: 85-103
37. O.N. Larsen, ed., *Violence and the Mass Media*, Harper and Row, (1968).
38. R.M. Liebert et al., *The Early Window: The Effects of Television on Children and Youth*, Pergamon, Elmsford, NY, (1982).
39. G. Noble, *Children in Front of the Small Screen*, Constable, London, (1975).
40. H.J. Schneider, *Das Geschäft mit dem Verbrechen. Massenmedien und Kriminalität*, Kindler, Munich, (1980).
41. W. Schramm, ed., *Grundfragen der Kommunikationsforschung*, Munich, (1973).
42. J.L. Singer and D.G. Singer, *Television, Imagination and Aggression: A Study of Preschoolers*, Erlbaum, Hillsdale, NY, (1981).
43. O.N. Larsen, ed., *Violence and the Mass Media*, Harper and Row, (1968).
44. H.J. Skornia, *Television and Society*, McGraw-Hill, New York, (1965).

45. D.L. Bridgeman, ed., *The Nature of Prosocial Behavior*, New York, Academic Press, (1983).
46. N. Eisenberg, ed., *The Development of Prosocial Behavior*, New York, Academic Press, (1982).
47. W.H. Goodenough, *Cooperation and Change: An Anthropological Approach to Community Development*, New York, Russell Sage Foundation, (1963).
48. J.R. Macauley and L. Berkowitz, *Altruism and Helping Behavior*, Academic Press, New York, (1970).
49. P. Mussen and N. Eisenberg, *Roots of Caring, Sharing and Helping*, Freeman, San Francisco, (1977).
50. J.P. Rushton and R.M. Sorrentino, eds., *Altruism and Helping Behavior*, Erlbaum, Hillsdale, NJ, (1981).
51. L. Wispé, ed, *Altruism, Sympathy and Helping*, Academic Press, New York, (1978).
52. J.-C. Guedon, *La Planète Cyber, Internet et Cyberspace*, Gallimard, (1996).
53. J. Segal, *Théorie de l'information: sciences, techniques et société, de la seconde guerre mondiale ' l'aube du XXI siècle*, Thèse de Doctorat, Université Lumière Lyon II, (1998), (<http://www.mpiwg-berlin.mpg.de/staff/segal/thesis/>)
54. H. von Foerster, editor, *Cybernetics - circular, causal and feed-back mechanisms in biological and social systems*. Transactions of sixth-tenth conferences, Josiah J. Macy Jr. Foundation, New York, (1950- 1954).
55. G. Bateson, *Communication, the Social Matrix of Psychiatry*, Norton, (1951).
56. G. Bateson, *Steps to an Ecology of Mind*, Chandler, San Francisco, (1972).
57. G. Bateson, *Communication et Société*, Seuil, Paris, (1988).
58. R.M. Liebert et al., *The Early Window: The Effects of Television on Children and Youth*, Pergamon, Elmsford, NY, (1982).
59. G. Noble, *Children in Front of the Small Screen*, Constable, London, (1975).
60. J.L. Singer and D.G. Singer, *Television, Imagination and Aggression: A Study of Preschoolers*, Erlbaum, Hillsdale, NY, (1981).

Index

- 350.org, 102
- Abandon the pursuit of growth, 104
- Abolition of nuclear weapons, 191
- Abolition of war, 184, 191
- Abrupt climate change, 326
- Absolute temperature, 73
- Accelerated melting, 320
- Acceleration of cultural change, 143
- Accents, 144
- Accident waiting to happen, 167, 197
- Accidental nuclear war, 167, 185, 191, 197, 202
- Accidents, 199
- Acidification of oceans, 316
- Act of Valor, 181
- Active site, 31
- Adams, John, 350
- Adaptor molecule, 33
- Adenine, 30
- Admiral von Turpitz, 152
- Adolf Hitler, 155
- Advertisers on mass media, 359
- Aesthetic aspects, 68
- Affordable electric cars, 92
- Africa, 60, 79, 174, 227, 230, 233, 235
- African voting rights, 263
- Agent Orange, 189
- Aggression, 136, 140
- Agricultural research, 224
- Agricultural yields, 230
- Agriculture, 102, 169, 171, 192, 231
- Agrobacterium tumofaciens, 39
- Air conditioners, 65
- Airbus, 177
- Al Gore, 360
- Al-Qaeda, 173, 201
- Alaska, 79, 143, 253
- Albedo effect, 313, 320, 326
- Aleutian Islands, 79
- Algae, 77
- All-destroying nuclear war, 102
- Alliance for Climate Protection, 360
- Already-defeated Japan, 351
- Alternative for Germany party, 252
- Alternative media, 359
- Altruism, 140, 142
- Aluminum foil, 65
- Aluminum, production of, 69
- Aluminum-covered plastics, 61
- Amazon destruction planned, 283
- Amazon fires, 104
- Amazon rainforest dieback, 326
- America's top-heavy wealth distribution, 350
- American Nazi Party, 287
- American Security Project, 251
- American Sniper, 181
- Americium, 203
- Amino acid sequences, 32
- Amino acids, 31, 33
- Ammonia, 65
- Amsterdam, 104
- An Inconvenient Truth, 360
- Anaerobic digestion, 77
- Ancestor worship, 144
- Anglo-Saxon master race, 263
- Aniline dyes, 15
- Animal feed, 232
- Annan, Kofi, 170, 202
- Annapolis River, 71
- Anode, 82

- Antarctic sea ice loss, 326
 Anthropocene, 180
 Anthropocene Extinction, 319
 Anthropogenic climate change, 203
 Anti-communism, 286
 Anti-ecological policies, 104
 Anti-gay demonstration in Russia, 287
 Anti-Jewish pogrom in Kaunas, 264
 Anti-science disinformation campaigns, 127
 Anti-semitism, 286
 Antibiotic-resistance marker, 39
 Antibodies, 23
 Anticommunist alternative, 157
 Antifreeze, 65
 Antigens, 23
 Antihuman weapons, 351
 Antimalarial program, 185
 Anxiety about the future, 187
 Apartheid system, 263
 Aquifers, 230, 233
 Arab nationalism and Islam, 147
 Arab Spring, 251
 Arable land, 227
 Architecture, 62
 Arctic methane release, 326
 Arctic oil, 117
 Arctic sea ice loss, 320, 326
 Area of cropland, 230
 Area under food production, 231
 Argentina, 226
 Arid grasslands, 230
 Aridity, 232
 Armaments (\$1.7 trillion spent on), 185
 Armaments race, 152, 154
 Arms control agreements, 180
 Arms manufacturers, 154
 Arms race, 152
 Army training program, 182
 Art objects, 143
 Article VI, 167, 196
 Artificial fertilizers, 238
 Aryan-Hyperborean blood, 287
 Aryans, 264
 Asia, 198
 Assange, Julian, 351
 Assassination attempts, 201
 Assassinations, 352
 Asteroids, 167, 197
 Astonishing deceit, 365
 Astonishing degree of cynicism, 127
 Asylum, 188
 Atlas Network, 127
 Atmosphere of Venus, 372
 Atmospheric water vapor, 320
 Atom bomb, 139
 Atrocities, 139, 259
 Attenborough, Sir David, 56, 361, 363
 Auschwitz, 155
 Australia, 226
 Australian bush fires, 104
 Australian politicians, 104
 Austria, 69
 Austria-Hungary, 152
 Autocatalytic systems, 41
 Automobiles make our cities unpleasant, 88
 Autoradiography, 31
 Avery, O.T., 30
 Awnings, 65

 Börjesson, Pål, 75
 Baba Yar, 264
 Bacterial cell wall, 31
 Bacteriophages, 33, 38
 BAE Systems, 177
 Ban Ki-moon, 369
 Bangladesh, 62
 Bangladesh, 30 million refugees, 251
 Bank of China, 116
 Banking on Climate Change 2019, 116
 Banks aligned with climate disaster, 117
 Banks sponsor fossil fuel giants, 120
 Baraka, Hoda, 102
 Barclays, 116
 Barlow, Maude, 324
 Barnaby, Frank, 202
 Bathurst, Chris, 71

- Battleships, 154
Bay of Fundy, 71
BBC, 363
Beach, David, 71
Beadle, George, 32
Beatrix Potter, 330
Bedjaoui, Muhammad, 166, 195
Bee populations declining, 340
Before the Flood, 369
Behind Enemy Lines, 181
Belarus, 198
Benedin, Edouard van, 29
Benefits of equality, 347, 348
Berg, Paul, 38
Bering Strait, 143
Bernal, J.D., 31
Bernard Lowen, 191
Bernie Sanders, 371
Bhutto, Zulfikar Ali, 201
Biden tainted by corporate money, 276
Biden, Joe, 276
Binary plants, 81
Biodiversity, 239, 286
Biodiversity loss, 316
Biogas, 77
Biological annihilation, 319
Biological diversity, 319
Biology of War and Peace, 144
Biomass, 61, 62, 74-76
Biosphere, 313
Biosynthesis of hemoglobin, 32
Biosynthesis of proteins, 33
Birth anomalies, 189
Birth control, 224, 239, 253
Birth control programs, 239
Birth of an Island, 334
Black Hawk Down, 181, 182
Black legion sign, 287
Blair, Bruce G., 167, 197
Blastocysts, 39
Boeing, 177
Bohr, Niels, 199
Bohr-Wheeler theory, 199, 200
Bolsonaro on homosexuals, 283
Bolsonaro, Jair, 104, 283
Books by Lester R. Brown, 100
Boreal forest dieback, 326
Borlaug, Norman, 227
Bottom half of humanity, 350
Brazil, 69, 227, 286
Bread and circuses, 329, 355
Breivik, Anders Behring, 184
Bremer, Sidney, 33
Brexit, 180
Brexit and refugees, 251
Britain, 152
British colonial India, 260
British imperialism, 263
Brose Eric, 152
Brown, Lester R., 100, 233
Brunch With Bernie, 371
Brundtland Report, 231, 232
Brutal, violent attack, 283
Brutalization of values, 154
Buchenwald, 264
Buchenwald extermination camp, 264
Buffet, Warren, 348
Burial customs, 144
Burned at the stake, 351
Burnet, Sir Frank Macfarlane, 23
Bush family and Hitler, 155
Bush fires in Australia, 104
Bush political dynasty, 156
Bush, George W., 155
Bush, Prescott, 155
Bush/Nazi connection, 156
Business as usual, 104
Business-as-usual scenario, 248
César Milstein, 23
Cairo population conference, 241
Caldecott, Helen, 157
Call of Duty, 184
Calogero, Francesco, 168
Cambridge University, 30, 32
Campaigns that confuse the public, 127

- Canada, 69, 81, 226
 Canadian Arctic, 253
 Cancer caused by radioactivity, 189
 Cancer therapy, 27
 Carbon budget, 57, 117
 Carbon emissions, 62
 Carbon footprint, 57
 Care for our children, 102
 Carrying capacity, 226
 Carson, Rachel, 330
 Caste markings, 144
 Catastrophic climate change, 53, 56, 88, 102, 271, 313, 358
 Catastrophic global war, 154
 Catastrophic mistake, 167, 197
 Catastrophic nuclear war, 170, 171, 190, 192
 Cathode, 82
 Ceballos, Gerardo, 319
 Cellulostic ethanol, 78
 Celtic cross, 287
 Central Atlantic region, 79
 Central banks, 263
 Ceremonies, 144
 Cerrado, 227
 Chad, 174
 Chadors, 144
 Chain-reacting pile, 200
 Chance of survival, 170
 Changes of diet, 253
 Chargaff, Erwin, 30
 Charge acceptors, 60
 Charge distributions, 16
 Charge donors, 60
 Chemical bonds, 62
 Chemical pesticides, 336
 Chemical properties, 199
 Chemical warfare, 189
 Chemotherapy, 15
 Cheney, Brig. Gen. Stephen, 251
 Chernobyl disaster, 198
 Child author, 330
 Child mortality rates, 223
 Child soldiers, 187
 Children as young as 2 or 3, 277
 Children in cages, 276, 278
 Children killed by wars, 165, 195
 Children killed in war, 186
 Chimeric animals, 39
 China, 69, 176, 230, 233, 241
 Chromatography, 31
 Chromosomal maps, 29
 Chromosomes, 29
 CIA, 272, 351, 352
 Circumcision, 144
 Civil society, 170
 Civil war, 174
 Civil wars, 174, 186
 Civilian victims of war, 165, 195
 Civilians are hostages, 184
 Civilians as targets, 170
 Civilians killed in war, 186
 Civilization and Christianity, 260
 Clark, General Wesley, 173
 Class warfare, 348
 Classical genetics, 27
 Clean energy, 56
 Climate and environment, 180
 Climate change, 62, 102, 199, 203, 224, 230, 232, 313
 Climate Change and Disasters, 249
 Climate change and war, 251
 Climate change as genocide, 248
 Climate change denial, 124, 271, 356
 Climate change emission pledges, 316
 Climate Change: The Facts, 363
 Climate crisis, 55, 57, 59, 117
 Climate Crisis Summit, 104
 Climate emergency, 53–55, 104
 Climate financing, 317
 Climate refugees, 249
 Climate strikes, 104
 Climate tipping points, 326
 Clinton, Bill, 369
 Clinton, Hillary, 276
 Clonal theory of immunity, 23
 Cloning, 39

- Cloud cover, 62, 74, 77
- Cluster bombs, 189
- Coal, 203
- Coal and steel, 156
- Coal mining, 120
- Coal power, 120
- Coal, oil and gas production, 102
- Coal-burning plants, 66
- Coal-fired power plant, 120
- Coastal cities threatened, 249
- Codons, 33
- Cold reservoir, 73
- Cold War, 167, 174, 185, 197, 352
- Collapse of our civilization, 56
- Collective paranoia, 184
- Columbia University, 29
- Columbia University, Climate Science, 372
- Colonialism, 259, 347
- Colonialism and World War I, 154
- Come together and save ourselves, 358
- Common Dreams, 102
- Communal aggression, 139
- Communal defense response, 136, 140
- Communist Party, 157
- Competition, 143
- Complementarity, 15, 33
- Compressed hydrogen gas, 82
- Computer games, 182
- Concentrating photovoltaics, 60, 61
- Conflict and refugees, 250
- Conflicts and climate change, 249
- Conflicts and famine, 248
- Congo, 259
- Conservatories, 65
- Consolidated Silesian Steel, 156
- Construction and maintenance, 231
- Construction energy, 66
- Consume more, 359
- Container ships, 202
- Control government policy, 352
- Convection currents, 79
- Cook Strait, 71
- Cooking, 65, 77, 231
- Cooking, solar, 65
- Cooperation, 140
- COP24, 55
- Corbyn, Jeremy, 53
- Core meltdown, 198
- Corn silk, 232
- Corporate oligarchs, 352
- Cost of war, 154
- Costa Rica, 102
- Council of Canadians, 324
- Council on Foreign Relations, 263
- Countercurrents, 104
- Courage, 139
- Cretaceous-Paleogene Extinction, 317
- Crick, Francis, 30, 33
- Crimes against humanity, 104
- Crisis, 147
- Critical mass, 199, 202
- Crop failures, 232
- Crop wastes, 74
- Cropland, 235
- Cropland per capita, 236, 241
- Cropland, area of, 230
- Cropland, limitations on, 227
- Crossing, 29
- Crown gall, 39
- Cruelty by children, 144
- Crusades, 147
- Crystallography, 30
- Cuban Missile Crisis, 157
- Cubic relationship, 66
- Cultural barriers to marriage, 143
- Cultural evolution, 143
- Cultural inertia, 56
- Culture of violence, 174, 181
- Cumulative risk, 170
- Currents of molten material, 79
- Cytosine, 30
- Damage to infrastructure, 188
- Dances and songs, 144
- Dangers of nuclear power, 198
- Danish economy, 66

- Dark branches of government, 272
Darkened snow, 320
Darrieus wind turbine, 66
Darwin, Charles, 27, 28, 37, 136, 144
Davis, Ron, 38
Davos Economic Forum, 57
DDT, 336, 340
De Vries, Hugo, 28
Deadly climate conditions, 250
Deadly heat waves, 250
Decay of democracy, 163
Deciduous trees, 65
Declaration of Human Rights, 188
Decline of Arctic sea ice, 104
Deep state, 352
Deep wells, 81
Definition of genocide, 278
Deforestation, 65, 235, 236, 283
Deforestation in Brazil, 104
Degradation of topsoil, 236, 340
Deliberately misled on climate change, 104
Demand, 230
Democracy requires knowledge, 351
Democratic Republic of Congo, 174
Demographic transition, 239
Demographic trap, 239
Demonizing the Squad, 281
Denazification, 286
Denmark, 66
Deoxynucleotides, 41
Depleted uranium shells, 189
Depletion of minerals in soil, 230
Desert areas, 60, 61, 77, 82
Desertification, 230, 249
Destruction of forests, 235, 361
Destruction of habitats, 319
Destruction of nature, 104
Deterrence, flaws in concept, 165, 194
Developing countries, 65
Developing world, 316
Development, 185, 239
Devil's Dynamo, 163
Devotion, 139, 140
Dialects, 144
DiCaprio, Leonardo, 369, 372
Dictatorships, 351
Diction, 144
Diet, 144
Dietary changes, 253
Direct costs of war, 185
Directly used fuels, 203
Dirty wars, 352
Dirzo, Rudolfo, 319
Disarmament, 165, 195
Disasters might wake public, 361
Disease, 174
Disease-resistant strains, 227
Diseases related to poverty, 185
Disempowered TV viewers, 329, 355
Disinformation campaign, 127
Displaced persons, 249
Distanced from killing, 184
Distribution problems, 230
Diverse populations, 142
Divest from the fossil fuel industry, 125
DNA, 33
DNA ligase, 38
DNA structure, 30
Dominant genes, 28
Double envelope construction, 65
Double-stranded DNA, 31
Dreadnought-class ships, 152
Drinking water, 249
Drone operators, 184
Drought, 230, 316
Drug addiction, 157
Dry steam, 81
Drying of forests and fires, 324
Dual use power plants, 62
Dung, 74
Duty to future generations, 102
Dwarf peas, 27
Dysentery, 239
E. coli, 38
Earth Policy Institute, 100

- Earth's atmosphere, 372
 Earth's crust, 79
 Earth's rotation, 71, 79
 Earthquake activity, 79
 Earthquakes, 71
 East Asia, 176
 Eastern Asia, 227
 Eastern Europe, 198
 Eco RI, 38
 Ecological catastrophes, 328, 355
 Ecological damage, 189
 Economic influence, 163
 Economic tipping point, 361
 Economic waste, 203
 Ecosystem functioning, 319
 Ecstasy, 140
 Education, 185
 Education for women, 241
 Edward Snowden, 352
 Effects of war on children, 187
 Efficiency, maximum, 73
 Egg cells, 29
 Ehrlich, Paul, 15
 Ehrlich, Paul R., 319
 Eibl-Eibesfeldt, Irenäus, 143, 147
 Eisenhower's farewell address, 163
 ElBaradei, Mohamed, 168, 202
 Electric cars, 91, 92
 Electric vehicles, 88, 92
 Electrical generating plants, 188
 Electrical power, 61, 62
 Electrical power costs, 66
 Electrical power generation, 62
 Electrical power grids, 68
 Electricity generation, 60, 66, 77, 81, 200, 203
 Electrochemical reactions, 82
 Electrode material, 82
 Electrolysis of water, 60, 82, 83
 Electron microscopy, 31, 33
 Electron spin resonance, 31
 Electrophoresis, 31, 41
 Electrostatic complementarity, 15
 Electrostatic forces, 31
 Elephant in the room, 272
 Eliminating democracy, 352
 Elitist goal, 263
 Ellsberg, Daniel, 351
 Elon Musk, 92
 Emergency, 54
 Emergency-scale transition, 359
 Emissions reduction curve, 359
 Emotions, 135
 End of the fossil fuel era, 102
 Endemic conflict, 174
 Energy, 317
 Energy crisis, 69, 199
 Energy efficiency, 62
 Energy from the Ocean, 71
 Energy inputs of agriculture, 230
 Energy payback ratio, 66
 Energy savings, 65
 Energy storage, 69, 82
 Energy-intensive agriculture, 226, 231
 Enrichment, 168
 Enthalpy, 79
 Environmental catastrophe, 357
 Environmental crisis accelerates, 357
 Environmental destruction, 286
 Environmental disaster, 359
 Environmental holocaust, 189
 Environmental Protection Agency, 272
 Enzymes, 32
 Epidemics, 186
 Equity, 200
 Eradication of indigenous people, 104
 Eradication of smallpox, 185
 Eritria, 174
 Erosion, 235
 Erratic decisions and lies, 276
 Escalatory cycles of violence, 165, 194
 Ethical principles, 147, 165, 194
 Ethics, 102
 Ethiopia, 174
 Ethnic diversity, 142
 Ethnic identity, 143

- Ethnicity, 143
- Ethnicity and religion, 147
- Ethology, 135, 136
- Eugenics movement, 263
- Europe, 62
- Europe's right-wing parties, 252
- European colonial conquests, 147
- Exceptionalism, 259, 260
- Excess charge, 16
- Excess human mortality, 250
- Excessive use of pesticides, 104
- Execution of Polish teachers, 264
- Existential crisis, 369
- Expanded German navy, 152
- Expansion of North Sea oil, 369
- Exploitation, 259, 260
- Exporting coal and beef, 104
- Expression of emotions, 135
- Extension of my personality, 90
- External circuit, 82
- Extinction of marine species, 318
- Extinction of terrestrial vertebrates, 318
- Extinction Rebellion, 54, 365
- Extortion, 202
- Extrachromosomal genetic systems, 237
- Extreme weather events, 104
- Exxon had the best climate models, 124
- Exxon knew, 124
- Exxon's 1982 internal memo, 125

- F-factors, 38
- Fallout, 166, 196
- Family planning, 239, 253
- Famine, 56, 169, 186, 224, 226, 233, 241
- Famine in Somalia, 248
- Famine relief, 185
- Famine used in war, 248
- Fanaticism, 140
- FAO, 227
- Farm buildings, 231
- Farm wastes, 77
- Fascism, 283
- Fascist forces, 104

- Fast breeder reactors, 200
- Fast neutrons, 200
- Fatal accident, 168
- Favelas, 239
- Fear of communism, 157
- Feedback loop, definition, 320
- Feedback loops, 313
- Feedstocks for fertilizer, 231
- Feedstocks for pesticides, 231
- Fermi, Enrico, 200
- Fertility of mixed marriages, 143
- Fertilizers, 230
- Fiber optics, 65
- Fischer, R.A., 140
- Field machinery, 231
- Figures. Christina, 102
- Filed teeth, 144
- Films that glorify war, 181
- Financial architects of Nazism, 155
- Financing fossil fuel expansion, 117
- Finland, 76, 198
- Fire destruction a dominant factor, 104
- Fire storms, 104, 171, 192
- Firebombing of Dresden, 165, 195
- Fish ladders, 69
- Fission of uranium, 199
- Fission reaction, 190
- Fissionable isotopes, 168, 200
- Fissionable materials, 202
- Flags, 140
- Flemming, Walther, 29
- Flood control, 69
- Floods, 316
- Fly more, 359
- Fly squad, 29
- Focal axis, 61, 62
- Food calorie outputs, 231
- Food calories per capita, 232
- Food per capita, 235
- Food production, 227
- Food security, 249, 250
- Food-exporting countries, 226
- Foreign DNA, 39

- Forest fires, 324
 Forest industry, 76
 Forest loss, 235
 Forge of Empires, 184
 Former Soviet Republic, 227
 Former Soviet Union, 176
 Fossil Free MIT, 125
 Fossil fuel corporations, 124, 356
 Fossil fuel energy inputs, 231
 Fossil fuel expansion, 117
 Fossil fuel extraction must stop, 56
 Fossil fuel infrastructure, 104
 Fossil Fuel Report Card, 116
 Fossil fuels, 66, 100, 125, 230
 Fourth Amendment trashed, 352
 Fourth Reich, 286
 Fracked oil, 120
 Framework Convention, 316
 France, 152, 176
 France bans internal combustion engine, 91
 Frank Macfarlane Burnet, 23
 Franklin, Rosalind, 30
 Free public transport in Luxembourg, 88
 Freedom Party (Austria), 252
 French fascist groups, 287
 Fridays for the Future, 59
 Friedrich Krupp AG, 154
 Frisch, Karl von, 136
 Fruit flies, 29
 Fuel cells, 60, 77, 82
 Full employment, 104
 Full Spectrum Warrior, 182
 Fully electric cars, 91
 Fusion energy, 203
 Future generations, 102
 Future of our civilization, 369

 Gabriel, Dalia, 263
 Galileo, 351
 Garrod's hypothesis, 32
 Garrod, Archibald, 32
 Geisler, Charles, 249
 Gene-spliced bacteria, 39
 General Dynamics, 177
 General Groves, 351
 General Motors electric car, 92
 General strike for climate action?, 369
 Genes, 140
 Genespinning, 39
 Genetic change, 143
 Genetic code, 33
 Genetic engineering, 38
 Genetic lottery, 28
 Genetic material, 31
 Genetic pool, 190
 Genetically homogenous tribes, 142
 Genetics, 27
 Genocide, 147, 165, 195, 248, 259, 264
 Genocide against Jews, 147
 Genocide of Amerinds, 260
 Genomic DNA, 40
 George H.W. Bush, 155
 George W. Bush, 155
 Georges Köhler, 23
 Geothermal energy, 76, 79
 Geothermal power, 79
 Geothermal power plants, 80
 German nationalism, 147
 German naval buildup, 152
 Germans applauding Adolf Hitler, 264
 Germans shooting women and children, 264
 Germany, 152
 Germany bans internal combustion engine, 91
 Germany's armament industry, 155
 Giampietro, Mario, 231
 Gigafactory 1, 92
 Gigafactory 2, 92
 Gilbert, Walter, 39
 Glacial periods, 233
 Glaciation, 319
 Glaring contradiction, 352
 Glickson, Andrew, 104
 Global climate, 286
 Global climate strike, 59
 Global governance, 102, 224

- Global hegemony, 176
 Global Inequality organization, 350
 Global number of child deaths, 224
 Global power, 176
 Global surface temperature, 104
 Global temperature, 313
 Global warming, 62, 199, 203, 230, 250, 316
 Global warming and security, 251
 Goddard Institute, Space Studies, 372
 Golden Dawn in Greece, 287
 Golden Dawn party (Greece), 252
 Goodman, Amy, 54, 173
 Gordiano Bruno, 351
 Gore, Al, 360
 Governance, 102
 Governments left to wither, 358
 Grain production, 235
 Graphite electrodes, 82
 Graphite moderator, 200
 Grasslands, 230
 Grave implications, 163
 Great Depression, 330
 Great famine of 1876-1878, 260
 Great-power competition, 176
 Greatest failure of humankind, 369
 Greece, 79, 152
 Greed, 259
 Green Berets, 182
 Green New Deal, 104
 Green Party, 272
 Green Revolution, 227, 230, 238
 Greenhouse effect, 320
 Greenhouse gas emissions, 250, 252
 Greenhouse gases, 77
 Greenhouses, 62
 Greenland, 198, 253
 Greenland and Antarctic ice sheets, 104
 Greenland ice cores, 326
 Greta Thunberg meets Pope Francis, 365
 Greta Thunberg speaks at Marble Arch, 367
 Grey, Colin S., 167, 197
 Grids, 68
 Griffin, G. Edward, 263
 Gross, wholesale spying, 352
 Groundwater, 233
 Group identity, 142
 Group selection, 140
 Growth of science and technology, 102
 Growth of wind power, 66
 Guanine, 30
 Guardian, 54
 Guilt, 165, 195
 Gulf of Maine, 71
 Gulf War of 1990, 188, 189
 Gun-type bomb, 202
 Guns, 154
 Guns in schools?, 181
 Guterres, Antonio, 56

 Habias Corpus trashed, 352
 Habitai II Conference, 243
 Haemophilus influenzae, 38
 Hair standing on end, 139
 Hair-trigger alert, 167, 197
 Haldane, J.B.S., 140
 Half of Congo's people killed, 260
 Half-reactions, 82
 Halt extraction of fossil fuels, 56
 Hamilton, W.D., 140
 Hanauer, Nick, 348
 Hansen's testimony to Congress, 373
 Hansen, James, 372
 Hartmann, Thom, 371
 Harvesting, 75
 Health, 317
 Health and social problems, 348
 Heat engines, 73
 Heat exchange, 65
 Heat flow, 79
 Heat pumps, 65, 68
 Heat waves, 316
 Heat-collecting plate, 65
 Heaters, 77
 Heating of houses, 81
 Heiliger Schauer, 139
 Heliostatic reflectors, 62

- Hemoglobin, 31, 32
Henderson, Bill, 358
Hepatitis, 239
Herbicides, 189
Hereditary disease, 32
Hero face, 139
Heroic behavior, 140
Heroism, 136
HEU, 200
Hierarchal relationship, 33
High enthalpy resources, 79
High-yield grain varieties, 230
High-yield strains, 227
Higher status for women, 241
Highly enriched uranium, 168, 200
Highly-enriched uranium, 170
Highway development, 236
Hillsides, 235
Himmler, Heinrich, 264
Hiroshima, 140, 190, 198–200
History, 144
History of Racism, 259
Hitler as Chancellor, 157
Hitler Youth, 140
Hitler's rise to power, 154, 156, 157
Hitler, Adolf, 286, 300
Hitler-Trump parallels, 300
HMS Dreadnought, 152
Hobson, John A., 347
Hodgkin, Dorothy Crowfoot, 31
Holocaust, 264
Holocaust denial, 286
Holocene Extinction, 319
Holy shiver, 136
Hong Kong, 239
Honge oil, 76
Hoodbhoy, Pervez, 201
Hope for the future, 142
Hospitality, 144
Hot dry rock method, 81
Hot reservoir, 73
House of Commons, 53
Howitzers, 154
Human error and nuclear war, 191
Human failings, 167, 197
Human hands as currency, 260
Human life will have no value, 286
Human misery, 227
Human nature, 144
Human rights, 120
Human rights in Brazil, 286
Human rights trashed, 352
Human Rights Watch, 277
Humane response to refugees, 252
Humanitarian crisis, 251
Humanitarian law, 165, 167, 195, 196
Humanitarian tragedies, 180
Humans cause global warming, 316
Hungarian Skins, 287
Hunger, 104
Hunter-gatherers, 143
Huntington Ingals, 177
Hybrid cars, 91
Hybrids, 27
Hydraulic motors, 72
Hydroelectric power, 69
Hydroelectric storage, 68
Hydrogen, 60, 82
Hydrogen bonds, 31
Hydrogen from algae, 77
Hydrogen technology, 68, 72, 77, 82
Hydrological cycle, 171, 193
Hydrophilic groups, 31
Hydrophobic groups, 31
Hydropower, 62, 69, 76

IAEA, 202
Ice mass of Antarctica, 104
Ice mass of Greenland, 104
Iceland, 69, 79
Illegal lumbering condoned, 104
Illegal we do at once, 352
Illegality of nuclear weapons, 165, 195
Illiteracy, 185
Ilya Mechnikov, 21
Immediate action required, 56, 251

- Immortal clones of lymphocytes, 27
 Immune systems, 21
 Immunity, mechanism of, 15
 Imperialism, 263
 Imperialism, A Study, 347
 Imported oil, 75
 Imprinting, 136
 Improved storage batteries, 92
 Inballanced diet, 340
 Incendiary bombings, 171, 193
 Increased arms trading, 180
 India, 73, 170, 176, 227
 India's nuclear weapons, 201
 Indian monsoon disruption, 326
 Indigenous people, 369
 Indigenous protests against oil drilling, 120
 Indirect costs of war, 185
 Indiscriminate cutting of trees, 104
 Indiscriminate mass slaughter, 165, 195
 Indo-China conflicts, 186
 Indonesia, 79, 239
 Industrial Revolution, 152, 347
 Industrialized nations, 347
 Inequality, 348
 Information accumulation, 143
 Infrastructure, 185, 239
 Inhumane treatment at the border, 276
 Initial investment, 61, 65
 Inland rainfall, 235
 Inorganic fertilizer, 231
 Input/output ratio, 231
 Insect apocalypse, 104, 340
 Insect pollination of crops, 104
 Inside Climate News, 124
 Instinctive behavior, 143
 Instincts, 135
 Institution of war, 170, 185
 Institutional inertia, 56
 Insulating shutters, 62
 Insulation, 62
 Insulin, 31
 Intensive farming practices, 340
 Intermittency, 68, 69, 82
 Internal assessments, 125
 Internal combustion engine ban, 90
 Internally displaced persons, 187
 International agreements, 317
 International borders, 188
 International control, 168, 200
 International cooperation, 180
 International law, 224
 Intertribal aggression, 142
 Intertribal massacres, 147
 Intragroup aggression, 136
 Inundation of coastal cities, 316
 Invasion of Transvaal, 152
 Investment opportunity, 90
 Investment, initial, 65
 IPCC, 55, 117, 120, 230, 316, 360
 Iran, 170, 173, 176
 Iran nuclear deal, 180
 Iraq, 173
 Iraq war, 276
 Irish Potato Famine, 230, 238
 Iron and steel company, 154
 Irreversible biodiversity loss, 316
 Irreversible damage to civilization, 190
 Irreversible warming, 124
 Irrigation, 69, 230, 236
 Isotopes, 199, 201
 Isotopes of uranium, 199
 Israel, 176
 Israel's nuclear weapons, 200
 It's not too late, 364
 Italian neo-fascists, 287
 Italy, 79, 152
 Itapú Dam, 69
 Ituri Province of Congo, 147
 IUCN, 319
 James Hansen, 372
 James Hansen's TED talk, 373
 James van Allen, 372
 Japan, 73, 79, 152, 239
 Jaws of power, 351
 Jefferson, Thomas, 350, 351

- Jerne, Niels Kai, 23
Jewish employees, 157
Jobbic party (Hungary), 252
Jobs in renewable energy, 104
JPMorgan Chase, 116
- Köhler, Georges, 23
Kaiser Wilhelm II, 152
Kamchatka Peninsula, 79
Keep that oil in the ground, 57
Kelvin degrees, 73
Kendrew, J.C, 31
Key driver of climate breakdown, 104
KGB, 351
Khan, A.Q., 201
Khorana, H. Gobind, 37
Killing them, 283
Kim Jong-un, 177
Kindness, 140
Kinetic energy, 66
King, Martin Luther, 157
Kings College, London, 30
Kissinger, Henry, 352
Koch brothers, 127
Koch, Robert, 15
Koestler, Arthur, 139
Korean Peoples Army, 177
Kornberg, Arthur, 33
Kosovo, 147
Kristallnacht, 157
Krupp family business, 154
Kurdish civilians gassed, 147
Kurile Island chain, 79
- L-3 Communications, 177
La Grande complex, 69
Lack of action, 316
Land Use Policy, 249
Landfills, 77
Language and ethnic identity, 144
Languages, 143
Lapham, Robert J., 239
Lapps, 143
- Large-scale famine, 102
Largest company in Europe, 154
Last frontier, 227
Last Hours (YouTube), 372
Last Hours of Ancient Sunlight, 371
Late Devonian Extinction, 317
Laterite, 237
Laterization of soil, 237
Latin America, 227
Latitude, 74
Lebanese civil war, 147, 186
Lebanon, 173
Lederberg, Joshua, 38
Leeching by rain, 237
LeMay, General Curtis E., 167, 197
Lenton, Timothy Michael, 326
Leonardo DiCaprio, 369, 372
Leonardo-Finmeccanica, 177
Leopold II, King of Belgium, 259
Leopold's private army, 260
Lerma Rogo, 227
Lethal heat events, 250
LEU, 200
Level playing field, 272
Libya, 173, 233
Life.styles from mass media, 355
Lifestyles, 62
Light of the black sun, 287
Light pipes, 65
Light weapons, 174
Limitations on cropland, 227
Limiting fossil fuel production, 358
Linus Pauling, 23
Liquefied natural gas, 120
Listen to the scientists and act, 104
Literature, 144
Lithium ion batteries, 92
Lithium ion storage batteries, 92
Livestock feed, 231
Living from war, 163
Lobbying against climate change action, 125
Local communities, 144
Lock and key mechanism, 15

- Lockheed Martin, 177
 Lorenz, Konrad, 136, 140, 143
 Los Alamos, 351
 Loss of 175 million lives, 189
 Loss of flying insects, 340
 Loss of life, 186
 Love for nature, 330
 Low enriched uranium, 200
 Low enthalpy resources, 79
 Low-carbon economy, 56
 Loyalty, 139, 140
 Ludendorff, 157
 Lymphocytes, 21
 Lysozyme, 31

 M5, 351
 Mafia, 202
 Magna Carta trashed, 352
 Magnesium, 69
 Magnetic bottles, 203
 Mahler, Halfdan, 239
 Mainstream media, 352
 Major extinction event, 319
 Making excuses, 357
 Malaria, 340
 Malnourished children, 224
 Malnutrition, 185, 186, 316, 340
 Man-made disaster, 56
 Man-made forms of life, 40
 Mantle of the earth, 79
 March in Poland, 287
 Marginal land, 227, 235, 236
 Marine air, 66
 Marine biologist, 330
 Markets solve all problems?, 358
 Marriage, 142
 Marriage across ethnic boundaries, 147
 Martyr to the truth, 351
 Mass media, 88, 182, 271, 272, 353
 Mass migration, 251
 Mass murder of Soviet civilians, 264
 Massacres, 147
 Massive nuclear retaliation, 165, 194

 Massive spying, 352
 Mattas, James, 176
 Matthaei, Heinrich, 33
 Maudlin, W. Parker, 239
 Maximum efficiency, 73
 Meat consumption, 232
 Mechanism of immunity, 15
 Mechnikov, Ilya, 21
 Media as a battleground, 353
 Media neglect of climate change, 328, 355
 Medical consequences of war, 186
 Mendel, Gregor, 27
 Mendelian laws, 28
 Merchants of Doubt, 104
 Merkel, Angela, 252
 Mertz, Janet, 38
 Messenger RNA (mRNA), 33
 Metabolism, 33
 Metal-containing proteins, 32
 Methane, 77, 104
 Methane hydrate feedback loop, 313, 318, 323, 326
 Methane, 10,000 gigatons, 323
 Microscopic fixes for vast problems, 358
 Middle East, 60, 233
 Middle East conflicts, 180
 Miescher, Friedrich, 30
 Migration into Europe, 251
 Migration to cities, 239
 Migration, political reactions, 251
 Migrations, 143
 Militant enthusiasm, 139, 140
 Militarism and money, 135
 Militarism in North Korea, 176
 Military Expenditure Database, 177
 Military technology, 180
 Military-industrial complex, 154, 163, 271
 Mill, John Stuart, 226
 Milstein, César, 23
 Miscalculation, 167, 197
 Miscanthus, 76
 Misplaced power, 163
 Missile defense system, 170

- Missile Envy, 157
 Mistaken for a missile strike, 167, 197
 Mitigation, 317
 Modern feudalist society, 263
 Modern powerholders, 353
 Modern societies, 355
 Modernism, 170
 Molecular biology, 27, 31
 Molecular complementarity, 15
 Molten lava of volcanoes, 81
 Molten salt, 62
 Monbiot, George, 54, 357
 Monetizing underground “assets”, 124, 356
 Money and growth our main concerns, 57
 Mono-cropping, 340
 Monoclonal antibodies, 23, 27
 Monsoon disruption, 326
 Moon’s gravitational field, 71
 Moral responsibility, 57
 More military spending, 180
 More violent conflicts, 180
 Morgan, Thomas Hunt, 29
 Mossad, 351
 Motor traffic in Manila, 88
 Mountain passes, 66
 Movement of refugees, 180
 MUFG in Japan, 116
 Muhith, Abdul, 251
 Muller, Herman J., 29
 Mullis, Kary, 40
 Multigenerational families, 353
 Multinational network, 156
 Multiple interrelated crises, 56
 Muniruzzaman, Maj. Gen, 251
 Murder, 259
 Murder of black people, 264
 Murder of ethnic Poles, 264
 Murder of Soviet citizens, 264
 Murky depths of stupidity, 271
 Musharraf, Pervez, 201
 Musk, Elon, 92
 Mutant genes, 29
 Mutant strains, 32
 Mutations, 28
 Mutually Assured Destruction, 197
 Myoglobin, 31
 Myeloma cells, 27
 Nagasaki, 140, 198–200
 Narrow and shrinking window, 55
 NASA, 372
 Nathans, Daniel, 38
 National Academy of Sciences, 319
 National Book Award, 334
 National Front party, 252
 National Geographic Chanel, 353
 National pride, 170
 National Rifle Association, 181
 Nationalism, 140
 Nationalism and religion, 147
 Nationalism, nuclear, 201
 Natural environment, 361
 Natural gas, 230
 Natural habitat destruction, 319
 Natural resources, 317
 Natural selection, 140
 Nature: Climate Change, 250
 Naval arms race, 152, 157
 Naval supremacy, 152
 Nazi atrocities, 264
 Nazi genocides, 264
 Nazi Germany, 155
 Nazi ideology revived, 286
 Nazi murder of homosexuals, 264
 Nazi Party, 147, 155, 157
 Nazi racism, 264
 Nazi symbols, 286
 Near East, 227
 Neo-Nazi demonstration in Leipzig, 287
 Neo-Nazi skinheads in Spain, 287
 Neo-Nazi symbols in Ukraine, 287
 Neo-Nazism, 286
 Neocolonialism, 259
 Neofascism, 283
 Neoliberalism, 358
 Neptunium, 203

- Nerve endings, 15
 Netherlands bans petrol driven cars, 91
 Network of pipes, 65
 Neuborne, Burt, 300
 Neurospora, 32
 Neutral countries, 165, 195
 Neutrons, 199
 New Agenda Resolution, 167, 196
 New Joan of Arc, 57
 New York Times, 351
 New Zealand, 71, 79, 102
 Nick Hanauer's TED talk, 348
 Niels Kai Jerne, 23
 Nigeria, famine, 248
 Nightmare bacteria, 238
 Nineteen Eighty-Four, 352
 Nirenberg, Marshall, 33
 Nitrous oxide, 104
 Nobel Peace Prize, 360
 Non-Proliferation Treaty, 200
 Nonvoters, 276
 North America, 62, 79
 North Korea, 170, 176
 North Korea's nuclear weapons, 200
 Northern Africa, 227
 Northrop Grumman, 177
 Norway, 69
 Norway bans petrol driven cars, 91
 Norwegian mass-murderer, 184
 Not a single new coal mine, 104
 Novik, Richard, 39
 NPT, 200
 NPT, threatened failure of, 201
 NSA, 272
 Nuclear arms race, 157
 Nuclear black market, 168
 Nuclear catastrophe, 190
 Nuclear darkness, 169
 Nuclear deterrence, flaws, 168
 Nuclear environmental catastrophe, 171, 192
 Nuclear families, 355
 Nuclear fusion, 203
 Nuclear magnetic resonance, 31
 Nuclear nationalism, 201
 Nuclear power dangers, 198
 Nuclear power generation, 157, 199
 Nuclear power plant accidents, 191
 Nuclear proliferation, 168, 199–201
 Nuclear reactor, 200
 Nuclear reactors, 168
 Nuclear terrorism, 168, 170, 201
 Nuclear tests, 189
 Nuclear war, 102
 Nuclear war by accident, 202
 Nuclear warhead stockpiles, 177
 Nuclear weapons, 157
 Nuclear winter, 171, 192
 Nucleon number, 199
 Nuremberg Principles, 203, 351
 Nuremberg rally, 264
 Nuremberg trials, 286
 Nutrient-poor soils, 237
 Obama, Barack, 250, 369
 Obscenely enormous military budget, 272
 Ocasio-Cortez, Alexandria, 104, 281
 Ocean acidity and temperatures, 104
 Ocean energy, 76
 Ocean thermal energy conversion, 73
 Ocha, Sevaro, 33
 Offshore winds, 66
 Ogallala aquifer, 230, 233
 Oil content, 77
 Oil spills, 189
 Oil-rich regions, 352
 Oklahoma, 230
 Older people marginalized, 355
 Oligarchies, 351
 Oligarchs own the government, 352
 Oligarchy replaces democracy, 350
 Oligonucleotides, 40
 Omar, Ilhan, 281
 Onshore winds, 66
 Open diplomacy, 351
 Optimum global population, 226
 Ordine Nuovo, 287

- Ordovician-Silurian Extinction, 317
Oreskes, Naomi, 104
Organic wastes, 77
Organized criminals, 201
Orgy of external cruelty, 260
Origin of life, 41
Orwell's dystopian prophesy, 352
Orwell, George, 352
OTEC, 73
Ottoman Empire, 152
Our children's future, 102
Our Common Future, 231
Our house is on fire, 57
Our leaders are behaving like children, 57
Overexploitation of ecosystems, 104
Overgrazing, 230
Overuse of pesticides, 238, 336
Oxygen, 60, 82
Ozone layer, 169, 172, 193
- Pacific Ocean, 79
Package of broadcasts, 328, 355
Packaging and retailing, 231
Pakistan, 170, 176, 227, 230
Pakistan's nuclear weapons, 201
Palade, George Emil, 33
Palestinians, 187
Palm oil production, 361
Paper industry, 76
Parabolic collector, 65
Paraguay, 69, 239
Paris Agreement, 55, 120, 272
Paris Climate Agreement, 180
Paris goals, 359
Paris temperature goals, 102
Party for Freedom, 252
Passionate about automobiles, 88
Pasturage, 227, 235
Patagonia, 253
Pathogenic bacteria, 15
Patriotism, 140
Paul Ehrlich, 172, 194
Pauling, Linus, 23, 30, 32
PCR technique, 41
Peace in Colombia, 180
Peak demand, 69
Peak solar power, 61
Pearl Harbor, 181
Pelamis Converter, 72
Pentagon Papers, 351
Pentagon's budget, 272
People themselves, 351
People's Party-Our Slovakia, 252
Peoples' Climate March, 104
Per capita energy use, 59, 62
Per capita food calories, 232
Permafrost melting, 249, 326
Permanent arms industry, 163
Permian extinction, 316
Permian-Triassic Extinction, 313, 317
Persecution of Christians, 157
Persistent organic pollutants, 340
Persson, Göran, 75
Perutz, Max, 31
Pesticides, 230, 238
Petroleum, 230
Petroleum price, 226
Petroleum reserves, 60
Petroleum-derived fertilizer, 340
Petrov, Stanislav, 198
Phagocytes, 15
Phagocytosis, 21
Phenylalanine, 37
Philippine Islands, 79
Phillips, D.C., 31
Photosynthesis, 74
Photovoltaic cells, 65
Photovoltaic efficiency, 61
Photovoltaic panels, 60
Photovoltaic production costs, 62
Photovoltaics, 66
Photovoltaics, cost of, 61
Photovoltaics, global market, 62
Physical properties, 199
Pile of corpses at Buchenwald, 264
Pimental, David, 231, 235

- Pipes, network, 65
Plans for blockade, 152
Plant diseases, 230
Plant energy, 232
Plant genetics, 227
Plasmids, 38, 237
Platinum electrodes, 82
Pledges remain unmet, 316
Plunder of our planet, 104
Plutonium, 168, 199–201
Pneumococci, 30
Poetry, 144
Poison gas, 147
Polish farmers killed by Germans, 264
Political influence, 163
Political instability, 180, 250
Politics of global warming, 124, 356
Politics of greed, 369
Pollination, 27
Pollination of crops, 104
Polymerase, 33
Polymerase Chain Reaction, 40
Polypeptides, 32
Pongamia pinnata, 76
Poor and most vulnerable, 317
Pope Francis I, 104, 365, 369
Population, 59
Population crash, 226
Population density, 61, 76, 226
Population extinction pulse, 319
Population genetics, 140
Population growth, 102, 230
Population growth and fossil fuel use, 224
Population growth and poverty, 239
Population losses and declines, 319
Population stabilization, 239
Populations displaced by war, 251
Populism in the US, 252
Portugal, 72
Position of genes, 29
Positive feedback loops, 320
Post-fossil-fuel era, 232, 238
Potentially irreversible threat, 55
Potsdam Institute, 317
Poverty, 104
Poverty alleviation, 317
Poverty generated by war, 188
Power reactors, 200
PR offensives, 365
Predatory delay, 358, 359
Preparation for war, 157
Prescott Bush, 155
President claims right to kill, 352
Pressley, Ayanna, 281
Preventable child deaths, 224
Preventable disease, 185
Preventable diseases, 186
Preventing an ecological apocalypse, 357
Price of petroleum, 226
Primary energy, 62
Primary fuels, 62
Primer, 40
Prioritizing basic human needs, 104
Private army, 263
Processing, 75
Project to destroy the Amazon, 283
Prokaryotes, 38
Proliferation risks, 200, 201
Proliferation, nuclear, 199, 201
Propaganda, 353
Propaganda and entertainment, 328, 355
Propeller-like design, 66
Protein chain, 33
Protein structure, 31
Protein-rich residues, 76
Protest gets louder, 104
Protons, 199
Prussian army officers, 144
Pseudospeciation, 143
Psychological effects of war, 186
Pu-239, 200, 202
Public education, 353
Public health, 185, 239
Public opinion, 199, 353
Public transport, 88

- Qaddafi, Muammar, 233
- R-factors, 38, 238
- R-type pneumococci, 30
- Rössler, Fritz, 287
- Rachel Carson, 330
- Racial cleansing, 147
- Racism, 259, 264, 286
- Racism is popular, 264
- Racism of Cecil Rhodes, 263
- Racist theories and atrocities, 260
- Radar, 167, 197
- Radiation sickness, 190
- Radical transformation, 56
- Radioactive fallout, 189, 198
- Radioactive graphite, 198
- Radioactive grass, 198
- Radioactive nuclei, 79
- Radioactive tracer techniques, 31
- Radioactive tracers, 33
- Radioactive uranium, 198
- Radioactive waste disposal, 199
- Rainfall, 61, 76, 230, 233
- Rank-determining fights, 136, 140
- Rape, 283
- Rapeseed, 75–77
- Rapeseed oil, 62, 74, 76
- Rapid and unprecedented changes, 55
- Rate of species loss, 319
- Ravings of capital city greenies, 104
- Raytheon, 177
- Rearmament, 157
- Recessive genes, 28
- Recombinant DNA, 38
- Recovery of the U.S., 263
- Red Dawn, 181
- Reduce military expenditure, 224
- Reduced consumption of meat, 253
- Reduced rainfall, 248
- Reflectors, 62
- Refrigerators, 65
- Refugee crisis, 250, 251
- Refugees, 187, 188, 224, 283
- Refugees from rising temperatures, 250
- Regional agreements, 317
- Regional Defense Strategy, 176
- Reichstag election, 1933, 157
- Religion and culture, 144
- Religion and ethnicity, 144
- Relocation of people, 69
- Renewable energy, 61, 68, 313
- Renewable energy infrastructure, 104
- Renewable energy policy network, 272
- Renewable energy systems, 82
- Renewable energy technology, 76
- Renewable natural gas, 77
- Renewables cheaper than fossil fuels, 97
- Reporting climate change, 353
- Reprocessing, 168
- Reprocessing fuel rods, 200
- Republican presidential candidates, 271
- Reserves of uranium, 200
- Reservoirs, 69
- Resource wars, 184
- Resources needed to manufacture cars, 88
- Restriction enzymes, 38
- Restriction maps, 38
- Revenge and counter-revenge, 165, 194, 203
- Revival of Nazi ideology, 286
- Rhodes' secret society, 263
- Rhodes, Cecil, 263
- Ribonucleic acid, 33
- Ribosomes, 33
- Richard Wilkinson's TED talk, 348
- Rift Valley, 79
- Right-wing parties, 157
- Righteousness, 139
- Rights of Indigenous peoples, 120
- Ring of Fire, 79
- Rise like lions, 353
- Rising energy prices, 62
- Rising temperatures, 248
- Risk management, 317
- Ritual scarification, 144
- Rituals, 144
- River deltas threatened, 249

- River of money, 163
 RNA, 33
 RNA and ribosomes, 33
 RNA polymerase, 33
 Robock, A., 169
 Rockefeller Foundation, 227
 Rockefeller Institute, 30, 33
 Rockwell, George Lincoln, 287
 Role of the media, 353
 Roma, 264
 Roman Catholic Church, 157
 Romer, Ernst, 286
 Roosevelt, Franklin D., 104
 Rosenfeld, Steven, 300
 Rothschild, Nathan, 263
 Roy, Arundhati, 184
 Royal Bank of Canada, 116
 Royal Institution, London, 31
 Royal Society of the UK, 104
 Russia, 79, 152, 168, 176, 198

 S-type pneumococci, 30
 Sacred duty, 139
 Saddam Hussein, 173
 Saddam Hussien's atrocities, 147
 Safe water, 186
 Sahel, 230
 Salination, 230, 236
 Salix viminalis, 75
 Salter's Duck, 72
 Salter, Stephan, 72
 Samsø 68
 Sanders, Bernie, 276, 371
 Sanders, Senator Bernie, 104, 272, 276
 Sanger, Frederick, 32, 39
 Sanitary water supply, 185
 Saturation pressure, 320
 Saudi Arabia, 233
 Saudi-backed forces, 248
 Saving the future, 56, 57
 Saving threatened species, 361
 Scandinavian countries, 272
 Scarce natural resources, 249

 Schoolstrike for climate action, 59
 Scientific evidence, 316
 Sea ice loss, 320
 Sea level rise, 249, 316, 326
 Secrecy versus democracy, 351, 352
 Secret diplomacy, 351
 Secret society, 263
 Secret treaties, 351
 Secret weapons development, 351
 Security Council, 174, 248
 Security threats, 251
 Seed, 232
 Selective breeding, 40
 Self-congratulatory mood, 260
 Self-destruction, 139
 Self-pollination, 27
 Self-sacrificing courage, 139
 Selfish motives, 139, 140
 Semiconducting materials, 60
 Sequencing methods, 32
 Sequestered carbon, 235
 Several hundred million deaths, 165, 195
 Severe droughts, 172, 193
 Shamanism, 143
 She's a fantastic money sink, 90
 Shell and Exxon knew, 124
 Shelley, 353
 Shiver, 139
 Short-rotation forests, 75
 Shortened food chain, 253
 Shrinivasa, Udishi, 76
 Siberia, 143, 253
 Siberian Traps, 318
 Sickle-cell anemia, 32
 Side chains, 15
 Side groups, 32
 Signed by 11,000 scientists, 104
 Silicon, 60
 Singapore, 239
 Single-stranded DNA, 31
 Sins against ecology, 104
 SIPRI, 177
 SIPRI Yearbook, 2017, 180

- Sir David Attenborough, 361
Sixth mass extinction, 319
Slandering scientists, 127
Slave laborers, 155
Sleeping sickness, 15
Slums, 239
Small arms, 174
Small arms, 639 million, 174
Smith, Dan, 180
Smith, Hamilton, 38
Smoke destroys health, 127
Snowden's revelations, 352
Snowden, Edward, 352
Social Darwinism, 263
Social Democrats, 157
Social disruption by war, 186
Social inequality, 230
Socialism, 272
Softening ethnic boundaries, 147
Soil erosion, 65, 230, 236
Solar City, 92
Solar constant, 74
Solar cooking, 60, 64, 65
Solar design in architecture, 60, 62
Solar energy, 60, 74, 76, 82
Solar heat collectors, 65
Solar parabolic troughs, 62
Solar thermal power, 60, 63
Solar water heating, 60, 65
Somalia, 173, 174
Somalia, famine, 248
Sonora 64, 227
Soot particles, 320
South Africa's nuclear weapons, 200, 201
South America, 79, 352
South Sudan, famine, 248
Southern Africa, 227
Southern Asia, 224, 227
Southwest Asia, 176
Sovereign states, 188
Soviet-style revolution, 157
Spain, 102
Spatial complementarity, 15
Spawning grounds, 69
Speak out in clear language, 57
Species, 143
Species loss, 319
Specificity, 15
Spent \$674 billion on new reserves, 125
Sperm cells, 29
Spiritual influence, 163
Stabilization of population, 253
Stable transgenic lines, 39
Staggering ignorance of Trump, 365
Staining cells, 15
Stanford University, 32
Start primer, 41
Starvation, 174, 185, 187, 259
Stein, Jill, 272
Stem cells, 39
Steric complementarity, 16
Stern Report, 230, 233, 235
Stern, Nicholas, 102
Sticky ends, 38
Stockholm Convention, 340
Stop primer, 41
Stop procrastinating, 369
Stop subsidizing fossil fuels, 272
Stop the expansion of extraction, 359
Storage batteries, 92
Storms of My Grandchildren, 372
Strasser, Otto, 287
Strategic competition, 180
Strikes, 104
Sub-Saharan Africa, 224
Subcellular particles, 33
Submarginal land, 227
Submission, 136
Subnational organizations, 201
Subsidies, 62, 272
Sudan, 173
Sugar beets, 74, 75
Sugar-phosphate backbone, 31
Sun-heated air, 65
Sunlight, 60, 61, 74
Superpower status, 176

- Survival, 142
 Survival of civilization, 184
 Swaminathan, M.S., 227
 Swamps, 77
 Sweden, 61, 75, 76, 198
 Sweden Democrats party, 252
 Swimming pools, heating, 65
 Symbols of power, 353
 Synthesis of proteins, 33
 Synthetic RNA, 33
 Syphilis, 15
 Syria, 173
 System of despotism, 263
 Systematic murder, 263

 Tamil Nadu OTEC station, 73
 Tanks, 154
 Tar sands oil, 117
 Target sequence, 41
 Targeted individuals, 184
 Tattoos, 144
 Tatum, Edward, 32
 Team-spirit, 140
 Technical defects, 167, 197
 Technology, transfer of, 239
 Tectonic plates, 79
 TED Talks, 348
 Television part of education, 353
 Television underestimated, 353
 Temperature and agriculture, 232
 Temperature inversion, 171, 193
 Template theory of immunity, 23
 Templates, 31
 Terminal transferase, 38
 Terrorism, 176
 Terrorism, nuclear, 168
 Tesla, 92
 Tesla Model 3, 92
 Thales Group, 177
 The 11th Hour, 369
 The 2016 US presidential election, 271
 The Big Picture, 371
 The Case for Optimism (TED), 361

 The climate emergency, 53
 The Geysers, 81
 The Great Transition, 100
 The Guardian, 54, 319, 353, 357, 361, 367
 The jaws of power, 350
 The Last Hours of Humanity, 371
 The Production Gap, 102
 The rules have to be changed, 57
 The science is clear, 104
 The Sea Around Us, 334
 The Silent Spring, 336
 The Telegraph, 263
 The Wind in the Willows, 330
 The world's 10 richest billionaires, 350
 Thermal buffer, 65
 Thermal conductivity, 79
 Thermodynamics, 73
 Thermohaline circulation, 326
 Thermonuclear bombs, 201
 Thermonuclear reactions, 203
 Thermonuclear war, 56, 135, 271
 Thermonuclear weapons, 140, 190
 Thermus aquaticus, 41
 Thirty Years' War, 154
 This car goes FAST, 90
 This report is my testimony, 104
 Thom Hartmann, 371
 Threat of large-scale famine, 224
 Threat of nuclear war, 190
 Threats and costs of war, 184, 185
 Three Gorges Dam, 69
 Three-letter code, 33
 Thunberg, Greta, 57, 365
 Thymine, 30
 Thymus gland, 23
 Thyroid cancer, 198
 Thyssen family, 154
 Thyssen, August, 154
 Thyssen, Fritz, 154, 156, 157
 Thyssen-controlled bank, 156
 Tidal level differences, 71
 Tidal power, 71
 Tidal stream, 71

- Tierra del Fuego, 79
Tinbergen, Nikolaas, 136
Tipping point, 313
Tipping points and feedback, 326
Tipping points, definition, 326
Tlaib, Rashida, 281
To control Soviet Union, 351
Tobacco and fossil fuel industries, 127
Tokyo, firebombing, 165, 195
Tom Cruse, 181
Too holy to be seen, 272
Toon, O., 169
Top Gear, 88, 359
Top Gun, 181
Topsoil, 235, 238
Topsoil, loss of, 230
Torture, 259, 263, 283
Total global supremacy, 176
Total reaction, 82
Trade unions, 157
Trading with the enemy, 155
Traditional rain patterns, 250
Traditional societies, 353
Transfer RNA, 33
Transgenic animals, 39
Transgenic organisms, 39
Transportation, 75, 231
Treaty of Versailles, 157
Trees, destruction of, 230
Trench warfare, 140
Triassic-Jurassic Extinction, 317
Tribal markings, 142–144
Tribalism, 139, 140, 142
Trillion-dollar elephant, 272
Triple Alliance, 152
Triple Entente, 152
Triumphant denialism, 359
Tropical cyclones, 316
Tropical rain forests, 227, 319
Tropical regions, 73
True-breeding plants, 27
Trump demonizes the Squad, 281
Trump elected on a racist platform, 270
Trump of the Tropics, 283
Trump rally supporting racism, 278
Trump, Donald, 55, 180, 252, 272, 300
Truthout, 54
TTAPS Study, 171, 193
Tumor-inducing plasmid, 39
Turbines, 71
Turco, R., 169
Turkey, 79, 230
Two billion risk starvation, 173
Typhoid fever, 239
U-235, 199
U-238, 199, 200
U-boats, 154
UK declares climate emergency, 53
Ukraine, 198
Ukrainian Neo-Nazis, 287
Ultra-deepwater oil, 117
Ultra-nationalists, 287
Ultracentrifugation, 31
Ultracentrifuges, 200, 201
Ultranationalism, 286
Ultraviolet spectroscopy, 31
UN Environmental Programme, 102
UN Framework Convention, 316
UN General Assembly, 165, 167, 195, 196
UN Security Council, 174
UN's Agenda 2030, 180
Unauthorized act, 168
Under the Sea Wind, 334
Undercover operations, 351
Unemployment, 239
Unenriched uranium, 190
Unequal distribution of incomes, 347
UNFCCC, 102
UNHCR, 249
UNICEF, 224
Union of Concerned Scientists, 56
United Kingdom, 152, 176
United Nations Charter, 188, 203
United States, 81, 152, 168, 176, 226, 230
United Technologies, 177

- Universal human brotherhood, 147
- Universality of religion, 144
- Unprecedented changes, 57
- Unprecedented heat waves, 316
- Unprecedented investment opportunity, 90
- Unsustainable human behavior, 88
- Unsustainable lifestyles in media, 359
- Unwarranted influence, 163
- Uranium, 199
- Uranium enrichment, 201
- Uranium reserves, 200
- Uranium-235, 190
- Urban expansion, 243
- Urban growth, 236
- Urban sprawl, 249
- Urbanization, 230, 239
- US Fish and Wildlife Service, 330
- US food system, 231
- US grain belt, 232
- USSR, 230

- Vacuum, partial, 65
- Value systems, 144
- Values from the mass media, 355
- Van Allen, James, 372
- Vapor pressure, 320
- Vast proportions, 163
- Vatican, 104
- Veils, 144
- Venice, 104
- Vertical shaft design, 66
- Viceroy Lord Lytton, 260
- Vicious circle, 157
- Vietnam, 189
- Vietnam War, 351
- Violence on television, 140
- Violent death, 187
- Violent team sports, 140
- Vitamin B12, 31
- Vlaamse Militanten Orde, 287
- Volatile liquid, 65
- Volcanic activity, 79
- Volcanic eruptions in Siberia, 318

- Volcanic regions, 79
- Volvo bans petroleum driven cars, 90
- Vries, Hugo de, 28

- Wales, 198
- Wali, Mohan, 232
- War, 174
- War as an institution, 163
- War in Syria, 251
- Warning from the World Bank, 316
- Warren, Elizabeth, 276
- Wars manufactured to sell weapons, 184
- Wars of religion, 147
- Washington Naval Treaty, 152
- Water, 82
- Water as a human right, 324
- Water availability, 230
- Water erosion, 235
- Water purification facilities, 188
- Water resources, 233
- Water scarcity, 316
- Water supplies, 230
- Water vapor a greenhouse gas, 320
- Water Watch, 324
- Water-heaters, 65
- Watson, James, 30
- Watson-Crick model, 31
- Wave energy, 72
- Wave farms, 72
- WCED, 231
- We are many, 353
- We love our cars, 88
- We want to protect you, 352
- We Were Soldiers, 181
- We will never stop fighting, 367
- Weapons of mass destruction, 140
- Weapons-usable materials, 200, 202
- Weapons-usable Pu-239, 200
- Weatherproof shell, 65
- Welfare, 317
- West African monsoon loss, 326
- Western Europe, 176
- Western hegemony, 352

- Wheat farms, 230
- Wheat varieties, 227
- Wheeler, John A., 199
- When at Times the Mob is Swayed, 300
- Whistleblowers, 352
- Wholesale deforestation, 286
- Wholesale electronic spying, 352
- Wilkins, Maurice, 30
- Wilkinson, Richard, 348
- Willing to die (and kill) for cars, 88
- Wilson, E.O., 140, 319
- Wind electrical power costs, 66
- Wind energy, 66, 76, 82
- Wind erosion, 230
- Wind parks, 66
- Wind power, 62, 68
- Wind turbines, 66, 67
- Wind velocity, 66
- Windmill parks, 68
- Winning slowly means losing, 359
- Wolfowitz Doctrine, 176
- Women held as hostages, 259
- Women, education for, 241
- Women, higher status for, 241
- Wood, 62, 65, 74, 75
- World arms spending, 185
- World Bank, 313, 316
- World Bank Group, 317
- World Bank warning, 316
- World Development Report, 316
- World domination, 263
- World Health Organization, 185
- World of Warcraft, 184
- World Scientists Warning, 104
- World Trade Center, 2001, 170
- World under British rule, 263
- World War I, 152, 154, 157, 351
- World War II, 154, 171, 188, 193
- World War II deaths, 264
- Worldwatch Institute, 100, 233

- X-ray diffraction, 30, 31
- X-rays, 29

- Xenophobia, 286
- Yemen, famine, 248
- Yields per hectare, 232
- Yongbion Research Center, 177
- Young population, 241
- YouTube, 359

- Zimbabwe, 174
- Zionism, 147