

International Campaign to Abolish Nuclear Weapons (ICAN)  
Global Harmony Association (GHA)  
Generation Hip Hop Global (GHHG)  
World Growth Forums (WGF)



## Anti-Nuclear Manifesto XXI

Gandhian peace spherons tetrad replacing genocidal nuclear triad



Mahatma Gandhi:

*Nonviolence [harmony of the spherons verified now by world statistics] is the greatest force at the disposal of mankind. It is mightier than the mightiest [nuclear] weapon of destruction.*

*Nonviolence [of the spherons] is the law of our life.*

Dedicated

To the Hiroshima/Nagasaki Victims 75<sup>th</sup> Anniversary

By

The ICAN/GHA 46 coauthors from the 26 countries

New Delhi  
2020

# The Manifesto Coauthors and Contributors

Presented on the GHA website personally: <https://peacefromharmony.org>

Nobel Peace Laureates, NGOs and Persons:

**Beatrice Fihn**  
Sweden



ICAN, CEO

**Mairead Maguire**  
Northern Ireland



Peacemaker

**John Avery**  
Denmark



Peacemaker

**Ernesto Kahan**  
Israel



Physician, IPPNW

**Setsuko Thurlow**  
Japan



ICAN member

**Leo Semashko**  
Russia



GHA Founder and  
Honorary President

**Ndaba Mandela**  
South Africa



Global Hip Hop,  
Mandela Institute

**Hasina Parvin**  
India



CEO, Editor-in-Chief  
World Growth Forums

**Norman Kurland**  
USA



Pres., Center for Economic  
and Social Justice

**Johan Galtung**  
Norway



Founder of peace and  
conflict studies

**Ayo Ayoola-Amale**  
Nigeria



GHA-Africa President,  
Lawyer

**Vladislav Krasnov**  
USA



GHA Vice President,  
RSGA President

**María C. Azcona**  
Argentina



GHA Vice President,  
Psychologist

**Uraz Baimuratov**  
Kazakhstan



GHA Vice President,  
Academician

**Stephen Amoah**  
Ghana



Statistician

**Noor Larik**  
Pakistan



GHA Vice President

**Guy Crequie**  
France



GHA Vice President

**Alfredo Sfeir-Younis**  
Chili



EVP, IAEWP

**Takis Ioannides**  
Greece



GHA Vice President

Anti-Nuclear\* Peace/Cyberspheronics Manifesto:  
The Noosphere Third Way XXI.  
(\*Anti-nuclear, only against nuclear weapons, no more)

Solidary anti-nuclear initiative of the world civil society  
Under the aegis of ICAN:  
International Campaign to Abolish Nuclear Weapons.

New Delhi  
2020



*“Nuclear weapons present an unacceptable danger to humanity. The only real way to eliminate the threat of nuclear weapons is to eliminate nuclear weapons...*

*75<sup>th</sup> Anniversary of the atomic bombings of Hiroshima and Nagasaki: time to end the nuclear menace.”*

**UN Secretary-General António Guterres**

*“No problem can be solved from the same level of consciousness that created it”.*

**Albert Einstein**

The UN has been talking about the elimination of nuclear weapons for 75 years on *“the same level”* of thinking, which created these weapons. Therefore, the escalation of a pathological policy for global confrontation between the nuclear powers within these years and this thinking has only accelerated the nuclear weapons race and expanded the nuclear threat scale to a suicidal global genocide/ecocide, which is only 100 seconds away according to experts. In order not to be held hostage of it for another 75 years, the UN needs to start looking for a common societal denominator, genetic code of the humanity survival and sustainable development in harmony, excluding the nuclear powers confrontation and ensuring their partnership, solidary building a scientific system of global security/peace. Its fundamental cybernetic foundation is revealed in the proposed **“Anti-Nuclear Manifesto”**. The beginning of this system construction should become **“World Survival Referendum”** in 2021 by the UN General Assembly decision, for members of which the ICAN and the GHA have prepared this **“Manifesto”**. The referendum will be a worthy start of the UN pressing/urgent system update, if it is intended to serve the humanity survival and sustainable development interests but not the pathological, deadly policy of global confrontation.

**ICAN and GHA**

**DEDICATED to the 75<sup>th</sup> anniversary of the 250 thousand civilian victims memory in the first nuclear genocidal terror of Hiroshima and Nagasaki on August 6 and 9, 1945, in order to exclude by the Global Security/Peace system of our Manifesto the very possibility of a repetition of similar crime against humanity in the future.**

**Leo Semashko, editor and 46 coauthors from 26 countries.  
Anti-Nuclear Peace/Cyberspheronics Manifesto:  
The Noosphere Third Way XXI.**

The GHA 78th project. Approved on June 21, 2020.

Published by Licorne International, New Delhi. 2020. – 100 p.  
ISBN 978-81-949473-0-1

The Gandhian “*Anti-Nuclear Manifesto*” first publication is Mahatma Gandhi’s homeland: India.

### **Abstract**

The Manifesto main conclusion:

Nuclear weapons are the mortal enemy of all peoples and every person, since the Hiroshima/Nagasaki nuclear Holocaust 1945. Nuclear weapons are a genocidal crime against humanity have not any justification.

The Manifesto main question:

Hiroshima/Nagasaki are 75. When do our Planet/Noosphere and us, the nuclear weapons hostages, expect their fate, if there are only 100 seconds left before it on the nuclear scientists Doomsday Clock (Mecklin, 2020)?

The Manifesto main response:

A stable ban and the eternal exclusion of nuclear weapons from the life of humankind is possible only on the fundamental scientific basis of Cyberspheronics, which ensures the consciousness and construction of a global security/peace system by the societal genetic Gandhian spherons, verified by world statistics and excluding violence, militarism and war.

## Authors

Beatrice Fihn, Mairead Maguire, John Avery, Ernesto Kahan, Leo Semashko, Francis A. Boyle, Ayo Ayoola-Amale, Pravat K. Dhal, Johan Galtung, Takis Ioannides, Olga Kashina, Michael D. Knox, Vladislav Krasnov, Norman Kurland, Bishnu Pathak, Lucas Pawlik, Maitreyee Roy, Théa Marie Robert, Bernard Scott, Rudolph Siebert, Alexander Semashko, Andrey Smirnov, Setsuko Thurlow, Robert M. Weir, Vladimir Onoprienko, Guy Crequie, María Cristina Azcona, Michael Ellis, Alexander Tonkonogov, Ashok Chakravarthy Tholana, Vera Popovich, Andrey Semashko, Bruce L. Cook, Heli Habyarimana, Stephen Amoah, Muhammad Zafar Iqbal, Noor Muhammad Larik, Uraz Baimuratov, Hasina Parvin, Ndaba Mandela, Terence Barry, Adam Greenwell, Alfredo Sfeir-Younis, Urbain Kapoko, Delasnieve Daspét, Anam Kumar,

### 46 coauthors from 26 countries:

Argentina, Australia, Austria, Brazil, Britain, Chili, Denmark, DR-Congo, France, Ghana, Greece, Israel, India, Kazakhstan, Japan, Nepal, New Zealand, Nigeria, Northern Ireland, Norway, Pakistan, Russia, Rwanda, South Africa, Sweden, USA,

**Editor-in-chief** is the GHA Founder and Honorary President, initiator and project manager Dr. **Leo Semashko**

### Authors by countries (on 05.11.20)

Argentina – 1	Denmark – 1	Israel – 1	New Zealand – 1	Russia – 8
Australia – 1	DR-Congo – 1	India – 5	Nigeria – 1	Rwanda – 1
Austria – 1	France – 2	Kazakhstan – 1	N/Ireland – 1	South Africa – 2
Brazil – 1 Britain – 1	Ghana – 1	Japan – 1	Norway – 1	Sweden – 1
Chili – 1	Greece – 1	Nepal – 1	Pakistan – 2	USA – 7

The GHA 78<sup>th</sup> project joint with the ICAN.

Started: May 17, 2020.

Approved on June 21, 2020.

The final version: December 05, 2020.

All previous versions of the “Anti-Nuclear Manifesto” disavow.  
The USA writer Robert Weir edited the main English text excluding the coauthors abstracts.

## **The Manifesto Architecture:**

Nobel Appeal. The Spherons Philosophy. Instead of a preface.

- I. World Survival Referendum on the “*Nuclear Weapons Prohibition*” Question
- II. Key Anti-nuclear Ideas of the Manifesto Authors
- III. Manifesto Definitions. Nuclear Weapons Prohibition and its Fundamental condition
- IV. Global Security/Peace (GSP). Existential Laws
- V. Cyberspheronics. The Societal GSP Science: Theory/Thinking
- VI. Cyberspheronics Pragmatics. The Best Global Security is Global Peace
- VII. ICAN/GHA Epilogue. Citizens of the Earth!
- VIII. Appendixes. “*The Anti-Nuclear Manifesto*” Final Formula.
- IX. Pragmatic Resume for the UN.  
Bibliography  
Contents

### **Nobel Appeal.**

We, the Nobel Peace Laureates (NGOs and persons),

Call the nations, governments, UN and Security Council to stop the 75 years world’s “*heading toward nuclear death*” **and to ban nuclear weapons by the relevant UN Treaty initiated by ICAN!** Can our reason, will, responsibility, humanism, conscience and human moral come to reconciliation with nuclear suicide, which has been generously funded by “*a seriously ill humanity*” during 75 years? How much money and attention we devote to the Covid-19 epidemic and how stingy and indifferent to the genocidal nuclear epidemic.

We call to re-prioritize the humanitarian threat of the two epidemics and to focus of political will, science and funding on banning nuclear weapons and joint building a global security/peace system. Banning nuclear weapons will free up significant investment to fight Covid-19, economic crisis and environmental catastrophe.

Our “*Anti-Nuclear Manifesto*” is the development and substantiation of the great legacy of global security/peace and “*new thinking*” of Mahatma Gandhi, Einstein, the IPPNW founders and others, whose ideas became prisoners in the 75-year-old Babel Tower of the military-industrial complex silence/oblivion. Banning nuclear weapons will change strategic, long-term priorities, liberate the peaceful legacy and free humanity from the genocidal weapons hostages in XXI century.

**Beatrice Fihn**, Executive Director of ICAN, NGO Nobel Laureate 2017,  
**Mairead Maguire**, Nobel Laureate 1976,  
**John Avery**, Nobel Laureate 1995,  
**Ernesto Kahan**, Vice President of IPPNW, NGO Nobel Laureate 1985.



---

Preparing nuclear weapons,  
“*we are already living in the rubble of World War III.*”  
*Nuclear weapons are all nations shared enemy.*”

Bernard Lown,  
1985 Nobel lecture

## **Spherons: The Survival Key and the New Intellect Substance.** **The Spherons Philosophy**

There is a cognitive law: **who knows the unknown, the impossible is available to him.** Our *Manifesto* knows the unknown holistic Gandhian spherons. Therefore, the impossible became available to its authors: a unique paradigm of *Global Security/Peace* (GSP) of the Gandhian nonviolence spherons was created in it. If 75 years ago, the UN and its Security Council would use the spherons Gandhian knowledge unknown to humanity, already then the impossible would have been available to them: the GBM system, which ensures nuclear and military zero. Then there would not have been the Hiroshima and Nagasaki Holocaust and the world would not have been immersed for 75 years in the hybrid/cold phase of the third world war, in the “ruins” of which, according to Lown, “*we already live*” now. Moreover, we have come close, by 100 seconds (Mecklin, 2020), to its hot and irrevocable for the survival of humanity/noosphere phase, to their death. **Why cannot the UN and governments realize and recognize this obvious suicidal trend of 75-year history and undertake/fund research of the unknown but salutary Gandhian knowledge of the spherons?**

History knows no subjunctive mood. But it leaves the future in full power of people, depending on their cognitive laws, the quality of knowledge, mind, collective intellect and will. Will we use, first, the UN and its SC, the Gandhian spherons new knowledge for a new, secure and peaceful future in our common home on Earth? **There is no other scientific alternative for survival and life in this house/noosphere.**

If, for the GSP system design, the UN and its SC cut off at least 0.1% (\$ 1.8 billion) of the total military spending on the development of its scientific knowledge, then the exit from the third world war ruins will not be long in coming. In 2-3 years, the foundations of Megascience, Architecture and Technology of the GSP system will be built as a new multipolar world order project and a way of survival in Einstein’s “*a substantially new manner of thinking*” by the Gandhian spherons. Do the UN and governments want a survival in peace and security? Or is it not required by them and impossible, inaccessible to their thinking/intellect? Impossible, because survival is not required; or is it not required because its new thinking is impossible for them?

The key to this globalist puzzle of the 21st century lies in the understanding of the substance of survival and its new intellect. Survival for humanity/noosphere can bring not artificial and natural intellect/thinking but only in the one case if it recognizes the Gandhian spherons as the substance of survival and follows their cognitive laws of peace and non-violence from the harmony of their societal equality. If it masters and rises to the highest, the holistic level according to Einstein of “*a substantially new manner of thinking*” by these spherons. **They are the key for survival and the substance for a new intellect, the knowledge of which (spherons) makes the impossible accessible always.**

GHA, the fundamental conclusion of solidary searching and working 15 years.

I. World Survival Referendum  
on the “*Nuclear Weapons Prohibition*” Question

Three years have passed since 122 countries supported the ICAN-initiated UN Treaty on the Prohibition of Nuclear Weapons (The Treaty, 2017). As one would expect, the nine nuclear countries that generally control the world order have resolutely refused to support it with one fundamental argument: we do not have any effective guarantees of national/global security and deterrence of a potential aggressor, other than nuclear weapons. Without their unanimous collective, without exception, approval of this treaty, such a position of ignoring it can continue indefinitely until the nuclear conflict destroys humanity along with its nuclear weapons in natural but catastrophic self-denial.

There is only one remedy other than global security/peace system (see below) that can overcome the situation of endless waiting and end nuclear weapons. That vehicle could be an extraordinary “**World Survival Referendum**” (WSR) with a question (for further editing):

***“Do you recognize as genocidal terror and a crime against humanity of any production, storage and use of nuclear weapons, starting with the atomic bombings of Hiroshima and Nagasaki in 1945 (250 thousand innocent civilian victims), requiring an immediate ban, only which will ensure the survival of “seriously [nuclear] ill humanity”? YES. NOT?”***

This is a “referendum of survival” for the following reasons, which were defined by the “International Physicians for the Prevention of Nuclear War” (IPPNW), 35 years ago, having made an accurate, still true, objective diagnosis of nuclear weapons and humanity, which has come to terms with their coexistence.

**Firstly**, nuclear weapons received from them in the 1985 Nobel Lectures an assessment of the global genocidal terror, which “***holding the entire world hostage, ... continuously targeted for extinction.***” Therefore, “***we physicians protest the outrage of holding the entire world hostage [by nuclear weapons]. We protest the moral obscenity that each of us is being continuously targeted for extinction.***” (Lown, 1985).

**Secondly**, humanity, which has come to terms with the coexistence of the global genocidal terror of nuclear weapons, generously finances its total suicide and is unable to find an alternative, non-suicidal way to ensure global security/peace, has turned out to be a “***seriously [nuclear] ill humanity***” that is steadily “***heading toward nuclear death.***” (Chazov, 1985).

**Third**, the IPPNW doctors’ “***medical recipe for human survival***” is as follows: “***To save it we must arouse the conscience of the world’s peoples, cultivate hatred for nuclear weapons, repudiate egoism and chauvinism, and create favorable atmosphere of trust. In the nuclear age, we are all interdependent. The Earth is our only common home, which we cannot abandon. The new suicidal situation calls for the new thinking.*** We must convince

those who take political decisions.” (Ibid). “**Substantially new thinking**” (Einstein) embodies our Manifesto.

The fundamental, effective way to “convince those who take political decisions” is a worldwide sociological referendum of survival to ban nuclear weapons with all its generally recognized negative attributes of “absolute evil, global terror, genocide and ecocide, weapons of a madman, suicide, burning alive, apocalyptic” and etc. Not only doctors, but all the victims of the atomic bombings of Hiroshima and Nagasaki, unequivocally qualify it during 75 years in this way (Fihn, 2017).

Another, complementary and developing, fundamental way of survival, prohibition and eradication of nuclear weapons lies in the solidary/partnership establishment of a scientific, cybernetic, self-regulatory system of global security/peace, to the justification of which is devoted the last two sections of our Anti-Nuclear Manifesto.

The ICAN, with almost 600 support organizations, will obviously be capable to organize a similar “**World Survival Referendum**” via the Internet in 6 UN languages in one way or another (for example, with the participation of minor children in it, for whom the parents would vote, or without them and etc.), sampling or continuous/massive sociological survey for 4–6 months.

II. The Manifesto Authors Key Antinuclear Ideas/Abstracts.  
(Many of them are the anti-nuclear NGO’s leaders)

**Leo Semashko, PhD,**

GHA Founder and Honorary President,  
“**Anti-Nuclear Manifesto**” Editor-in Chief, Russia,  
[https://peacefromharmony.org/?cat=en\\_c&key=253](https://peacefromharmony.org/?cat=en_c&key=253)

**“Nelson Mandela: South Africa’s Renunciation from Nuclear Weapons as Unprecedented Example of Gandhian Nonviolence.** South Africa is the first country in the world, which voluntarily renounced from nuclear weapons in 1989 under the influence of Nelson Mandela’s African National Union (ANC). Following an inspection by the International Atomic Energy Agency (IAEA) in August 1994, it confirmed that all nuclear weapons in South Africa had been disposed of. The election of Nelson Mandela this year as President of South Africa hastened and expanded the country’s anti-nuclear influence in Africa. In 1995, South Africa joined the Nuclear Suppliers Group, and in 1998, the Non-Aligned Movement, of which Nelson Mandela became President. The country played a pivotal role in signing the African Nuclear-Weapon-Free Zone Treaty (or the Pelindaba Treaty) in 1996 and joining it in 1997. In 1996, South Africa signed the Comprehensive Test Ban Treaty, ratifying it in 1999. All this was accelerated under the leadership of South African President Nelson Mandela. He underwent a great spiritual evolution of his conscious life from the violent communism and Marxist terrorism to the nonviolence of Gandhi, only on the base of which became possible the voluntarily renunciation from nuclear weapons. He became a great example of Gandhian nonviolence in both

*the non-violent overcoming of apartheid and the voluntary renunciation of nuclear weapons for all political leaders of the 21st century. Unfortunately, none of them supported the Nelson Mandela great example and now he is practically consigned to oblivion and has become the same spiritual dissident in the violent society like Mahatma Gandhi.*

*The international youth movement Generation Hip Hop Global (GHHG), created in South Africa, could to arm itself with the slogan of survival and liberation from terrorist nuclear weapons. It will be the most relevant for humankind and youth slogan, according to the legacy of Nelson Mandela: “**Youth demands a voluntary renunciation of nuclear weapons, following the example of Nelson Mandela’s South Africa!**” This slogan, embodied by the youth, will be the best monument and revival of his unique legacy of voluntary renunciation of nuclear weapons.”*

**Ndaba Mandela,**

Generation Hip Hop Global (GHHG), Chairman

Mandela Institute for Humanity, Founder, South Africa

[https://peacefromharmony.org/?cat=en\\_c&key=958](https://peacefromharmony.org/?cat=en_c&key=958)



*«The international youth movement GHHG: in solidarity with the GHA/ICAN. The need to pave the way to a safe and fertile future for our next generations is critical. In order to have a solid foundation for this growth, we need to address major global issues with a communal “voice of reason”. Nuclear power, not just weapons have become a major threat to humanity and the examples are clear in Chernobyl and Fukushima. The expenses incurred in all aspects of Nuclear power, let alone the constant threat, are a drain on society and not in our best interests. We have through history, as humanity,*

*failed to address our fundamental obligations to protect the planet and establish sustainable ideals to create a safe world for all.*

*Our obligation now, is to become effective, not just vocal in our denunciation and breathe new life into the protest though the introduction of strategic, cross sector partnerships. As Generation Hip Hop Global (GHHG), creating safe and sustainable environments for youth is our priority. This translates to our global drive as well and our support for a nuclear free world is absolute. We look forward to working with other organisations to expedite these ambitions.*

*The international youth movement GHHG, created in South Africa and in line with the legacy of Nelson Mandela, intends to continually educate youth on the destructive and devastating effects of nuclear weapons and will develop a slogan and campaign of solidarity with GHA/ICAN. It is according to the legacy of Nelson Mandela: “Education is the most powerful weapon with which to change the world.”*

**Ayo Ayoola-Amale,**

JD, MCI Arb, CMC, FIMC,

Jurist, Certified Conflict Resolution Consultant & Trainer, Nigeria,

[https://peacefromharmony.org/?cat=en\\_c&key=524](https://peacefromharmony.org/?cat=en_c&key=524)



***“Dr. Martin Luther King Jr’s: Nuclear Disarmament through “A Great Fellowship of Love”.*** King was a Civil Rights champion and nuclear disarmament activist whose desire was to see the world unite to work out their differences, to achieve peace and nuclear disarmament through what he called “a great fellowship of love.”

*He used his powerful voice for peace during the Cold War inspiring nations to eliminate all nuclear weapons with the urgent need. After 1945, the USA and the USSR were developing and testing nukes at a frightening speed. King ac-*

*knowledged that spending on nuclear weapons is stealing from society. He argued: **“A nation that continues year after year to spend more money on military defense than on programs of social uplift is approaching spiritual doom.”***

*He joined the National Committee for a Sane Nuclear Policy movement and also signed an appeal by Protestant clergy on halting nuclear tests and recognized that the stopping of the testing of nuclear weapons is a critical step toward stopping the arms race. King understood the threat of nuclear weapons and included a complete ban on nuclear weapons and their testing in the goals of achieving global peace. In 1957, King told Ebony Magazine, an African American owned publication that: **“I definitely feel that the development and use of nuclear weapons of war should be banned. It cannot be disputed that a full-scale nuclear war would be utterly catastrophic. Hundreds and millions of people would be killed outright by the blast and heat, and by the ionizing radiation produced at the instant of the explosion.”** In October 1958, King joined the US and Soviet negotiators in Geneva in a declaration to end nuclear testing.*

*But King’s thinking was planetary, humanistic, fundamental, far beyond the technical issues of banning nuclear weapons and their testing, it was of a universal scale. His Gandhian **“unarmed truth”** of this scale was **“that love is the only creative, redemptive, transforming power in the universe.”** Its source as **“the greatest force of humanity nonviolence”** at Gandhi is the Gandhian societal varnas/spherons. Only love and nonviolence of spherons are able to embody King’s urgent call, which is relevant, but utopian for traditional partial and militaristic thinking, **“to shift the arms race into a peace race.”** The reality of this call is revealed in **“a substantially new way of thinking”** (Einstein) by the Gandhian spherons in our **“Anti-Nuclear Manifesto”**. The knowledge of the spherons unknown to traditional thinking deployed in it ensures the achievement of King’s **“shift of the arms race into a peace race,”** which is impossible for it.*

*He contrasts the Gandhian love/nonviolence to the traditional violence: **“Violence is impractical because it is a descending spiral ending in destruction for all. It is immoral because it seeks to humiliate the opponent rather than win his understanding: it seeks to annihilate rather than convert. Violence is immoral because it thrives on hatred rather than love. It destroys community and makes brotherhood impossible. It leaves society in monologue***

**rather than dialogue. Violence ends up defeating itself. It creates bitterness in the survivors and brutality in the destroyers.** Therefore, King is firmly convinced **“that the principal objective of all nations must be the total abolition of war. War must be finally eliminated or the whole of mankind will be plunged into the abyss of annihilation.”** This goal can only be achieved by the Gandhian spherons and only by possessing the Gandhian knowledge of nonviolence deployed in our, Gandhian **Manifesto**.

**Beatrice Fihn,**

ICAN Executive Director, Sweden,  
ICAN is Nobel Peace Laureate 2017,  
[https://peacefromharmony.org/?cat=en\\_c&key=943](https://peacefromharmony.org/?cat=en_c&key=943)

*“At dozens of locations around the world – in missile silos buried in our earth, on submarines navigating through our oceans, and aboard planes flying high in our sky – lie **15,000 objects of humankind’s destruction**. Perhaps it is the enormity of this fact; perhaps it is the unimaginable scale of the consequences that leads many to simply accept this grim reality. To go about our daily lives with no thought to the instruments of insanity all around us. For it is insanity to allow ourselves to be ruled by these weapons.*

*Many critics of this movement suggest that ... **nuclear-armed states will never give up their weapons**. But we represent the **only rational choice**. ... Ours is the only reality that is possible. The alternative is unthinkable. The story of nuclear weapons will have an ending, and it is up to us what that ending will be. Will it be the end of nuclear weapons, or will it be the end of us? One of these things will happen. The only rational course of action is to cease living under the conditions where our mutual destruction is only one impulsive tantrum away...*

*These weapons were supposed to keep us free, but they deny us our freedoms. **It’s an affront to democracy to be ruled by these weapons... We citizens are living under the umbrella of its falsehoods**. These weapons are not keeping us safe, they are contaminating our land and water, poisoning our bodies and holding hostage our right to life.”*

Fihn B. (2017) International Campaign to Abolish Nuclear Weapons (ICAN). – Nobel Lecture:

**Setsuko Thurlow,**

ICAN member, Hibakusha, Japan,  
[https://peacefromharmony.org/?cat=en\\_c&key=953](https://peacefromharmony.org/?cat=en_c&key=953)

*“I speak as a member of the family of Hibakusha – those of us who, by some miraculous chance, survived the atomic bombings of Hiroshima and Nagasaki. **For more than seven decades, we have worked for the total abolition of nuclear weapons... We refused to sit idly in terror... We said: humanity and nuclear weapons cannot coexist**.*

*Today, I want you to feel in this hall the presence of all those who perished in Hiroshima and Nagasaki. I want you to feel, above and around us, a **great cloud of a quarter million souls...***

*I was just 13 years old when the United States dropped the first atomic bomb, on my city Hiroshima. I still vividly remember that morning. At 8:15, I saw a blinding bluish-white flash from the window. I remember having the sensation of floating in the air...*

Whenever I remember Hiroshima, the first image that comes to mind is of my four-year-old nephew, Eiji – his little body transformed into an unrecognizable melted chunk of flesh. He kept begging for water in a faint voice until his death released him from agony.

To me, he came to represent all the innocent children of the world, threatened as they are at this very moment by nuclear weapons. **Every second of every day, nuclear weapons endanger everyone we love and everything we hold dear.** We must not tolerate this insanity any longer... we must warn the world about these apocalyptic weapons.

But still some refused to see Hiroshima and Nagasaki **as atrocities – as war crimes.** They accepted the propaganda that these were “good bombs” that had ended a “just war”. It was this myth that led to **the disastrous nuclear arms race – a race that continues to this day.**

Nine nations still threaten to incinerate entire cities, to destroy life on earth, to make our beautiful world uninhabitable for future generations. The development of nuclear weapons signifies **not a country’s elevation to greatness, but its descent to the darkest depths of depravity.** These weapons are not a necessary evil; **they are the ultimate evil...**

All responsible leaders will sign this **Treaty on the Prohibition of Nuclear Weapons.** And history will judge harshly those who reject it. No longer shall their abstract theories mask the **genocidal reality of their practices.** No longer shall “deterrence” be viewed as anything but a deterrent to disarmament. No longer shall we live under a mushroom cloud of fear...

To every president and prime minister of every nation of the world, I beseech you: Join this treaty; forever eradicate the threat of nuclear annihilation.

When I was a 13-year-old girl, trapped in the shouldering rubble, I kept pushing. I kept moving toward the light. And I survived. Our light now is the ban treaty...

Tonight, as we march through the streets of Oslo with torches aflame, let us follow each other **out of the dark night of nuclear terror...** This is our passion and commitment for our one precious world to survive.”

Fihn B. (2017) International Campaign to Abolish Nuclear Weapons (ICAN). – Nobel Lecture:

**Francis A. Boyle, JD, PhD,**

Professor of International Law, USA

[https://peacefromharmony.org/?cat=en\\_c&key=957](https://peacefromharmony.org/?cat=en_c&key=957)

**“The Criminality of Nuclear Deterrence/Terrorism.** The human race stands on the verge of nuclear self-extinction as a species. The nuclear age was conceived in the original sins of Hiroshima and Nagasaki on August 6 and 9, 1945 (Boyle, 2013 and below). The atomic bombings of Hiroshima and Nagasaki constituted **crimes against humanity and war crimes** as defined by the Nuremberg Charter of August 8, 1945, and violated several basic provisions of the Regulations annexed to Hague Convention No. 4 Respecting the Laws and Customs of War on Land (1907). The nuclear weapons have never been legitimate instruments of state policy, but rather have always constituted illegitimate instrumentalities of internationally lawless and criminal behavior. The use of nuclear weapons in combat was, and still **is absolutely prohibited under all circumstances** by both conventional and customary international law. All government officials and military officers who might nevertheless launch or wage a nuclear war would be personally responsible for the commission of

Nuremberg crimes against peace, crimes against humanity, war crimes. Such individuals could thus be quite legitimately and most severely punished as war criminals, up to and including **the imposition of the death penalty**, without limitation of time.

**The threat to use nuclear weapons (i.e., nuclear deterrence/terrorism) constitutes ongoing international criminal activity. Four components of the threat to use nuclear weapons** that are especially reprehensible from an international law perspective: counter-ethnic targeting; counter-city targeting; first-strike weapons and contingency plans; and the first-use of nuclear weapons even to repel a conventional attack. Today's nuclear weapons establishments as well as the entire system of nuclear **deterrence/terrorism** currently practiced by all the nuclear weapon states **are criminal – not simply illegal, not simply immoral**, but criminal under well-established principles of international law. This simple idea of the criminality of nuclear weapons can be utilized to pierce through **the ideology of nuclearism** to which many citizens in the nuclear weapons states have succumbed.

It is with this simple idea of the criminality of nuclear weapons that concerned citizens can proceed to comprehend the inherent illegitimacy and fundamental lawlessness of the policies that their governments pursue in their names with respect to the maintenance and further development of nuclear weapons systems. **Humankind must abolish nuclear weapons before nuclear weapons abolish humankind.** The entire human race has been victimized by an international conspiracy of ongoing criminal activity carried out by the nuclear weapons states **under the doctrine known as “nuclear deterrence,” which is really a euphemism for “nuclear terrorism.”** This international criminal conspiracy of nuclear deterrence/terrorism currently practiced by the nuclear weapons states **is no different from any other conspiracy by a criminal gang or band. They are the outlaws.**

In light of the fact that nuclear weapons systems are prohibited, illegal, and criminal under all circumstances and for any reason, **every person around the world possesses a basic human right to be free from this criminal practice of nuclear deterrence/terrorism** and its concomitant specter of nuclear extinction. Every citizen of the world community **has both the right and the duty to oppose the existence of nuclear weapons systems** by whatever non-violent means are at his or her disposal. Otherwise, the human race will suffer the same fate as the dinosaurs, and the planet earth will become a radioactive wasteland. The fundamental intellectual means of nonviolent confrontation and resistance to nuclear weapons are focused in synergy by our international **“Anti-Nuclear Manifesto”** for the UN, governments and NGOs.”

**Mairead Maguire,**

Nobel Peace Prize Laureate, North Ireland,

[https://peacefromharmony.org/?cat=en\\_c&key=678](https://peacefromharmony.org/?cat=en_c&key=678)

**“Gandhi believed that humanity ‘possessed the greatest force of non-violence, love and peace’** and that it and each person are capable of using this force to change themselves and the world. In our violent world, after the atomic bombing of the Hiroshima and Nagasaki civilian population, militarism turned into murderous world state terrorism. For 75 years, its global system has taken humanity near to extinction and we have become a hostage on its nuclear scaffold of genocide and ecocide.

This anti-militarist Manifesto, based on love nonviolence harmony and peace offers an alternative to mainstream, dominant militarism. The Manifesto develops today a new scientific and peacemaking consciousness, which should to change the traditional, violent one through the practice of the Global Peace Science



as a third way for humanity. It is not too late to take this path of general and complete disarmament as the scientific alternative of nonkilling and peace.”

**Johan Galtung, PhD,**

Founder of peace and conflict studies, Norway,  
Director, Transcend International,

[https://peacefromharmony.org/?cat=en\\_c&key=599](https://peacefromharmony.org/?cat=en_c&key=599)

*“Militarism became world state terrorism in the United States, which launched it 75 years ago with the atomic bombings of Hiroshima and Nagasaki, retaining the right of a preventive nuclear strike. This keeps humanity in hostage of militarism, stops its humanistic evolution and threatens its survival during 75 years. Only the inevitable fall of militarism in general, and nuclear militarism first will save humanity from this threat and open the path of disarmament within global peace.”*

**John Avery, PhD,**

Nobel Peace Prize Laureate, Denmark,

[https://peacefromharmony.org/?cat=en\\_c&key=672](https://peacefromharmony.org/?cat=en_c&key=672)

*“If terror is recognized today as the most malicious inhumanity and crime against humanity, then nuclear weapons, undoubtedly, should be recognized as a potential, the highest degree of readiness in a few seconds, a global genocidal terror, unquenchable smoldering on alert at military bases, aircraft and submarines around the world. My book is devoted to this topic: **Nuclear Weapons: An Absolute Evil** (2017). The UN could have banned nuclear weapons long ago if it had been reformed according to the **“UN Harmony”** model created in the GHA in 2018 on the basis of cyberspheronics (global peace science) with my participation and presented in the Manifesto. Now, the proposed in it the solitary and intellectual consolidation of the world civil society under the ICAN auspices in the primary ban of nuclear weapons on a fundamental scientific basis, certainly deserves all-round support and implementation in creating an appropriate international laboratory for global security/peace. Readers may be interested in my book **“A World Federation”** (2018) with its chapter: **“Nuclear Weapons as Collective Punishment”** and others on this topic.”*

**Ernesto Kahan, MD,**

Professor, Physician, IPPNW Vice-President in 1985, Israel,

[https://peacefromharmony.org/?cat=en\\_c&key=338](https://peacefromharmony.org/?cat=en_c&key=338)



*“As a physician and Vice President of IPPNW in 1985, when our first anti-nuclear organization was awarded the Nobel Peace Prize, I fully share the Nobel Lectures’ assessment of nuclear weapons by two IPPNW leaders from the United States – Professor **Bernard Lown** and from the USSR – Professor **Yevgeny Chazov** as a global genocidal ter-*

*ror **“holding the entire world hostage”** and threatens everyone with **“continuously targeted for extinction.”**”(Lown, 1985). Indeed, being held its hostage is an **“outrage”** over humanity and **“moral obscenity”** towards every person as*

Professor Lown qualified them in 1985. Preparing nuclear weapons, in his ingenious opinion, “**we are already living in the rubble of World War III.**”

The need to completely ban this criminal, terrorist “**weapon of genocide**” became clear to us long ago, many decades ago. But its fundamental scientific substantiation in the context of global security and peace, only in which it can be fully implemented, quickly and by all countries, without fruitless ten-year expectations, unfortunately, still does not exist.

For over 15 years, the GHA has been developing a scientific non-violent system of global security/peace, presented in its 10 books, especially in **Global Peace Science** (2016) and **Gandhica** (2019) with my participation. The proposed Peace/Cyberspheronics Manifesto, with its Third, non-violent Way of human evolution, compressed their content up to 20 pages, is a powerful contribution and support for the ICAN Treaty on the Prohibition of Nuclear Weapons. This is a worthy, fundamental and humanistic scientific initiative of the GHA, which sees the invisible – the Gandhian spherons of non-violence.

Professor Lown argued in his Nobel Lecture “**Only those who see the invisible can do the impossible.**” Therefore, the GHA offers a Manifesto for a non-violent global security/peace system, which seems impossible in a militaristic age. As a physician, I cannot stay away from this Manifesto, which deals with the preservation of the life of people and humanity as a whole. This is in line with IPPNW’s updated Hippocratic Oath calling on doctors to fight nuclear weapons as the common enemy of humanity.”

### **Norman Kurland, JD,**

President, Center for Economic and Social Justice, USA, [thirdway@cesj.org](mailto:thirdway@cesj.org),  
[https://peacefromharmony.org/?cat=en\\_c&key=414](https://peacefromharmony.org/?cat=en_c&key=414)

“The elimination of nuclear weapons, as well as complete/general disarmament, by and large, are impossible without a fundamentally substantiated common and holistic scientific platform/theory of the “**Global Security/Peace**” system. But this system will face very tough but fair fundamental requirements, one of which is to ensure global economic equality and economic property rights for every person. Their well-founded theory and convincing practice over several decades in the United States was presented in the works of Kelso (1958, 1968), Kurland (1982, 2014, etc.) and many of their followers. This theory allows us to answer the question: After the COVID-19 pandemic war, how can we unite to build a more just future for every world citizen?”

Louis O. Kelso, universal citizen ownership and binary economic theorist and author, inventor of Employee Stock Ownership Plans (ESOPs), and a globally-respected lawyer-investment banker, observed that money is a “yardstick,” i.e., a symbolic means for measuring “economic input, economic outtake and the relative values of the real goods and services of the economic world.” Equal access to money and power over the central banking system would allow every person to become economically and politically-free property-owners, without violating property rights of current owners of their current assets.

Instead of the State controlling the money system, under the proposed Capital Homestead Act, every citizen (or their parent or guardian) would have an equal opportunity to own growth voting shares in well-managed enterprises, as well as local bank members of regional and global central banks. Under the proposed the Capital Homestead Act, as each person becomes increasingly empowered to make independent family, educational, spiritual, health, social, and political choices, the

State itself would become economically dependent on all citizens. This would reverse the ever-increasing and dangerous economic dependency of property-less voters throughout the world on those who control the monopoly powers of the State.

This would turn today's non-owners into economically independent owners of productive capital. Such credit would finance the purchase of new or existing productive assets needed by businesses. Future earnings on the shares would pay off the acquisition loans – in other words, using “future savings” rather than “past savings” or reductions of current consumption income to repay the capital credit. These are the key attributes of Kelso/Kurland's binary economy and economic equality

In conclusion, we should emphasize that without the perspective of similar economic equality in synergy with other holistic requirements, a ban on nuclear weapons, general/complete disarmament, global security/peace and survival, like other holistic potentials of the **“Just/Spherical Third Way”** systematically presented in our **Antinuclear Peace/Cyberspheronics Manifesto** (# 14.1.) are unlikely to be possible.”

**Pravat Kumar Dhal, PhD.,**

Professor and Head, Department of Education, Magadh University, Bodhgaya, India  
[https://peacefromharmony.org/?cat=en\\_c&key=890](https://peacefromharmony.org/?cat=en_c&key=890)

“The fundamental scientific merit of the **Peace/Cyberspheronics Manifesto** and its unique system of global security/peace, excluding all weapons, including nuclear ones, lies in their support and development of the key Gandhian idea of societal varnas/spherons. They, according to Gandhi, define the existential law of **“non-violence as the greatest force of mankind, more powerful than the most destructive nuclear weapons.”** The GHA special book, which received the short name “Gandhica” (Semashko, 2019), created by the GHA 82 co-authors from 25 countries and published in four languages, is devoted to a detailed analysis and large-scale global statistical substantiation of the law of spherons nonviolence. This book contains the rationale and development of the GHA “Global Peace Science” (2016), in which the model of the global security/peace system based on spherons was first presented.

Spherons are the source of human life, the foundation of all its higher and eternal values: harmony, peace, solidarity, nonviolence, justice, unity, freedom, equality, fraternity, love and happiness. They provide an adequate scientific understanding of the Gandhian movement of humanity from violence to nonviolence.

Discovered in India, they will form the societal foundation of a new, non-violent world order, according to Gandhi's firm conviction, which he repeated many times but the West ignored it. Therefore, we with good reason assert that without spherons, without recognition, development and key application of this fundamental idea, global security/peace will never take place, therefore, there will never be disarmament and an unconditional ban on nuclear weapons.

The **Peace/Cyberspheronics Manifesto** is just a synopsis of “Gandhica”, without a deep study of which it is impossible to fully understand this Manifesto and its system of global security/peace, excluding nuclear weapons, as well as violence/militarism in general. Without assimilating this book, the modern, scientific, peaceful and effective education of children and youth, its anti-nuclear and anti-militaristic upbringing in the spirit of Gandhian non-violence, widely practiced in India, including our university, is impossible.”

**Andrey Smirnov, PhD.,**

The Head of the “Novgorod Thought-Technical School O.S. Anisimov”, Russia,  
[https://peacefromharmony.org/?cat=ru\\_c&key=813](https://peacefromharmony.org/?cat=ru_c&key=813)

*“Our transitional era, overloaded with nuclear weapons and violence of all types and colors, accompanied by a crisis of the very foundations of civilization, needs a fundamentally new ideology, new thinking and new strategic projects.*

*In our opinion, such a breakthrough ideology, thinking and project found their fullest expression in the **Peace/Cyberspheronics Manifesto**, which can be recognized as the first scientific strategic project to rid humanity from nuclear weapons in the context of the global security/peace system. The fundamental novelty of this project lies in the fact that not one area of human life is taken as the object of research, but the universal societal integrity of four spheres/spherons of the noosphere in unity with the biosphere and cosmos that allows building a comprehensive model, which excludes all sources and means of nuclear weapons.*

*Cyberspheronics, as a metasystem approach, is most adequate to a holistic solution of the most important goal for the 21<sup>st</sup> century: the survival of humanity and the salvation of the bio- and noosphere from global nuclear ecocide/genocide. It is the way out of the civilization crisis along the Third Way (outside of capitalism/communism) to harmonize of the coexistence of different civilizations on the basis of their societally/genetically equal spheres/spherons. To solve it, this science creates a number of unique technologies. They are technologies of unified spherical statistics for all countries, technologies for creating a spherical Internet, technologies for a digital platform of a new, non-violent democracy, technologies for solving global environmental and economic problems, technologies for smartphone applications, and the like, capable of holistically control, prevent and suppress all possible sources of nuclear weapons.”*

**Vladislav Krasnov, Ph.D., historian, anthropologist,**

President of the Russian-American Goodwill Association, RAGA, [www.raga.org](http://www.raga.org), USA,  
[https://peacefromharmony.org/?cat=en\\_c&key=752](https://peacefromharmony.org/?cat=en_c&key=752)

*“The need for nuclear disarmament has always been recognized by the leaders of the United States and Russia, the two powers possessing 95% of their nuclear potential. At one time, the USSR responded to US atomic strikes against Japan with its own nuclear arms race. The Soviet leaders justified this with the Marxist-Leninist ideology of irreconcilability with capitalism, which supposedly inevitably degenerates into imperialism. But even during the apogee of communism in the 1980s, US President Ronald Reagan and Soviet President Mikhail Gorbachev made significant progress in curbing the nuclear arms race. Awareness of the growing risk of nuclear war forced them to abandon ideological schemes for a pragmatic goal: the survival of their own countries—and of life on Earth!*

*Since 1992, our peacekeeping organization of Goodwill between the United States and the new, post-communist Russia ([www.RAGA.org](http://www.RAGA.org)) has been looking for every opportunity to control nuclear weapons up to their complete ban on the entire planet. That is why we joined the coalition of the Global Harmony Association (GHA). Alas, now the whole world is on the edge of the abyss.*

*The “**Peace/Cyberspheronics Manifesto**” (30 pages), created in the GHA, is the Manifesto of Gandhian Non-Violence. Denying all violence, it demands the prohibition of nuclear weapons and poses a historical question: Will former ideo-*

logical opponents be able to find common ground in eliminating this mutually deadly weapon? The same question I asked in my 2019 article: "**Mahatma Gandhi and Aleksandr Solzhenitsyn...**"

If some 35 years ago the USA and the USSR had a modicum of mutual trust, today it is practically nonexistent. All past international restrictions on nuclear weapons have been dismantled, opening a new race for Weapons of Mass Destruction. She brought humanity as close as possible to a nuclear disaster. According to nuclear scientists (Mecklin, 2020), there are only 100 seconds left. It is time to understand the salutary role of our **Peace/Cyberspheronics Manifesto**, with its focus on global security.

Only mutual concessions between the United States and Russia can restore trust, ensure good political will on both sides, and revive the atmosphere of cooperation that existed under Reagan and Gorbachev. Otherwise, the risk of nuclear war will grow like a snowball until it buries everyone under its avalanche. It is the will of every citizen that determines the shift towards cooperation that this Manifesto breathes. Our optimal goal: Voluntary mutual renunciation of nuclear weapons and their complete ban in all countries in the coming years.

It needs to be stressed that our efforts toward nuclear disarmament can hardly be successful unless we also strive for social, ethnic, racial, and religious harmony and justice in each and every nation and the world. We should work in coalition and synergy with other holistic movements, such as "The Third Way" economics formulated by Louis Kelso and his successor Norman Kurland. For building a coalition we should be guided by Mahatma Gandhi's advice: "**The Satyagrahi's goal is to convert, not to coerce, the one who disagrees.**"

### **Alexander Semashko,**

Economist and businessman, Russia

"The Peace/Cyberspheronics Manifesto is a program for broad and long-term action, including the prohibition and prevention of nuclear weapons, hostile to each person and humanity as a whole. Therefore, by and large, every person who wants to live is vitally interested in this program. The ideas and principles of this scientific program are clearly reflected in Cyberspheronics and do not raise doubts. But from the point of view of stylistics, this program/manifesto, as a public document, should be understandable to everyone, starting with a student. Now it looks more like a scientific treatise and an appeal to the scientific world and does not cling to the soul of ordinary people. To do this, it must find another form and become a call, be a cry or an alarm, if you like – a rap that will be understandable to any young human and wake everyone up. This manifesto must find an individual dimension. It should reflect the interests of each sphere as the quintessence of every social person, aimed at love, peace, harmony, justice and equality with other people, and therefore excluding violence and weapons, especially genocidal, nuclear, intended to destroy entire nations and humanity as a whole. It is difficult and delicate, at the same time artistic, unique work that takes a lot of time, but it is necessary and inevitable. We must grow in this direction. Our path is thorny, but we will not retreat. The most important thing is that we have a foundation – a spherical approach, on the basis of which we can build any harmonious building for any purpose, including the liberation of our common home from the cancer pathology of nuclear weapons."

**Robert Weir,**

Author, speaker and advocate for 'peace through understanding', USA,  
[https://peacefromharmony.org/?cat=en\\_c&key=239](https://peacefromharmony.org/?cat=en_c&key=239)

*"The development, manufacture, and proliferation of nuclear weapons has been (along with climate change) one of the most acute and urgent problems of every nation on Earth since the United States of America dropped atom bombs on Hiroshima and Nagasaki, Japan, 75 years ago. For three-quarters of a century, nuclear weapons have been—and are—the greatest threat to humanity as well as global ecology and economy. Unless disarmed and outlawed by all nations, the potential for nuclear destruction will continue into the unforeseeable future.*

*However, eliminating the potential for another Hiroshima/Nagasaki nuclear holocaust requires not only speeches, journalistic editorials, or even massive protest campaigns. Elimination of warfare materiel starts with a shift in thinking by government leaders who are willing to set aside their personal profiteering agendas and, instead, adopt a paradigm of universal peace.*

*This paradigm of peace could then lead to the establishment of formal peace institutions by national governments and world organizations in which the top elected and appointed leaders would listen to and accept the advice of experts educated in the methods of diffusing conflict and creating harmonious international relationships ... by means of discussion, dialogue, diplomacy, and détente rather than brute military force.*

*In the United States in 1793, Benjamin Rush, an American physician, civic leader, humanitarian, educator, and a signer of the US Declaration of Independence, wrote an essay titled "A Plan of a Peace-Office for the United States." Rush proposed that this Peace-Office would be created as a department within the United States Cabinet, which serves as the top advisory council within the executive branch of the US federal government; it would be headed by a Secretary of Peace. Thus, the Peace-Office would be on an equal footing with the US Department of War (now called Department of Defense), which the new government had already established on August 7, 1789.*

*Rush wrote that the purpose of this proposed Peace-Office would be to **"promote and preserve perpetual peace in the United States."** Its primary responsibility would be **"to inspire a veneration for human life, and a horror at the shedding of blood."** It would advocate that **"to subdue that passion for war ... militia laws should everywhere be repealed, and the military dresses and military titles should be laid aside."** (Source: [https://en.wikipedia.org/wiki/Department\\_of\\_Peace](https://en.wikipedia.org/wiki/Department_of_Peace))*

*Unfortunately, Rush's concept failed to attain passage by the United States Congress—as was also the case for measures that would have abolished slavery and granted the right to vote to women.*

*In the 20<sup>th</sup> century, various peace advocates in the US have attempted to legislate the establishment of a Cabinet-level Department of Peace (DoP)—most prominently in the 1920s through the 1970s and again in the early 21<sup>st</sup> century, but to no avail.*

*Currently, the creation of a US Department of Peace is being addressed by the Peace Alliance and the Student Peace Alliance. Both are national nonpartisan nonprofit organizations that support independent grassroots political movements. From 2006 to 2009, I was the chair of the DoP chapter in Southwest Michigan. Try as we may, we could not convince our local Congressional representative to support the legislation introduced by Rep. Kucinich.*

The concept of a Department of Peace is mentioned in the Global Harmony Association's (GHA) "**Peace/Cyberspheronics Manifesto**." As a world civil society with a long-term roadmap for prohibition, control, and prevention of nuclear weapons, ICAN is in a position to be the prototypical model for respective national and international government bodies to establish a Department of Peace in the future. Creation of a Peace Department or a Peace Office within ICAN will be one way for ICAN, working with a fundamental scientific platform within the world's international societal laboratory, to achieve its goal, as proposed in our Manifesto.

As an advocate of the concept of "peace through understanding," I hope that ICAN is successful in this endeavor."

**Rudolf Siebert, PhD,**

Professor of Religion and Society, Department of Comparative Religion,  
Western Michigan University, Michigan, USA

[https://peacefromharmony.org/?cat=en\\_c&key=51](https://peacefromharmony.org/?cat=en_c&key=51)

"The ICAN remarkable initiative to ban nuclear weapons, supported by many countries and our "**Peace/Cyberspheronics Manifesto**" within the framework of the "**Just/Spheral Third Way**" can and should seek a religious dimension. First of all, it can be broad support of world religions and believers of all confessions, which clearly express their peacemaking and anti-nuclear orientation. I analyze this perspective in more detail in my recent article "**The Third Way**", written for our Manifesto (Siebert, 2020)."

**Bishnu Pathak, PhD,**

Professor, Commission of Investigation on Enforced Disappeared Persons, Nepal,

[https://peacefromharmony.org/?cat=en\\_c&key=910](https://peacefromharmony.org/?cat=en_c&key=910)

"The main merit and the greatest force of non-violence against genocidal nuclear weapons of our "**Peace/Cyberspheronics Manifesto**" lies in its "essentially new way of thinking" (Einstein) by the Gandhian spheres/spherons. Its technology, foundations, details and procedures are disclosed in the book, which is basic for the Manifesto – GHA "**Gandhica**" (2019, 240 pages). As you know, attempts to solve problems with traditional thinking are unsuccessful. This law of thought was formulated by Einstein, when he wrote 70 years ago that any fundamental problem "**cannot be solved at the same level of thinking at which we created it.**" To solve them, a "substantially new way of thinking of humankind" by spheres and spherons is needed, which is presented in the GHA 10 books for 15 years of its work and is condensed, on 20 pages, expressed in our Manifesto. Only spherons exclude violence, war, weapons, including nuclear deals. According to Gandhi's definition, they constitute the first law of human life. Therefore, without studying the Gandhian thinking by spherons, it will hardly be possible in ICAN to understand the proposed Manifesto in order to effectively use it to deeply address the issue of banning nuclear weapons in the context of the global security/peace system. To master new, spheral peacemaking thinking, ICAN could organize a special seminar and a school of "Gandhian literacy", in which the Manifesto thinking could be studied along with its basic textbooks: "**Gandhica**" (2019) and "**Global Peace Science**" (2016) and "**The ABC of Harmony**" (2012). This would be the most fundamental ICAN preparation for the achievement and implementation of a nuclear ban."

**Lucas Pawlik, PhD,**

Cybernetician, Ecologist and Therapist, Austria,

[https://peacefromharmony.org/?cat=en\\_c&key=887](https://peacefromharmony.org/?cat=en_c&key=887)

*“Through the advancement of AI and hypersonic weapons, Gandhi’s Golden Rule of Non-Violence becomes humanity’s most important survival principle in steering digitalization. We either non-violently hack humanity’s digitally empowered circle of violence or die from its escalation.*

*My contribution as cybernetician to the **Peace/Cyberspheronics Manifesto**, which will be used as an intellectual instrument for prohibiting nuclear weapons, is the brief essay of my fundamental ideas in **“The Conclusion of Gandhica”** (2019). My essay is based on a synthesis of the ideas of my teacher and friend Heinz von Foerster and Gandhi’s Golden Rule of Nonviolence. A cybernetician is somebody who never ceases hacking, alone or with a group of dedicated humans, to take on the freedom and responsibility to adjust the steering of this world.*

*The key idea of my essay is that in the **Gandhica and the Manifesto** we have prepared a “hacking”/change of partial, militaristic, nuclear cybernetics, providing control and supersonic delivery of nuclear weapons along with the corresponding digitalization, by holistic, non-violent, humanistic cybernetics of the Gandhian spheres/spherons with appropriate digitalization based on holistic spherical statistics deployed in Gandhica. Only as a result of similar hacking/change we can expect not only a ban, but also a complete exclusion of nuclear weapons from the evolution of humankind. The Gandhian nonviolent cybernetics disclosed in our texts – cyberspheronics and the corresponding statistical digitalization, which ensure the creation of a nonviolent system of global security/peace, is the hacking/replacement of militaristic violent cybernetics and the digitalization of supersonic nuclear bombs/missiles, which have completely prepared the inevitable nuclear ecocide/genocide for humanity and the biosphere. It’s only a matter of time and reason.*

*The absolutely humanistic goal of banning nuclear weapons requires the ICAN to be equipped with the most effective tools for their destruction from the inside and prevention from the outside, which are offered by the Gandhian cyberspheronics and its spherical digitalization in our **Manifesto**. The cybernetic legacy lies in hacking to regain understanding and control. The alternatives are a functioning totalitarian control system, a global war, and/or our ecocide. The engineers have already hacked our world. We perpetuate the war and compete to increase the production of weapons and control them, while the main task of humanity is the non-violent self-organization of its life on the basis of its societal genetic spherons, as Gandhi predicted.*

*Like those cyberneticians fleeing the Second World War, uniting from all over the world united, humanity needs to unite now to solve the task of digitalization: how to unite human and machine intelligence as our **Manifesto** suggests. We either imagine and act on a common non-violent solution, or soon any moment of humanity’s digital transformation, even without human interference, could be our last.*

*My conclusion. Today we need a new BCL-like research and learning labs, as our **Manifesto** suggests, through which we can take on the responsibility to re-design our evolution, to steer our from our impending collapse into our future through and beyond traditional digitalization. It will be a non-violent Gandhian breakthrough of a qualitatively new information and social Era with “a substantially new manner of thinking” by spheres/spherons.”*



**Olga Kashina, PhD,**

Statistician and economist, Russia,

[https://peacefromharmony.org/?cat=ru\\_c&key=757](https://peacefromharmony.org/?cat=ru_c&key=757)

*"Peace and anti-nuclear movements are weak because they lack effective scientific instruments. For 15 years of work, the GHA was able to create several similar tools, the most effective and promising of which is fundamentally innovative spherical statistics in its most relevant part of spherical statistics of spherons. Its incomparable advantage is its holistic, universal/global scale based on the logic of thinking from the whole to its spherical parts. Traditional statistics do not know anything like this in its thinking, so it remain partial, nationally limited, torn/fragmented and devoid of integrity/wholeness. Therefore, it is far from scientific, objectivity, often acts as a tool for manipulation and is by than the third: **"truth, lies and statistics."** Spherical statistics of spherons orders and organizes traditional statistics into a fundamentally new tool for knowledge and governance. It is substantiated by the world statistics of 76 countries represented in **Gandhica** (2019) and constitutes the irrefutable empirical foundation of the humanity spherons at all its levels from the individual, family, school to the region, country and the world as a whole. In this capacity, spherical statistics is the most effective quantitative and mathematically (mathematical statistics, matrix algebra, fractal mathematics, etc.) armed digital instrument of the **"Global Security/Peace"** system, which constitutes the main positive content of our **"Manifesto of Peace / Cyberspheronics"** and the most fundamental scientific alternative to nuclear weapons, as well as militarism in general. Therefore, ICAN cannot do in achieving its goal of banning nuclear weapons without spherical statistics in general, spherons in particular that I firmly declare on the basis of all my life and scientific experience as a professional statistician. But for the development of spherical statistics, ICAN needs to create an appropriate funded scientific institute or laboratory, organizationally and scientifically independent from the institutes of traditional statistics but using it and cooperating with it that is unfolded in our Manifesto."*

**Maitreyee Roy, PhD,**

Sociologist, Cybernetician, India,

[https://peacefromharmony.org/?cat=en\\_c&key=481](https://peacefromharmony.org/?cat=en_c&key=481)

*"While referring to our **"Manifesto of Peace/Cyberspheronics"**, I would prefer to rely on Gandhi only. Hence I prefer to add the gist of Gandhi's reaction and his agony score, when he learnt about the discovery of the nuclear weapon, to quote his own expression in his own words.*

*There have been cataclysmic changes in the world. Do I still adhere to my faith in truth and nonviolence? Has not the atom exploded that faith? Not only has it not done so but it has clearly demonstrated to me that the twins constitute the mightiest force in the world. Before it, the atom bomb is of no effect. The two opposing forces are wholly different in kind the one moral and spiritual, the other physical and material. The one [truth] is infinitely superior to the other, which by its very nature has an end. The force of the spirit is very progressive and endless. Its full expression makes it unconquerable in the world. In saying this, I know that I have said nothing new. I merely bear witness to the fact. What is more, that force resides in everybody, man woman, and child, irrespective of the colour of the skin. Only in many, it lies dormant, but it is capable of being awakened by judicious training.*

*It is further observed that without the recognition of this truth and due effort to realise it, there is no escape from self-destruction. The remedy lies in every*

*individual training himself for self-expression in every walk of life, irrespective of response by the neighbours. ... You cannot successfully fight them with their own weapons. After all, you cannot go beyond the atom bomb. Unless we can have a new way of fighting imperialism of all brands in place of the outworn one of a violent rising, there is no hope for the oppressed races of the earth.”(Gandhi, 1982, 1998, 2014). “The weapon of violence, even if it is the atom bomb, becomes useless when it is matched against true non-violence.” (Gandhi, 1946)*

*About Gandhi not without reason say: **“Some men changed their times... One man changed the World for all times!”***

**Ayo Ayoola-Amale, JD, MCI Arb, CMC, FIMC,**

Jurist, Certified Conflict Resolution Consultant & Trainer, Nigeria,

[https://peacefromharmony.org/?cat=en\\_c&key=524](https://peacefromharmony.org/?cat=en_c&key=524)

*“Humanity stands at the crossroads of whether to save itself, other living things and the planet from self-destruction through the insanity of nuclear weapons proliferation. The world’s women and Children bear enormous burdens in times of conflicts and war. They are staunch opponents of nuclear weapons and supporters of their prohibition. Women and children, on average, make up about 70% of the population. Consequently, the scale of its demographic influence and population weight with regards to the gender/child dimension of the prohibition of nuclear weapons. Similarly, the importance of this dimension in the positive support of the **“Global Security/Peace”** system acknowledged in our **“Peace/Cyberspheronics Manifesto”**. Hence, gender is a main concern for The International Campaign to Abolish Nuclear Weapons (ICAN). And for us, as leaders of the international Women GHA ([https://peacefromharmony.org/?cat=en\\_c&key=815](https://peacefromharmony.org/?cat=en_c&key=815)).*

*When the two atomic bombs dropped on August, 1945 by the US forces completely destroyed Hiroshima and Nagasaki on the spot, killed and wounded hundreds of thousands of people devoid of discrimination, it not only brought total human violence to the environment but it was a volcanic eruption on souls, spirits and generations unborn. For over 70 years those who barely ‘survived’ have struggled to live on, afflicted with deep anxiety of the very likely consequences of radiation on their children and future generation. Yet, wars and conflicts are still going on globally and nuclear weapons are being used to threaten others. The damaging power of current nuclear weapons, and moves to develop new “weapons of the evil spirit” that could wipe out the entire human race, destroy the environment and all other creatures on this planet.*

*The importance of the ban of nuclear weapons cannot be relegated to the fringes of policy discussions. There is an urgent need to ensure that nuclear disarmament is moved to the center stage. All nations must prohibit the use, development, production and possession of biological weapons and also ban and eliminate nuclear weapons by treaties. As we all know, nuclear weapons are far more destructive than chemical weapons.*

*The continuing worsening of the nonproliferation regime, the uncertainty of the position of Russia and the US in this regard, the rapid rise of North Korea as a nuclear-weapon state and of Iran as a possible weapon state, concerns about another new nuclear power, Pakistan, and great concerns about disclosures concerning nuclear weapon programs in Libya, Syria, and possibly Burma have all raised.*

*Nuclear weapons are being used to threaten others, wars and conflicts are still going on in the world, and many lives of innocent people are lost. We can and must think more deeply about the significance of moving the money from war to*

*peace and their relationship to social development. We can and must think about what to do to sustain our future, and planet by protecting the environment, increasing social development funding, and other needed public services that could otherwise have gone into military expenditures causing massive loss of lives and resulting in millions of dollars in military expenditure.”*

**Théa Marie Robert,**

Choreographer and Poet, France,

[https://peacefromharmony.org/?cat=en\\_c&key=467](https://peacefromharmony.org/?cat=en_c&key=467)

*“The absolute opponents of nuclear weapons and absolute supporters of their prohibition are women and minor children, who, on average, make up about 70% of the population. Therefore, the gender/child dimension of the prohibition of nuclear weapons is the main one in terms of the scale of its demographic influence and population weight. Likewise, the significance of this dimension in the positive support of the **“Global Security/Peace”** system justified in our **“Peace/Cyberspheronics Manifesto”**. Therefore, gender is a priority for ICAN. We, as leaders of the international Women GHA ([https://peacefromharmony.org/?cat=en\\_c&key=815](https://peacefromharmony.org/?cat=en_c&key=815)) and various national and regional women’s organizations, are ready to provide all-round organizational and informational support to ICAN within our areas of work on the ground. We are also ready to take the most active intellectual participation in the creation, development and implementation of the special international gender/children’s program of the ICAN together with its women leaders. We pay special attention to the need for minor children to participate in the **World Survival Referendum** according to the GHA methodology/bill, which provides for the right to vote of these children, but that is performed by their parents, primarily mothers (Semashko, DeWitt, 2004). The participation in this referendum for children, to which they have no less life right (if not more) than the adult population, will make its results both most socially significant and most humanistically valuable, ensuring its victory, which will be indefinite only with an adult participation in the referendum. Women can also take the leadership in the **“Gandhian, Non-Violent Literacy”** program offered by our **Manifesto** and funded by ICAN. There are many other aspects of the gender/child dimension, for example, artistic, medical, poetic, sports and the like, which play a very important role in banning nuclear weapons and creating a global security/peace system.”*

**Takis Ioannides,**

Dr Literature, Historian, Writer, Poet, Greece,

[https://peacefromharmony.org/?cat=en\\_c&key=138](https://peacefromharmony.org/?cat=en_c&key=138)

*“Nuclear weapons are the pinnacle of total human violence, denying and destroying the entire pyramid of biological and social life that created it and which this monstrous weapon is aiming to destroy under it. Only insane suicides could create it, nurture it for 75 years, become its voluntary slave/hostage and not even think about the saving alternative of the **“Global Peace Science”** (2016), banishing away any thought of its prohibition. Therefore, the ICAN initiative is a great heroic enthusiasm in the spirit of the bright and reasonable heroes of Hellas, who defeat hordes of unreasonable evil monsters that lie in wait for a person at every step. The ghosts of the nuclear weapons development of 75 years have arisen historically create great responsibilities in humanity nowadays. A new perception of the new millennium must be built. According to Greek thought, in order to solve any problem, we must identify the source that produces it, the cause of its creation, and stop it in time. Only*

scientists' specialists make nuclear weapons. We must stop them somehow. Second, we must educate the kids properly in all levels of education. Our Gandhian "**Peace/Cyberspheronics Manifesto**" is a nonviolence sword of the compressed highest achievements of the human mind, cutting of the heads of the world Lernaean Hydra of the nuclear weapons and militarism/violence in general. Only in the unity of the ICAN and the GHA can one hope for the success and victory of the ban on nuclear. We shall act as a team, as we use to do all these years in GHA."

**Michael D. Knox, PhD,**

Psychologist, Founder and Chair, The US Peace Memorial Foundation,  
[https://peacefromharmony.org/?cat=en\\_c&key=928](https://peacefromharmony.org/?cat=en_c&key=928)

"Our US Peace Memorial Foundation supports ICAN in prohibiting nuclear weapons and is in solidarity with the Global Harmony Association's "**Peace/Cyberspheronics Manifesto**" aimed at fundamental scientific justification of the ICAN action by creating a **Global Security/Peace** system that excludes war and weapons. These joint actions of ICAN and GHA will become a good spiritual and scientific basis for our planned "**US Peace Memorial**" in Washington, DC. It will be able to propel the United States towards a culture of peace and to motivate/inspire thoughtful and courageous Americans and US organizations that oppose US wars, primarily against genocidal nuclear weapons."

**Vladimir Onoprienko, PhD,**

Economist, Noospherologist, Russia,  
[https://peacefromharmony.org/?cat=ru\\_c&key=819](https://peacefromharmony.org/?cat=ru_c&key=819)

"The nuclear weapons prohibition is the salvation of humanity from the necrosphere and the harmonious noosphere of Vernadsky, Kaznacheev development.

It is known that V.I. Vernadsky and Pierre Teilhard de Chardin admitted the possibility of self-destruction of the noosphere almost a century ago (Onoprienko, 2014; Ronfeldt, 2020). But only at the end of the last century and the beginning of our century it became clear how this could happen. This question was deeply comprehended by Academician V.P. Kaznacheev (2014). The main meaning of his concept is as follows.

1. Already Vernadsky began to talk about the noosphere entry into the necrosphere period (Vernadsky, 1945), linking it with the rapid depletion of energy trophic life resources under the influence of the population prevailing technosphere elite and dismembered geopolitical poles.

2. The process of depletion of energy is very fast. According to calculations of energy and trophic sources, including water and air, with the current volume of absorption of this external environment, it will be enough on planet Earth for no more than 50–100 planetary years, and then there will be a super deficiency. Kaznacheev defined this growing process as the concept of "**genetic default**" in the evolution of the Biosphere and the human mind.

3. The use of the planet energy and space in the technosphere/necrosphere version of the noosphere does not solve the problem of the civilization survival. The entropy of living space is accumulated by nature itself on planet Earth very slowly, and the technosphere, necrosphere shells, in which humanity destroys planetary reserves, are formed very quickly. The discrepancy between the rates of the natural-space biosphere movement and the development of the necrospherical/technogen-ic imbalance is irreversible and irreversible.

4. *The necrosphere/technogenic space created by modern scientific directions is only the embodiment of the physical/chemical/technical priority, which has become a socio-political dead end of the natural and technical sciences, deprived of the priority of the humanities and environmental sciences, which determine the highest values of life and survival of human and society.*

5. *The final process of the technocratic necrosphere is the rapid priority development and financing of nuclear weapons that have reached the highest levels of perfection in power (according to a Hiroshima for every inhabitant of the planet) and in the supersonic speed of their delivery to any corner of the common home. According to nuclear scientists, humanity is now only 100 seconds away from a global nuclear genocide (Mecklin, 2020), which can only be ended by an early ban on this suicidal weapon. This weapon, together with its generative reasons: global confrontation, the military-industrial complex as the pinnacle of the technosphere, and the democracy funding it, transform the noosphere into a necrosphere. Therefore, together with the ban on nuclear weapons, a turn from the necrosphere to the harmonious development of the noosphere will begin through the mastery of its noospheric thinking by the societal genetic structure of spheres and spherons, disclosed in our **"Anti-Nuclear Manifesto"**. There is no other way for the survival of the noosphere."*

### **Guy Crequie,**

French writer, messenger of peace and observer,  
[https://peacefromharmony.org/?cat=en\\_c&key=106](https://peacefromharmony.org/?cat=en_c&key=106)

*"Nuclear weapons are the greatest evil that can only be overcome by the **'greatest force of nonviolence'** of the Gandhian spherons, which are **'mightier than the mightiest [nuclear weapons] of destruction'**. This greatest humanistic force was forefelt by many before Gandhi, especially Leo Tolstoy and Romain Rolland. The greatest force of non-violence, overcoming the greatest destructive force of nuclear weapons, found scientific, fundamental awareness and justification by world statistics in the global peace science, in **"Cyberspheronics"**, created in the GHA during 15 years and presented most convincingly in the book **"Gandhica"**, 2019. This science allows us to build a global security/peace system that makes any weapon redundant, primarily nuclear. It offers a constructive, non-violent third way out of the impasse of violence and militarism, in which the world today finds itself thanks to their efforts. It deserves the closest attention of the UN as a fundamental scientific justification for the nuclear weapons ban and further general and complete disarmament. Unfortunately, the UN has not yet found similar scientific instrument, 75 years after the first, misanthropic and criminal nuclear test in Hiroshima and Nagasaki. Therefore, its discussion in the UN is extremely topical and vital that will speed up and make more effective the achievement of agreements and the signing of relevant treaties between nuclear countries on the prohibition of these weapons. In my book **"Messenger of Peace"** (2020) I formulated a number of similar proposals of this science for the UN."*

### **María Cristina Azcona,**

Bilingual MCA, GHA VP, WWPO Founding President, Argentina  
[https://peacefromharmony.org/?cat=en\\_c&key=36](https://peacefromharmony.org/?cat=en_c&key=36)

*"The year 2020 presents a unique opportunity for all the peacemaking organizations applied to strive all together to abolish nuclear weapons definitely, closing this tragic period of humanity since its apparition over the Earth. The Corona Virus has made us more prepared on technologies of communication to use them for peace and for the abolition of nuclear weapons.*

*The Global Harmony Association (GHA) is definitely a place for international dialogue among many personalities centered in this proposal and objective, thanks to which their thoughts were integrated into the “**Anti-Nuclear Manifesto**” jointly with ICAN. The Manifesto creates a true, scientific path towards global peace and the prohibition of nuclear war.*

*Therefore, I think that Peace will be real; also, I think peace is near in our century. A trip of a thousand steps starts with only one-step. This is my dream, to see human beings use their brain, intellect and new science in the process of achieving peace. I dedicated my life since thirty years ago to the realization of this dream and will continue without dismay to see result, to teach the youngsters with nonviolent movement in this direction. There is no other way of making the world be a better place primarily without nuclear weapons.”*

**Michael Ellis, MD,**

Global Peace Centre President, Australia,

[https://peacefromharmony.org/?cat=en\\_c&key=760](https://peacefromharmony.org/?cat=en_c&key=760)

***“Times after Hiroshima/Nagasaki End.***

*Time only accelerates*

*To the end times of*

*Nuclear bombs crushing*

*Hiroshima and Nagasaki.*

*War clouds of the Anthropocene era*

*Drag technocracy and military might*

*Into the consummation*

*Of trillions upon trillions of dollars*

*And only a psychotic trans-human*

*Caricature remains of what was human sanity.*

*But it wakes up and rises to new heights*

*In the Gandhian spherons of humanity,*

*Composing its “greatest force of non-violence”*

*Verified by world statistics.*

*Spherons are the eternal source and actor of the human race survival,*

*They provide it with a nonviolent, peaceful and harmonious era,*

*When they will master, will study from childhood*

*And enlighten all life in a new*

*Humanistic science of global peace,*

*In Gandhian Cybersferonics.*

*It was first created by the GHA international efforts,*

*To provide a scientific basis for*

*Permanent prohibition and exclusion from human life*

*First, nuclear weapons, and then all weapons, wars and violence in the 21<sup>st</sup> century.”*

**Alexander Tonkonogov, Ph.D.,**

Professor, Presidential Academy of National Economy and Public

Administration, Head, Institute of Spiritual Security, Russia,

[https://peacefromharmony.org/?cat=ru\\_c&key=847](https://peacefromharmony.org/?cat=ru_c&key=847)

*“Leaders of all world countries should agree for a long time on the creation of scientific teams developing a single system of global security for humanity. These issues should at least begin to be discussed and not to swear at meetings of the UN*

Security Council. Such behavior only leads to further moral degradation of humankind, the continuation of the planet technogenic destruction and to our common physical death, predetermined by these actions and the nuclear weapons created for this. Can humanity in these conditions of its unreliable (from the point of view of elementary security) position allow itself to also conflict in its Noospheral World? Of course not, it just goes against common sense! But at the heart of this logical contradiction is the absence of a single moral paradigm. All the great Russian Cosmists (N.F. Fedorov, K.E. Tsiolkovsky, V.I. Vernadsky, A.L. Chizhevsky, S.P. Korolev and many others) spoke about these obvious problems of the Earthlings in sufficient detail. Isn't it immoral (regardless of country or nation) to spend trillions on weapons production when millions of people are starving, lacking sufficient drinking water, adequate health care, housing, education, etc.?

We are divided, we do not have a global salvation plan. This is what we need to negotiate at the UN, and not swear like savages! The accidents at the Chernobyl (1986) and Japanese (Fukushima-1, 2011) nuclear power plants show our technical and technological vulnerability from the slightest earth vibrations, as well as from managerial mistakes of the people themselves. This is taking place in a situation of global escalation of tension and zugzwang of international relations, in which the leaders of different countries no longer trust each other, but robotic technology, artificial intelligence systems, which in turn can give a catastrophic failure. The author once again emphasizes that this is exactly what the heads of countries and peoples need to think about, using all international institutions to expand the global dialogue. To this they are encouraged by our "**Anti-Nuclear Manifesto**", proposing an innovative cybernetic paradigm of global security/peace based on the Gandhian spherons, verified by world statistics. People do not have their own separate local interests in the world, there are the interests of the Earthlings. If we do not understand this now, it may be too late tomorrow!"

**Ashok Chakravarthy Tholana, Dr.,**

Poet-Writer-Reviewer, India,

[https://peacefromharmony.org/?cat=en\\_c&key=286](https://peacefromharmony.org/?cat=en_c&key=286)

*"While love, harmony and peace purify our souls and mind*

*The unsafe nuclear weapons are contaminating our lands;*

*Is it not a malicious inhumanity and crime against humanity?*

*Is it not a global genocidal terror looming large with ferocity?*

*Unless we dispel the fears of hate, prejudice and hegemony*

*And, replace them with social, racial and ethnic harmony;*

*We can diffuse conflicts and create trust-worthy interactions*

*And open the doors for discussion, dialogue, and negotiation.*

*The instinct of egoistic dominance is sowing seeds of conflict*

*Mutual trust over the years is gradually becoming mistrust;*

*Deserting ideologies, why are nations vying for nuclear race?*

*In same spirit cannot they make the earth a harmonious place?"*

**Vera Popovich,**

Culturologist, archivist, Russia,

[https://peacefromharmony.org/?cat=ru\\_c&key=578](https://peacefromharmony.org/?cat=ru_c&key=578)

*"Nuclear weapons pose a huge threat to the entire planet. Any use of it would be an ecological and human disaster. So that no one in the world can repeat the genocide of Hiroshima and Nagasaki, all states possessing these malfea-*

sant weapons must agree among themselves not to use their and strictly observe the agreements reached. Any “bad peace is better than a good war.” **The Peace/Cyberspheronics Manifesto**, created in the GHA, is an anti-militarist manifesto based on harmony, love and non-violence of the Gandhian spherons. It calls for the development of a new scientific peacemaking consciousness, so necessary today to save humanity and nature. This is the main thing today, 75 years later, when it became clear which more powerful force is capable of putting an end to nuclear weapons – this is the “**greatest force of humanity nonviolence**” of the Gandhian spherons, which are disclosed in the GHA books and projects for 15 years of its work”.

**Andrey Semashko,**

Technician, Russia,

[https://peacefromharmony.org/?cat=ru\\_c&key=748](https://peacefromharmony.org/?cat=ru_c&key=748)

*“The creation of nuclear weapons and their maintenance in combat readiness is useless for the life of humanity as a whole, a waste of energy, time, resources (both planetary and intellectual) and beneficial only to separate states interested in maintaining the pathological policy of global confrontation and tension. In a nuclear war, there will be no winners or losers, this war will be the final point for all of humanity.*

*How much time and effort has already been spent to create 15,000 units of nuclear genocide and how much more will it take to destroy and eliminate it. The sooner the powers that be will face the truth and realize the futility of the nuclear race, the sooner they will be able to channel the huge amount of released funds into solution of global world problems of ecology, pandemic and others. To “reset” their consciousness and thinking, first of all, our “**Anti-Nuclear Manifesto**” was created as a manifesto and primer of “**a substantially new**” (Einstein), scientific, non-violent, peacebuilding Gandhian consciousness/thinking by spheres and spherons.”*

**Bruce L. Cook, Ph.D.,**

VP/Co-founder, Worldwide Peace Organization, USA,

[https://peacefromharmony.org/?cat=en\\_c&key=544](https://peacefromharmony.org/?cat=en_c&key=544)

*“**Nuclear Midnight.** Nuclear disaster threatens humanity with misery and extinction. How can we deal with this before it is too late? Mahatma Gandhi and his universal, equal Spherons, possessing “**the greatest force of the humanity nonviolence**”, will warn us, although we were infants at the time of Hiroshima/Nagasaki and did not understand them. In our age of innovative science of Cyberspheronics, which realized the Gandhian spherons and free communications, nonviolent solutions are the only sensible way to resolve today’s problems. Sadly, despite today’s advanced tools for science, communication and negotiation, we cannot feel secure that no political leader would unleash nuclear weapons.*

*We must realize that nuclear weapons are still being developed, largely because they enable economic rewards to every country involved. Further, and equally alarming, is that every nuclear power is presently developing war plans in case nuclear weapons are unleashed. Despite claims that nuclear weapons are for defensive purposes only, it seems a terrible possibility that at least one country will spread venom against a hated enemy by unleashing a “test” weapon.*

*In case we try to ignore the human disaster that nuclear war will inevitably bring, please read this scientific account by Steven P. Lee (2018) entitled **Minimizing the Danger of Nuclear Weapons**. His chapter vividly describes the horror of worldwide nuclear devastation. No doubt, our continued peaceful existence is under serious threat.”*



**Heli Habyarimana,**

B.A. Linguistics, Peace Activist, Kigali, Rwanda,  
[https://peacefromharmony.org/?cat=en\\_c&key=361](https://peacefromharmony.org/?cat=en_c&key=361)

*“A nuclear-weapons-free world has been **“a rhetorical question and an idea as old as the nuclear bomb itself”** (Blechman, 1985). Humanity in which nuclear weapons are totally eliminated is still a chimera, especially because of a little and even impossible cooperation between nuclear weapons superpowers and states.*

*Nevertheless, this **“disarmament to save humanity”** proclaimed by the Secretary General of UN in 2018, along with multiple efforts and initiatives from ever 1945, should enhance people’s awareness of the threat posed to humanity by nuclear weapons and therefore the unconditional necessity for their total prohibition. Nobody should close eyes before the higher risk for human health and survival, neglected infections and disease gaps, poverty burden and literacy disparities, which should be resolved by deeply shocking costs to maintain these nuclear arsenals.”*

**Stephen Amoah, PhD Applied Statistics,**

Ghana Statistical Service (GSS), Head of Statistical Unit,  
[https://peacefromharmony.org/?cat=en\\_c&key=837](https://peacefromharmony.org/?cat=en_c&key=837)

*“The use of and manufacturing of nuclear armament is no doubt the most critical threat to continual existence of humanity. In our quest to find solution to this worrying situation, it appears the focus has mainly been on campaigns, speeches, and creation of pressure groups. There have also been introduction of innovative scientific models to facilitate the solution of the eminent disaster facing humankind. One of such innovative models, with a huge potential to peacefully address this situation is the Cyberspheronic model, which covers 4 key components of humanity: 4 productive spheres and 4 spherons employed in them, in which the population is included from birth to death.*

*The spherons, first intuitively discovered by Gandhi in ancient Indian society as “varnas”, which existed for more than a thousand years in prehistoric times, were substantiated theoretically and empirically and received statistical verification by world statistics during 15 years of the GHA’s work, especially in its last book **“Gandhica”** (Semashko, 2019). It defines the foundations of Cyberspheronics as a science of global security/peace based on the genetic, societal structural harmony of the spheres/spherons of humanity at all its levels, starting with the individual, family and nation.*

*The spheres/spherons ensure peace, security and well-being of every human society. If it teaches and prepares children for adulthood in this fundamental knowledge, then children grow up and become leaders and scientists who find ways to get rid from genocidal nuclear weapons and provide only peaceful nuclear energy. Similar education and upbringing from childhood will ensure the population development on the principles of love, equality and justice, excluding wars, militarism and violence. The chances of nuclear weapons, like other weapons would be minimal if not totally eliminated. The children will not become part of a global system perpetuating the nuclear agenda. Right since infancy, it is necessary to teach our children the Gandhian principles of love, non-violence and peace of spherons, laid by God in the very depths of social nature in its genetic code of survival, now revealed by Cyberspheronics and embodied in our international **“Anti-Nuclear Manifesto”**. Education of children on its basis will exclude for them the path of militarism and pro-nuclear weaponry. It is never too late to follow this new opportunity of our century.”*

**Muhammad Zafar Iqbal, Ph.D.,**

Professor Emeritus in Physics, Qaid E Azam University, Pakistan,  
[https://peacefromharmony.org/?cat=en\\_c&key=847](https://peacefromharmony.org/?cat=en_c&key=847)

**Noor Muhammad Larik, Ph.D.,**

Former Director General, Federal Bureau of Statistics, Pakistan  
[https://peacefromharmony.org/?cat=en\\_c&key=722](https://peacefromharmony.org/?cat=en_c&key=722)

**“Nuclear Holocaust.** *What can be more convincing against the spread of nuclear weapons than the horrendous destruction wreaked by the two atomic bombs ever used against humanity on the unfortunate cities of Hiroshima and Nagasaki during the Second World War? The immediate massive casualties of these most disastrous incidents aside, the long-term hazards unleashed by these tragic events have continued to this day, reminding us of the grave consequences of such a lethal adventure based on nuclear weapons. If there is a lesson to be learnt from that tragedy, it is to give up not only the use but also the possession of nuclear weapons. The possession of nuclear weapons post-World War II, leading to a mindless race for the acquisition of these lethal instruments of warfare, achieved nothing but diversion of an enormous amount of national resources of numerous nation states from the dire development needs of suffering humanity inhabiting many of these nations.*

*Many of the weaker developing nations were also forced to join such a race motivated by their regional and local political compulsions, bringing even more misery to their toiling masses. There can be no justification for such mindless diversion of valuable national resources to such a race on a path for mutually assured destruction. Nuclear weapons are a plague on the earth differing from earlier plagues in that they are not from God but from men. It has origin in a mix of fear, pride and folly of which folly remaining. It resides in the fact that nuclear weapons through acquired for security infect heighten insecurity. Time has finally come to raise voice against nuclear weapons and unconditionally support the UN Treaty on the Nuclear Weapons Prohibition initiated by ICAN, scientifically substantiated by the statistically verified Gandhian spherons in our international “**Anti-Nuclear Manifesto**”, which deserves priority attention on the UN, governments, science and media agenda.”*

**Uraz Baimuratov, Professor,**

Academician, Kazakh Academy of Sciences, Research Institute Director, Kazakhstan,  
[https://peacefromharmony.org/?cat=ru\\_c&key=561](https://peacefromharmony.org/?cat=ru_c&key=561)

**“Kazakhstan is a nuclear disaster zone.** *The Semipalatinsk nuclear test site, opened in 1947 on the territory of Kazakhstan, became a whole zone of ecological and social disaster in Kazakhstan. According to official data, for the entire period from 1949 to 1989, 456 nuclear explosions were carried out on it, with a total yield of over 50 megatons. More than 1 million Kazakhstani became victims of the tests. In 1989, the anti-nuclear international movement “Nevada-Semey” emerged in Kazakhstan under the leadership of the famous Kazakh poet and public figure Olzhas Suleimenov. The Semipalatinsk test polygon was closed by the Supreme Soviet of the Kazakh SSR on May 22, 1991.*

*However, not all test sites in the world have been closed, some countries of the world have a huge nuclear potential, which poses a great threat to nuclear war. How to prevent the outbreak of a world nuclear war? **All world crises, cataclysms and conflicts are synchronous and mutually reinforce each other.** No form of disharmony is completely surmountable without other forms being simultaneously eliminated. Now many minds are trying to find recipes for crises and military conflicts without identifying their origins. From here only the symptoms are treated, not the genetics of the disease.*

The currently dominant narrow, technocratic approach leads away from the truth. And the road to it lies through a harmonious consciousness that recognizes the primacy of the spiritual over the material, and not vice versa, which is a dead end. The potential of the Earth must be used only for peaceful, constructive purposes, remembering its limit, that humanity has already exhausted its limit of rough interference in the environment. Strengthening spirituality and morality, the dialogue of civilizations, the establishment of trust in international relations, the consolidation of forces in the fight against crises, cataclysms and conflicts – this is a saving path that has no reasonable alternative. It is deployed in many of our works, as well as in the proposed “**Anti-Nuclear Manifesto**” with my participation on the basis of the four-dimensional spherical paradigm  $D + 3D$  (2015). **Its motto is: consolidation, cooperation, partnership, not confrontation** that expresses our common human hope: “**Harmony will save the world!**”

**Hasina Parvin,**

CEO & Editor-in-Chief, World Growth Forums, India,  
[https://peacefromharmony.org/?cat=en\\_c&key=960](https://peacefromharmony.org/?cat=en_c&key=960)

**“Gandhian nonviolence as an alternative of harmony, peace and love to nuclear weapons.** Mahatma Gandhi advocated for elimination of violence worldwide. His concept of non-violence (Sanskrit word Ahimsa) embraced harmony, love and peace. He believed that one’s love towards a person or the entire humankind means one would never harm that person or the entire humankind. Mahatma Gandhi stressed that ‘**non-violence is the greatest force at the disposal of mankind. It is mightier than any weapon of mass destruction.**’ We do not need nuclear weapons to win any war or the world; the world can be won only through brotherhood and respect towards every other person’s existence and rights.

A mission of global nuclear disarmament is crucial for world peace and growth. The 75-years-old Hiroshima and Nagasaki tragedy reminds us that the entire world is everyday living on its own grave with a feeble hope that no country would ever take advantage of its nuclear arsenal to threaten or defeat another country.

The COVID-19 pandemic has reminded all of us where our priorities lie: building a better world, not destroying or creating the means of destructions. The world leaders must get up, pledge and take action now towards a gradual elimination of all nuclear weapons from the world.

As the CEO & Editor-in-Chief of World Growth Forums – an international Platform of Excellence firmly committed to positive growth of world – I support combined efforts of world NGOs and individual persons towards a world free of nuclear arsenal and safe for the entire humanity.»

**Alfredo Sfeir-Younis, PhD,**

The IAEWP Executive Vice President, Chili,  
[https://peacefromharmony.org/?cat=en\\_c&key=959](https://peacefromharmony.org/?cat=en_c&key=959)

**“Nuclear Weapons: Imposed all-out-war; the humanity highest priority is its ban.** It is the first time in human history, when nuclear weapons have physically empowered few people who could stop ‘time and space’ in a few seconds and, thus, could destroy our hopes for a peaceful future. This is the reason I decided to be part of this “**Manifesto**”. We must dismantle all nuclear weapons one by one. Nuclear weapons, and our global society managed by them, are not the collective governance we must accept to guide our collective life on this planet. The morality of

an imposed all-out-war is a misguided ego-based-power. This is 'outer power', driven by greed and disrespect for human rights, nature's rights, and a harmonious interdependence, which embrace both peace and prosperity. Humanity cannot co-exist with nuclear weapons, ecological destruction, or a progressive dismembering of community structures. As our planetary consciousness raises, we must embrace the moral imperatives and responsibilities towards all future generations. We must adopt **a morality of care**: compassion, respect, cooperation, justice and solidarity within all forms of life on the planet. The absence of **conscious leadership** has given way to ruling the planet with weapons of mass destruction rather than with the vision emanating from our highest states of consciousness.

We are at a turning point and the **cold war** must not come to an end with a **hot war**. Today, nuclear weapons mean suffering, insecurity, disempowerment, fear and despair, and they are not a source of global security. **The only source of security is everlasting peace, love, friendship, and solidarity**. Many countries have a wrong notion of victory, success, and hegemony. Hegemony by weapons must be totally replaced by hegemony of consciousness. We need new outer and inner solutions accompanied with intelligent investments. Let us not delay, let us not wait any longer. **The nuclearizing of the planet has to stop. This is our highest priority**. While a nuclear warhead gives power to today's political establishment, the inner peace, of all planetary citizens, is the most solid foundation of world peace, and they are the source of our physical and spiritual nourishment. I oppose to all forms of weapons. The only and greatest foundation of humanity is its own collective consciousness. We all have choices. Let us not give our world to those who are afraid of being and becoming love and peace."

**Terence Barry,**

Executive Director, Generation Hip-Hop Global (GHHG), South Africa,  
[https://peacefromharmony.org/?cat=en\\_c&key=961](https://peacefromharmony.org/?cat=en_c&key=961)

**"GHH Anti-nuclear.** As Generation Hip Hop we strive to progressively educate youth about what we have in common, not our political, socio economic or religious based differences. It is vital that we see the potential of the global village and humanity and inspire youth to not just imagine a peaceful society but to actively create it. Nuclear weapons have no place in a world dedicated to peace and are all but redundant in the predominant narrative of the global village. Ensuring that we educate the next voting generation accordingly is the priority of the GHH mandate."

**Adam Greenwell,**

Producer of multi-media, writer, and social entrepreneur, New Zealand,  
[https://peacefromharmony.org/?cat=en\\_c&key=912](https://peacefromharmony.org/?cat=en_c&key=912)

**"The best anti-nuclear idea for New Zealand, which never had and did not want to have nuclear weapons and which ratified in 2018 the UN Treaty on the Prohibition of Nuclear Weapons, initiated by ICAN, is the IPPNW idea: "Medical recipe for the humanity survival" (Chazov, 1985). It reads: "To save humanity, we must arouse the conscience of the world's peoples, cultivate hatred for nuclear weapons, repudiate egoism and chauvinism, and create favorable atmosphere of trust. In the nuclear age, we are all interdependent. The Earth is our only common home, which we cannot abandon. The new suicidal situation calls for the new thinking. We must convince those who take political decisions.»**

*In order to awaken the consciences of the world's peoples and create a favorable climate of trust, it is necessary to create a broad overview cultural perspective that is understandable to all citizens. It embodies hope and unity, expresses and reinterprets the ancient communications of music, literature, visual arts, cinema and dance. They confirm the great **"medical recipe for the humanity survival."** The love of truth is empowered by the truth of love. Through the example of Gandhi, we can see the general human interdependence in non-violence, peace, harmony and love. Therefore, we are creating this non-violent culture of peace, balanced with the people's goodwill and the spirit of justice. It excludes any destruction and violence, above all the absolute of them - nuclear weapons. It finds its real embodiment in the Global Security/Peace system of Gandhian spherons, deployed in our "Anti-Nuclear Manifesto", which ensures the humanity survival and prosperity."*

**Urbain Kapoko,**

Democratic Republic of the Congo, Kinshasa,

***"There is no nuclear weapon in the world.** The silence on this score has swallowed up the world peoples and the lies of powerful powers that surround them with nuclear weapons are phantoms that lull humanity to sleep. The nuclear weapons are designed to destroy innocent humanity threatening our society. These weapons are not capable to prevent or resolve a single conflict. They pose a mortal danger to the planet. The South countries blame the industrialized nations for being the planet's main nuclear weapons developers and emitting seven times more CO2 than the rest of the world combined. The United States and other nuclear powers are responsible for the nuclear weapons miniaturization drift and the preparation of its tactical use. The non-proliferation of nuclear weapons and their elimination is a decisive factor in saving humanity. Mobilizing and raising awareness of the true threats of these weapons through the civil society organizations is a prerequisite for abandoning them, destroying them and creating a secure world. The **«Anti-Nuclear Manifesto»** with its **«World Survival Referendum»** and building a scientific system of **Global Security/Peace** acceptable to all peoples provides this world. Its construction continues, deepens and expands the **"UN Nuclear Weapons Ban Treaty"**, which was initiated by ICAN in 2017."*

**Delasniewe Daspét**

Poet, Lawyer, Peacemaker, Teacher, Campo Grande, Brazil

[https://peacefromharmony.org/?cat=en\\_c&key=664](https://peacefromharmony.org/?cat=en_c&key=664)

***"Red tulips.** Radioactive. Genocidal.  
They killed Hiroshima and Nagasaki.  
We live in fear of nuclear weapons.  
It's like the sword of death created in our heads.  
At any time, without notice,  
They can disintegrate us.  
They are an affront of the life continuity.  
The nuclear conflict would be a war without winners.  
The land would end by a radioactive graveyard.  
May the red tulips remain in our memory.  
We must seek the Gandhian peace from the spherons harmony  
How the GHA does it to exclude the war.  
Why don't we know a society without war?  
Because we do not know Gandhi's law of nonviolence."*

**Anam Kumar,**

Managing Director, World Growth Forums, India

[https://peacefromharmony.org/?cat=en\\_c&key=965](https://peacefromharmony.org/?cat=en_c&key=965)

***“Mahatma Gandhi: non-violence, peace, love instead of nuclear weapons.***

*It is high time the world opens its eyes and understands how destructive nuclear weapons could be for the entire planet. All evolution, growth & development, and advancements & achievements of the humankind may be wiped out from the face of Earth forever, with a single mistake in handling of nuclear weapons.*

*It is also high time the world looks back at what Mahatma Gandhi – one of the greatest human beings and leaders – offered to the world as a simple solution to all its man-made problems: **embrace non-violence and spread love, harmony and peace.** All humanity must empower themselves with this simple philosophy of Mahatma Gandhi through the new Gandhian science of Cyberspheronics, presented in our **“Manifesto”**, and move to the future with assurance and confidence that a peaceful and harmonious existence is very much possible for the entire world, and is extremely necessary for its future life..*

*It is quite evident that a harmonious evolution of humanity cannot co-exist with nuclear weapons. Either one will have to go! The obvious choice for humankind must be elimination of nuclear weapons, not elimination of humankind in preference to nuclear weapons. However, the final decision depends on the common sense of the humankind leaders, from their mastery of **“a substantially new manner of thinking”** (Einstein) by the Gandhian varnas/spherons, the example of which is given by our **“Manifesto”**.*

*Only through it, the world leaders will be able to make sure that sitting on a pile of weapons of mass destruction is extremely dangerous. Then they will understand the fundamental nature of the positive Gandhian alternative of global peace, non-violence and harmony. Only in this case, humanity will acquire a solid chance for the survival and prosperity of all nations in a new harmonious and non-violent civilization.”*

**Leo Semashko, PhD,**

Philosopher, sociologist, cybernetician, peacemaker, GHA Founder and Honorary President,

[https://peacefromharmony.org/?cat=en\\_c&key=253](https://peacefromharmony.org/?cat=en_c&key=253)

*“The extremely acute world situation with the nuclear threat, global security, ecological catastrophe and pandemic requires from scientists, especially cyberneticians, to be more radical, responsible, solidary and courageous in the development and application of our fundamental science with its unique, holistic, inexhaustible potential, which is disclosed only in general the perspective in our **“Peace/Cyberspheronics Manifesto”**. The Manifesto key excellence, which is necessary, first of all, for the ICAN for the successful and most effective prohibition of genocidal nuclear weapons, is **“a substantially new manner of thinking”** (Einstein) by the spheres/spherons. The mastery of which provides the double impossible: 75 years of inaccessible nuclear zero in the global security/peace system and the holistic circular potential of Wiener’s cybernetics, which remained unknown for humankind and still unused for the noosphere as a whole. It becomes known, organizing, used and working in the Manifesto paradigm only at the level of **“a substantially new manner of thinking”** and in synergy with other potentials of integrity: the Gandhi’s spheres/spherons, Einstein’s thinking, Maturana’s autopoiesis, Vernadsky’s noosphere and the Kelso/Kurland economy in a new form of cybernetics, in Cyberspheronics (CYBS)*

based on the genetic societal spherons of humanity, revealed in **Gandhica** and other GHA books for 15 years.”

The “**Anti-Nuclear Manifesto**” of the world civil society, created in the GHA on the Gandhian nonviolent spherons substance is a special, societal/genetic vaccine of humanity against any violence, first of all against the most terrible, genocidal/ecocidal - nuclear weapons, which, like the sword of Damocles, 75 years hanging on a thin thread over humanity. It puts under question its survival, makes its a hostage, threatening the suicidal extinction of the human race and the entire biosphere on Earth. Of course, like any scientifically created vaccine, our Gandhian vaccine of the antinuclear, nonviolent immunity of spherons, of their thinking and the security/peace system must go through the stage of mass testing in many countries. But it will inevitably be created in the coming years so that it could be used by all nations and entire humanity.”

**Bernard Scott, PhD,**

Cybernetician, psychologist, Britain,  
International Center for Sociocybernetics Studies,  
[https://peacefromharmony.org/?cat=en\\_c&key=255](https://peacefromharmony.org/?cat=en_c&key=255)

*“Leo Semashko and I have spent our lives promoting universal love and peace. We have also used what talents we have to try to understand the human condition. Leo, a sociologist, has studied society. I, a psychologist, have studied how humans interact and learn. We both have used cybernetics to help us construct our understandings. We both believe that love and understanding lead to wisdom. I support Leo in his work to bring about a harmonious society. I thank him for his friendship, his love, and his wisdom.”*

*The Manifesto from Leo Semashko has “Humanistic Essence: Anti-nuclear, Anti-militaristic and Non-violent.” Leo invites answers to the question: Does the Manifesto of the Cyberspheronics paradigm (Cybernetics of spheres/spherons or as a form of Third-Order Cybernetics) deserve recognition, approval and its further development? Yes or no?... Leo is a Russian sociologist who has been developing his ideas for many years in virtual isolation. He is shunned by his fellow sociologists in Russia, who are mainly Marxist in orientation... Leo is very much the creator and owner of his theory...*

*But I have little interest in third order cybernetics. Many theorists invoke a third (or higher) order cybernetics and do say in a variety of ways. Of this possibility, although it may be done, von Foerster states, “It would not create anything new, because by ascending into ‘second-order’, as Aristotle would say, one has stepped into the circle that closes upon itself. One has stepped into the domain of concepts that apply to themselves” (von Foerster, 2003, p. 301).”*

III. Definitions of the Anti-Nuclear Manifesto XXI.

Prohibition of nuclear weapons and its fundamental condition.

1. **The ultimate goal:** achieving global peace/disarmament in 50 years.

2. **The immediate, most important goal:** the approval and implementation of the UN Treaty on the Prohibition of Nuclear Weapons (2017), initiated by ICAN, and subsequent nuclear disarmament in 10 years in the context of global disarmament, outside of which it is unattainable. This is the

most pressing global problem and the most acute pathology of human life in its entire history, threatening its survival. The threat and danger of nuclear annihilation on a planetary scale, which is growing with each year of the accelerated improvement of nuclear weapons, is unparalleled, even in comparison with the Covid-19 pandemic, which is temporary and limited to a narrow scale.

**3. Cyberspheronics (CYBS):** a key intellectual/non-violent instrument of the Manifesto's goals, a non-alternative holistic science of global security/peace. Cybernetics is the best theoretical platform for the peace science, because it is the universal, holistic, free from any ideology and provides a synergy of the most diverse potentials of integrity/wholeness (see section 14.1.). Achieving and ensuring any peace goal, above all the prohibition of nuclear weapons, can and should begin only with the development of this science of global security/peace. Its development requires the international consolidation of the best scientific forces under the auspices of the most authoritative world organizations.

**4. The third, non-violent way of the noosphere, the kingdom of reason on Earth:** it is the only alternative to militarism/violence way of survival and prosperity of humanity in the XXI century, completely freeing it from the planetary threat of nuclear/militaristic self-destruction.

**5. The "Anti-Nuclear Manifesto of Peace/Cyberspheronics"** short titles: Manifesto, Anti-Nuclear Manifesto, CYBS Manifesto; Spherons/Humanity Manifesto; Equality Manifesto; Harmony Manifesto; Dream Manifesto; Bifurcation Manifesto; Democracy Manifesto; Manifesto of: Disarmament; Nonviolence; Survival; Salvation; Life; Justice; Unity; Solidarity; Love; Women; Youth; Gandhi; Spiritual Revolution; Humanism; Ecology; Consciousness; Enlightenment; Education; Breakthrough; Development; Partnerships; Prosperity; Civilizations, etc.

**6. The Manifesto set of titles expresses** the set/scale of its meanings, its pluralism, which as a whole constitutes "***the greatest force of non-violence of mankind/[spherons], which is mightier than the mightiest weapon of destruction***" (Gandhi). For the sake of practical accentuation, its name may be reduced to any of the listed attributes.

**7. The Manifesto humanistic essence** is anti-nuclear, anti-militaristic and non-violent based on the synergy of intellectual holistic potentials of Gandhi, Wiener, Einstein, Maturana, Vernadsky and Kelso/Kurland.

**8. Anti-Nuclear Manifesto** is the ***Gandhica*** abris/synopsis of 82 co-authors from 25 countries (2019: [https://peacefromharmony.org/?cat=en\\_c&key=848](https://peacefromharmony.org/?cat=en_c&key=848), 240 p.). The ***Gandhica*** higher meaning: to ensure the victory of global peace in the 21<sup>st</sup> century, making it inevitable. It contains the cyber-science of global security/peace based on the Gandhian spherons of non-violence, justified by world statistics. ***Gandhica*** grew out of the ***Global Peace Science*** of 174 GHA co-authors from 34 countries (2016, 620 pages) and compressed to 20 pages in the ***Anti-Nuclear Manifesto***. This is the result of 15 years of solidarity international peacemaking and scientific work of hundreds of GHA members on this science.



9. **The fundamental condition** for the prohibition and eradication of nuclear weapons is the global security/peace system.

10. **The CYBS Manifesto is the Spherons Manifesto** and vice versa. This is the spherons first scientific worldview, a fundamental long-term strategy of their future for the 21<sup>st</sup> century, which will be continuously improved in feedback with the practice of its implementation. This is the thinking, consciousness and mind of spherons, their goals, historic mission and the Third, nonviolent, conscious Way to them.

11. **The Anti-Nuclear Manifesto** is open to new coauthors with new anti-nuclear ideas and for support of individuals and organizations. It ensures its continuous improvement and promotion.

#### IV. Global Security/Peace (GSP). Existential Laws

1. **The Gandhian, societal and genetic spheres/spherons of humanity/noosphere are fundamental, defining Gandhi's law for the GSP system.**

Briefly: ***Gandhi's Law: "Four universal societal spheres/spherons constitute the genetic substance of humanity/noosphere, its GSP and prosperity system."***

2. **The GSP: the law of whole/part or integrity/partialness.** Not branches/partons (their groups) provide survival, security/peace of humankind, but only its equally necessary and sufficient, holistic spheres/spherons in their inevitable harmony, love, synergy, equality and non-violence. When the part dominates the whole, it leads to this whole death.

3. **The security/peace of a part is provided only by the security/peace of the whole**, but never vice versa, never by any part of it, no matter how strong and powerful it is.

4. **Einstein's Law-1.** The GSP system cannot be comprehended and designed at the same level of traditional partial thinking, on which the global militaristic system was created and developed, depriving security/peace of every country/part of humanity and therefore forcing each of them to arm and enter the arms race, including nuclear weapons.

Briefly: ***Einstein's Law-1: "The inappropriateness/unacceptability of traditional thinking for solving global problems created by it."***

5. **Einstein's Law-2.** The GSP system can be realized and constructed only at the level of "***a substantially new manner of thinking***" by the Gandhian spheres/spherons of humanity at all its levels. This thinking is substantiated and developed in Cyberspheronics, in the GHA books and projects for 15 years.

Briefly: ***Einstein's Law-2: "The need for a substantially new manner of thinking by spheres/spherons in order to solve global problems and build a GSP and prosperity system."***

6. **Wiener's Law.** The causal circular, direct/feedback connections of societal and genetic Gandhian spheres/spherons are the objective foundation of social Cybernetics, called Cyberspheronics, which excludes ideological distortions, widely uses mathematics and creates new digital technologies.

Briefly: **Wiener's Law:** *"The causal circular connections of societal spheres/spherons are the objective foundation of Cyberspheronics as a holistic Megascience of the humanity GSP and prosperity system in the XXI century."*

7. **Poincare's Law.** *"The internal harmony [of spheres/spherons in the noosphere] is the only true objective reality"* (Poincare, 1913) of humanity, determined by the mathematical laws of their circular connections and constituting an integral object/subject of Cyberspheronics.

8. **Law of the GSP beginning.** The creation of the GSP system beginning and any of its elements, in accordance with Einstein-2 law, can only be the international development of Cyberspheronics as a GSP science, overcoming its main cognitive obstacle – traditional partial thinking: Einstein-1 law.

9. **The Nuclear Weapons Prohibition Law** is a synergy of the laws of rejection of traditional, partial thinking (Einstein's law-1), the recognition of the Gandhian spheres/spherons as societal reality and the transition on their basis to their *"substantially new manner of thinking"* (Einstein's law-2) and building GSP. Therefore, the prohibition of nuclear weapons is not the end of the GSP system, but only the beginning of its construction based on Cyberspheronics as a science of GSP of the humanity Gandhian spheres/spherons.

10. **The Law of conservation of nuclear weapons.** The traditional militaristic security system for 75 years has been based solely on deterrence by nuclear weapons. Therefore, the fundamental grounds for its voluntary refusal will be no until an alternative paradigm will create as the GSP scientific system based on Cyberspheronics convincing for all. This law is the main argument for Cyberspheronics/GSP priority international development in cooperation and trust, excluding confrontation.

11. **The Law of impotence/collapse of traditional pacifist organizations.** It is defined by their contradiction, ignorance, ignorance or inability to understand, take into account and apply the laws of Gandhi and Einstein in peacemaking thinking and action, which, for this reason, have always proved to be failures and powerless in the face of the constantly growing threat of militaristic self-destruction of humanity. This is especially convincingly proved by 75 years of priority nuclear weapons.

12. **Eisenhower's Law.** The Military-Industrial Complex (MIC) is the only subsystem/part of humanity/noosphere specially created for the production, storage, development and use of all types of weapons, including nuclear. Only the MIC requires and benefits from continuous wars, violence, militarism, priority budgetary and continuously increasing funding, priority development of military science, primarily for improving the most effective nuclear weapons. Therefore, only for the MIC the suppression of any alternative of global peace science, any organizational alternative of the Department of Peace, any alternative of peacebuilding and any alternative to their budgetary financing is required and beneficial. These alternatives in various forms tried to break through in different countries for more than two centuries, but

they were all suppressed and strangled in the bud by all kinds of repression, primarily financial, depriving these alternatives of financial resources.

Only the MIC requires and benefits from constant global confrontation, tension, hostility, suspicion, mistrust, alienation, fragmentation, lies, deception, falsifications, threats, sanctions, destruction of cooperation and solidarity in all spheres and relations. The MIC creates a so-called “**militaristic security system**”, built on balancing “**on the war brink**” and intimidation by force: “**PEACE THROUGH FORCE.**” The militaristic security system excludes any possibility of the GSP system, including the prohibition of nuclear weapons. The MIC has become that genocidal terrorist with nuclear weapons who commits “**the outrage of holding the entire world hostage [and] ... continuously targeted for extinction each of us... [so it is for] all nations shared enemy ... [and has already plunged us] in the rubble of World War III.**” (Lown, 1985).

Eisenhower’s Law is particularly impressively proven by the 75 years of nuclear weapons heyday since 1945, since the Hiroshima/Nagasaki Holocaust. The MIC has become the only source of “**nuclear death of humanity**”, the main threat to its survival and a danger to the life of the biosphere, noosphere and the planet as a whole that President Eisenhower first realized and expressed. This law is the most convincing historical illustration of the part/whole law in the case when the part seizes dominion over the whole and leads it to death, while its dominance persists and is not overcome by restoring the priority of the whole over the parts in their harmony.

Briefly: **Eisenhower’s Law: “The military-industrial complex is the main source of the total threat to the survival of humanity and the main purposeful obstacle to the system of Global Security/Peace and Prosperity of all humankind, the solution of all its problems, including the prohibition of nuclear weapons.”**

Eisenhower’s Law can only be overcome by the synergy of the first ten existential laws of the GSP system, four of which form its center.

#### **Summary of the Cyberspheronics Existential Laws in its Conscious Thinking:**

Four key cognitive laws among existential ones for solving global problems to build a sustainable, invincible GSP and prosperity system are:

1. **Einstein’s Law-1: “The inappropriateness/unacceptability of traditional thinking for solving global problems created by it.”**

2. **Gandhi’s Law: “Four universal societal spheres/spherons constitute the genetic substance of humanity/noosphere, its GSP and prosperity system.”**

3. **Einstein’s Law-2: “The need for a substantially new manner of thinking by spheres/spherons in order to solve global problems and build a GSP and prosperity system.”**

4. **Wiener’s Law: “The causal circular connections of societal spheres/spherons are the objective foundation of Cyberspheronics as a holistic Megascience of the humanity GSP and prosperity system in the XXI century.”**

It is a fundamental system of necessary and sufficient laws of thinking of the GSP and prosperity, free from violence, war and militarism, including nuclear weapons. These are conscious, i.e. the self-reflective and self-organizing laws of the scientific mind/thinking of Cyberspheronics. Only the synergy of its existential and cognitive laws can overcome, in theory and in practice, Eisenhower's law: ***"The military-industrial complex is the main source of the total threat to the survival of humanity and the main purposeful obstacle to the system of Global Security/Peace and Prosperity of all humankind, the solution of all its problems, including the prohibition of nuclear weapons."***

The four laws of conscious, ***"substantially new manner of thinking"*** provide in synergy the overcoming/neutralization of **Eisenhower's** law, the solution of all global problems and the breakthrough of humanity into the new Era of Nonviolence predicted by Gandhi. Therefore, about Gandhi not without reason say: ***"Some men changed their times... One man changed the World for all times!"***

Naturally, the Cyberspheronics laws system, which is now presented as a hypothesis, requires constant development of its theoretical and empirical substantiation in its internationally established and funded institutions.

## V. Cyberspheronics.

### The Societal GSP Science: Theory/Thinking

Nonviolence in harmony/peace of varnas/spherons *"is the greatest [but still unknown] force [energy] at the disposal of mankind. It is mightier than the mightiest weapon of destruction. Nonviolence [of spherons] is the law of human life."*

**Mahatma Gandhi**

*"The significant problems we face cannot be solved at the same [partial] level of thinking we were at when we created them." Therefore, "we should require a substantially new [holistic, non-violent, asymmetric] manner of thinking [by spherons] if mankind is to survive."*

**Albert Einstein**

*"Cybernetics ... will only attain its true stature if it recognises itself as the science that reaches out [to know] for that which is hidden [the depth of spherons]."*

**Gotthard Gunther**

**1. Features of Cybernetics and Cyberspheronics (CYBS).** Each science outlines its object/subject, creates its own conceptual/terminological language of its knowledge/thinking, develops its own manner/method of explanation/understanding and offers its own forms of their description/expression and presentation to the outside world. Mathematics, astronomy, physics, chemistry, biology, sociology, history, psychology and other sciences develop their own special way of cognition in all of the above parameters/dimensions.

Cybernetics and Cyberspheronics are not exceptions from this rule, but its continuation. To understand and master these sciences, it is necessary to master their peculiarity in their parameters. Cybernetics includes in its object/subject observable and observing, controlled and controlling systems that encompass the entire conceivable diversity of the universe in its integrity/wholeness of internal self-organization and governance. The universality/integrity of the object/subject of Cybernetics determines its special status as the most interdisciplinary and transdisciplinary science (Scott, 1996, 2004 and etc.).

Cyberspheronics (CYBS), while maintaining the status of Cybernetics, limits its subject only to social governance and only social systems, which are extremely complex in themselves and for cognition. This determines its highest dignity and, at the same time, its particular difficulty, making Cyberspheronics a unique science and the pinnacle of Cybernetics in these respects. To understand and master CYBS below, a thesis description of all its parameters is proposed, a detailed scan and justification of which are presented in *Gandhica* (2019).

## 2. Definitions/Language of Cyberspheronics (CYBS) Spherical Linguistics.

**2.1. Definition-1. The CYBS Science.** *Cyberspheronics is the third-order Sociocybernetics of spheres and spherons, or Cybernetics of societal spheres/spherons within the framework of a pluralistic tetradic philosophy of constructivism (Gandhica, 2019). Cyberspheronics is the science of governance/control (cyber) of spherons and the governance/control (cyber) by spherons in the unity of spherons as an objective/subjective thermodynamic environment, simultaneously observed/observing and governed/governing within their circular causality, consciously organizing its object/subject and consciously self-organizing as its actor according to the measure/level of their knowledge.*

**2.2. Definition-2. Cyberspheronics Object/Subject.** *It is the life/existence of society/humanity as the **noosphere** created by it on Earth. The noosphere is constituted by continuous production/autopoiesis of four necessary/sufficient **resources/products**: People, Information, Organizations, Things (the totality of created material goods and services): PIOT. The PIOT are produced in four corresponding spheres of social production/autopoiesis: Sociosphere, Infosphere, Orgosphere, Technosphere (the sphere of production of material goods and services) by the respective actors/clusters of people employed in these spheres and therefore called "spherons": Sociospheron, Infospheron, Orgospheron, Technospheron. Spheres/spherons differ on the PIOT products. (Gandhica, 2019).*

The spheres/spherons are inextricable duplexes of clusters of social autopoiesis/noosphere: there are no spheres of autopoiesis without its spherons as their sole actors, and vice versa; there are no spherons of autopoiesis without their spheres as their necessary infrastructures. Their indissolubility is illustrated by a similar connection of endless partial examples: schools and schoolchildren, mines and miners, towns and town-folk, physics and physicists, music and musicians, poetry and poets and so on, which do not exist without each other.

**2.3. Definition-3. Spherons of Cyberspheronics (CYBS).** *Spherons are universal. They include all people from birth to death, without exception. The universality of spherons covers all human/social life/autopoiesis in its entirety, without exception, of all people, in all families, schools, enterprises, cities, regions, countries, continents and within humanity as a whole. The spherons of humanity differ only in spheral employment in the spheres of social production/autopoiesis, which is replaced by people in their life process of transition from employment in one sphere to employment in other areas. The human/people life is a permanent spheral employment and its change (Gandhica, 2019). The humanity spherons are presented in this structural model:*

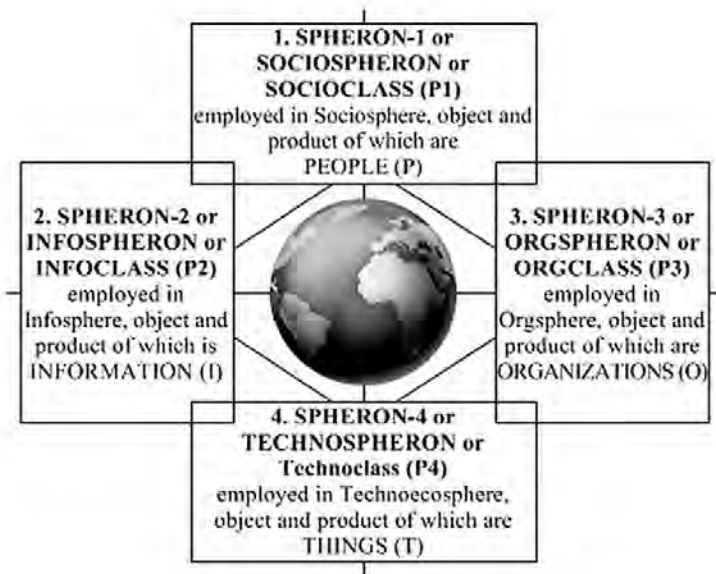

Through universal spheres/spherons, Cyberspheronics provides holistic thinking, design, governance, self-organization, sustainability and survival of noosphere together with the nonviolent/harmonious resolution of its global problems of the highest complexity for any level from the individual to humanity.

**2.4. Definition-4. The CYBS Law of Universal Wholeness (LUW). (Or: The CYBS Law of Necessary Spheral Diversity.)** This is the defining societal/genetic law of humanity, developing the Ashby’s *Law of Requisite Variety* or necessary diversity. This law expresses a constant trend of matching the diversity of the governing system to the diversity of the governed system, which is fulfilled from two sides: from the object side and the governance subject. **The CYBS LUW determines the necessary ontological diversity of an object (society/humanity) to match with which the governing subject (governance as a whole) diversity should strive as follows.**

*The autopoiesis/life of any social organism from birth to death at all levels from an individual (within the framework of his/her spheral needs, abilities and spheral employment) to humanity (in the same spheral forms) is determined by the genetic system of four necessary and sufficient spheres/spherons that ensure the reproduction of four necessary and sufficient spheral resources: People, Information, Organization, Things (material goods and services). In abbreviated form: PIOT. The processes of production, distribution, exchange and consumption of PIOT constitute together with them the corresponding spheres/spherons: Sociosphere/Sociospheron producing P; Infosphere/Infospheron producing I; Orgosphere/Orgospheron producing O; Technosphere/Technospheron producing T. In thinking of social wholeness/complexity at any level, CYBS, as a universal governing system, is limited by the diversity of these 16 spheral clusters/elements in their cognitive/attributional duplexes.*

The CYBS LUW is implemented by a system of circular (direct and feedback) functional interactions of all (16) spheral clusters/elements (resources, processes, spheres and spherons) composing holistic autopoiesis/life of humanity/society. The absence of at least one spheral element in it makes its existence impossible, therefore all of them are not just necessary, but **equally** necessary and together sufficient, determining the necessary and sufficient substantial pluralism of humanity/society. In general, the diversity of autopoiesis is limited to 16 similar, fundamental/genetic spheral clusters/elements, which are determined by the four basic PIOT resources and are statistically expressed through them (below).

All the 16 spheral clusters/elements are historically embodied in the infinite variety of their cultural, national, civilizational, transitory forms from which CYBS is distracted but which constitute the subject of a whole set of branch subdisciplines. CYBS performs a fundamental ontological, cognitive and organisational trans- and interdisciplinary function in relation to them.

The CYBS LUW integrates and develops also all other laws of the first and second order Cybernetics (observable and observing systems) providing through 16 spheral societal clusters/elements the “necessary and sufficient internal diversity” of the all systems viability/autopoiesis within society/humanity.

The CYBS LUW creates the integration/synergy of fragmented disciplines of traditional Cybernetics, overcoming their fragmentation and mutual disorganization. At the highest level of synergy of Cybernetics in CYBS, it produces knowledge of genetic/societal wholeness without which no scientific/system global governance and a democratic solution to any world problem of society/humanity is possible.

**2.5. Definition-5. CYBS Holistic Subject/Object in Statics. CYBS Ontology. Structural Model.** *The CYBS subject/object is the planetary noosphere of the social production/autopoiesis within the biosphere (Vernadsky, 1931) and other spheres of the Earth, composed of four societal spheres/spherons. In accordance with the law of universal whole-*

ness, the noosphere/humanity can be represented by the following structural model along with the noosphere fundamental values, ensuring its survival/stability:

CYBS Object/Subject: Noosphere of Spheres/Spherons and its Survival Values

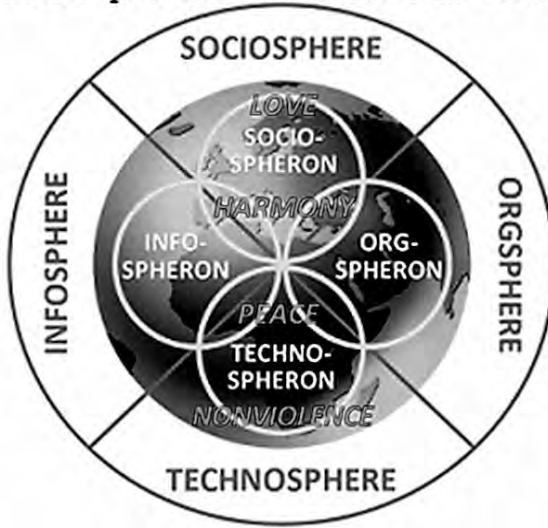

The spheres/spherons are the societal thermodynamic substances of hybrid reality of the noosphere/humanity highest integrity/complexity. The movement to the discovery, cognition and use of spheres/spherons crowns and integrates the development of Cybernetics of the first two orders. In the spheres/spherons of third-order cybernetics, it enters a new level of wholeness/complexity. In spheres/spherons optimizing holistic “assembly of subjects/objects of development” of society/humanity, third-order cybernetics finds self-identification and a synergistic synthesis of “self-developing polysubjective reflective-active environments”, ensuring “harmony of hierarchical and network models ... in three-dimensional space”. (Lepskiy, 2018; WOSC, 2020).

The spheres/spherons determine the genetic structure of any social “reflective-active environments”, transform them into specific “spherical environments”, overcoming their amorphousness. The spheres/spherons remove the problem of the subjectless/structureless development of the noosphere/humanity in their entire history. Spherons are the societal, genetic, higher subjectivity of humanity at all levels, at all times and in all cultures and civilizations.

**2.6. Definition-6. Structural Model: Cyberspheronics Holistic Dynamics.** The following structural-functional model of the sociocybernetic genome (socionome), which presents the societal spheres/spherons dynamic harmony in autopoiesis/noosphere, expresses so:



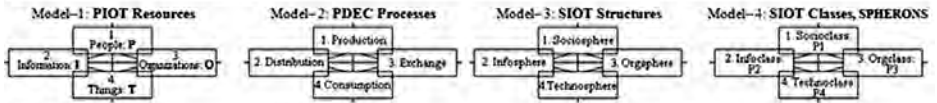
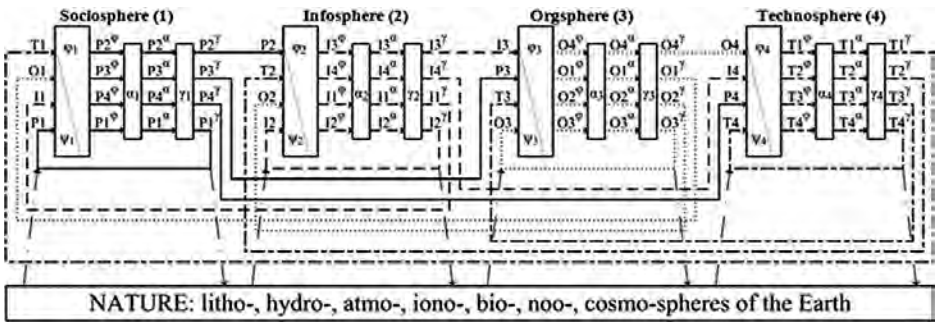

Basic Matrix of Spherical Indices of Resources:  
 $P = P_1 - P_2 - P_3 - P_4$   
 $I = I_1 - I_2 - I_3 - I_4$   
 $O = O_1 - O_2 - O_3 - O_4$   
 $T = T_1 - T_2 - T_3 - T_4$

Indexation:  
**Production:**  $\phi$  (phi)  
 $\phi_1$  - production of people (human resources)  
 $\phi_2$  - prod. of information (information resources)  
 $\phi_3$  - prod. of organizations (organizational resources)  
 $\phi_4$  - production of things (material resources)

**Distribution:**  $\alpha$  (alpha)  
 $\alpha_1$  - distribution of people  
 $\alpha_2$  - distr. of information  
 $\alpha_3$  - distr. of organizations  
 $\alpha_4$  - distribution of things

**Exchange:**  $\gamma$  (gamma)  
 $\gamma_1$  - people exchange  
 $\gamma_2$  - information exchange  
 $\gamma_3$  - organization exchange  
 $\gamma_4$  - things exchange

**Consumption:**  $\nu$  (nu)  
 $\nu_1$  - consumption of sphere-1  
 $\nu_2$  - consumption of sphere-2  
 $\nu_3$  - consumption of sphere-3  
 $\nu_4$  - consumption of sphere-4

More details on SOCIONOME see: *The ABC of Harmony for World Peace*, 2012, 38–43:  
[https://peacefromharmony.org/?cat=en\\_c&key=486](https://peacefromharmony.org/?cat=en_c&key=486)  
<http://youtu.be/hbxY5IREOeA>

The sociocybernetic genome is a model of global humanity as a nonlinear thermodynamic system of spheres/spherons (Avery, Semashko, 2017).

**2.7. Definition-7. Cyberspheronics (CYBS) Holistic Environmentalism.** The noosphere/humanity environment has two levels: Earth (earthly) and Cosmos (outer space). The earth’s environment is represented by its four spheres, known since ancient times: lithosphere, hydrosphere, atmosphere and biosphere, in which the noosphere or anthroposphere of humanity is its part. The terrestrial environment that determines the existence of society/humanity on the planet is called ecology, and its spheres are called ecological.

The Cosmos environment is represented, first of all, by the cosmic luminary that defines the Earth and its biosphere, the Sun, as well as the Earth’s ionosphere and all its outer cosmic universe, in which Earth is only its microscopic part, the existence of which is completely determined by the cosmic whole and the laws of its evolution. If environmental spheres almost completely came under the influence (rather negative/destructive than positive/constructive) of society/humanity, then the cosmic sphere is only explored and is still far from its real influence. (Ecimovic, 2017).

The CYBS environmentalism adds to its internal 16 spherical societal clusters/elements another 5 external spherical natural/environmental clusters/elements. **They include four terrestrial, ecological spheres** (litho-, hydro-, atmo-, bio-) and one cosmic sphere integrated with the Sun. Together, these 5 spheres form the subject of CYBS spherical ecology, encompassing all the natural sciences that are included in the CYBS Megascience as its special cognitive cluster (below).

The concepts of 21 clusters/element of the CYBS object/subject as well as the concepts of their structure, interaction and evolution in social space/time, exhaust the fundamental layer of spheral linguistics in this integral science, on which the operational layer of its spheral language historically grows and modifies.

**3. Duplex/Binary Method of the CYBS Tetranet Thinking.** The utmost scale of the CYBS language, its integrity/complexity requires special attention to the simplicity and economy of its use. To do this, use the *Gandhica* “*Duplex/Binary Method of Linguistic Self-Organization of Tetranet Thinking*”, implemented by the pair use of the CYBS conceptual language through many duplexes of the *Gandhica* tetranet thinking categories. In duplexes of spheral linguistics, categories complement each other, outline the scale of wholeness and its extreme boundaries, or highlight its different meanings in synonymous situations, such as production/autopoiesis, etc. Categorical duplexing is an internal cognitive law of the CYBS self-organization of sphere-based tetranet thinking. In its spheral linguistics, it is represented by many categorical duplexes, which are lexically expressed through a slash (/).

They constitute the CYBS cognitology, which is distinguished by such advantages as economy/compactness of thinking units, their quantitative/mathematical expression in terms of spheral statistics and their structural modeling in **the matrix fractals** (below). CYBS cognitology integrates the qualitative and quantitative aspects of integrity/complexity thinking, providing it with fundamental scientific knowledge and wide access to digitalization (below).

**4. Spheral Statistics: the Holistic CYBS Unique Mathematical Advantage.** The spheral statistics (SS) includes traditional statistics (TS) and based on it. Both of them have their own logic of cognition and a paradigm of thinking. TS embodies the simplest and most accessible trend of empirical, inductive knowledge from parts to the whole. SS realizes the most complex and least accessible vector of theoretical, deductive knowledge from the whole to its fundamental, spheral parts, constituting its integrity. TS provides the SS theoretical spheral indices with empirical content/meaning. The SS classifies, compresses, organizes, and focuses the infinite and chaotic space of empirical indices of national statistics and their meanings. SS provides the technology of an ordered system composition/decomposition (aggregation/disaggregation) of the entire chaotic set of the TS indices. The advantages/limitations and the mutual complementarity of the two statistics are disclosed in detail in *Gandhica* (2019). Here we confine ourselves only to the merits of the SS and its key instrumental, mathematical and technological role in CYBS.

If the TS main advantage is its connection with reality, with the historical context in all its details, then the SS main advantage is its penetration into the eternal fundamental and deep/genetic laws/structures of integral humanity, which ensure its life, survival, stability in its entire history from the beginning to the end. SS grows out of the logical/theoretical premises of the spheres/spherons knowledge of social production common to

all countries and times. This allows the SS to become global/universal. At the same time, it cannot and does not seek to replace/supplant traditional statistics, which make up its nourishing empirical soil and source. The SS can only rely on it, contribute to its development and strengthening, and raise it to the level of fundamental science, while preserving all its necessary national characteristics. In the general methodological sense, the SS acts as a metalanguage and metalinguistics in relation to the TS object language and linguistics.

The SS emergence more than 40 years ago, its first steps and operations of composition and decomposition of indicators of two statistics are considered in a number of books (Semashko, 1992; 1999; 2002 and others, especially in *Gandhica*). Spherical statistics are statistics of spherical resources of PIOT, through which the statistics of spherical processes of PDEC, SIOT production spheres and SIOT spherons occupied in them are expressed. The spheron statistics (P) is the center of spherical statistics that defines peripheral/infrastructure spherical statistics. The foundation of spherical statistics is the basic matrix of spherical indices of PIOT 4x4 in size:

$$\begin{aligned} P1 + P2 + P3 + P4 \\ I1 + I2 + I3 + I4 \\ O1 + O2 + O3 + O4 \\ T1 + T2 + T3 + T4 \end{aligned}$$

On its basis, an almost infinite system of derivatives detailed fractal matrices of another dimension is constructed according to a simple algorithm:  $4 \times 4^n$ , where  $n$  is a series of natural numbers in modifications from +1, or from -1, or others. This matrix system is created on the alphanumeric indices of PIOT resource elements, called spherical indices. The algorithm of the infinite series of spherical matrices is the same: each row of any matrix turns into a column of the underlying matrix, and each row indicator appears in the underlying matrix as the sum of four indices expressing the complex of resources necessary and sufficient for its reproduction/autopoiesis.

The fractal spherical matrices are described by mathematical statistics and fractal mathematics by Benoit Mandelbrot (1982), in which “*a fractal is a structure consisting of parts that are in some sense similar to the whole*” expressing the ancient principle: “*all in all.*” The social structures of 20 spherical clusters/elements, as well as the matrices of their spherical indices are fractal, which makes holistic CYBS and its spherical tetranet thinking by fractal, subjected to the corresponding laws of fractal/statistical mathematics.

The system of infinite spherical/fractal matrices creates a logically unified network statistical space of humanity, the global mathematical digital language of which is able to integrate, compose and decompose according to the PIOT indices all the diversity of national statistics, overcoming their innate fragmentation, discontinuity and disharmony. Spherical statistics creates an adequate empirical basis for CYBS and opens the way for the fundamentally innovative “*Spherical Information and Statistical*

*Technology/Digitalization*" (SIST) of all spheres at all levels. The use of CYBS together with its SIST provides effective global harmonious governance of spherons in accordance with their values and priorities at all their levels.

In the framework of a single spherical statistics, its center is the statistics of spherons. Since each spherical element/cluster is associated with one or another part of spherons and doesn't exist without them acting as their actors, all of them (20) at any level can be expressed through spherical indices of spherons, through the quantity and quality of their employment, through its cost/time disclosed in the theory of spherical surplus cost of spherons, etc.

**5. CYBS as a Single Megascience of Humanity for its Spherical Third Way in the XXI Century.** Spherons as observable, observing and self-governing systems are the connecting center of cybernetics of all three of its orders, making third-order cybernetics of spheres/spherons their conscious and self-organizing beginning for its previous orders. Therefore, spherons are the center of the CYBS entire integral system as MegaScience of the 21<sup>st</sup> century (below).

The CYBS spherons make cybernetics, its "*mechanisms of communication and control in [social] systems, with... circular, feedback, or self-referential processes*" (Heylighen, 2020) extremely universal/complex, maximally holistic/large-scale and global science – MegaScience, covering the whole complex of observable and observing systems (first and second order), coinciding with humanity, since the spherons exhaust and embrace it.

The universal attributive/cognitive advantages of the spherical interpretation of complexity/wholeness in CYBS allow it to become a scientific, theoretical and methodological platform for combining all the countless social and humanitarian subdisciplines into a single holistic social Megascience of the XXI century. It provides a unified scientific solution to all global problems of humanity, ensuring its survival and liberation from all systemic crises of its integrity created by traditional, partial thinking, ignoring wholeness that is cognitively inaccessible to it.

CYBS is the connecting center of Megascience of the XXI century, providing a breakthrough in the humanity scientific knowledge, consciousness and thinking to a fundamentally new, substantial level of spheres/spherons genetic reality. The CYBS spheres/spherons unite all branches and all industry groups of the population; therefore, it becomes a unified platform for all industry disciplines of human cognition. All branch (social and natural) sciences in one way or another relate to and study a person and various partial groups/communities of people, which are all parts of universal spherons, whose cybernetics is studied by CYBS. It creates a unique historical opportunity to integrate all knowledge in hundreds of its modifications into a single scientific organism Megascience of the XXI century.

CYBS provides full and holistic interdisciplinary cooperation and the synergy of traditional sciences through bridges of spheres/spherons, over-

coming their discontinuity and raising them to a “*substantially new*” (Einstein) level of thinking unknown to them until now.

CYBS as Megascience will be a unique breakthrough of human knowledge in the XXI century that will free global society from all the problems that threaten its existence. But in this Megascience, the priorities of scientific knowledge are differently distributed than in the past. The cognitive priority in it is occupied by the social and human sciences, not in their traditionally stagnant and marginalized state but in the “*substantially new*” spherical state that they receive in CYBS. Their priority in relation to the natural and technical sciences allows them to control the quality of their use/influence both on society/humanity itself and on its spherical ecology. Their priority is realized by the brilliant Socrates testament of the cognitive priority of humanity, which has not yet been realized: “*Know thyself*,” which is achieved only with the discovery of spherons and the emergence on their basis of CYBS.

Similar Megascience excludes any existence of military science (of course, not immediately but from the moment of complete disarmament) designed to destroy people. But all useful military achievements for the peaceful life of humanity, of course, are preserved and integrated in the CYBS technical sciences complex.

**6. The True Level/‘Stature’ of Cybernetics: The Hidden Spheres/Spherons Science.** Fifty years ago (1972), the famous German philosopher Gotthard Gunter predicted the scientific perspective of Cybernetics: it “*will only attain its true stature if it recognises itself as the science that reaches out for that which is hidden.*” Cybernetics reached this level of true fundamental science in the CYBS, third-order Cybernetics of spheres/spherons, which (CYBS) reveals this “*hidden*”, genetic, societal, unknown to humankind “*substance*” (Einstein) of Cybernetics. This substance raises Cybernetics to the “*true stature [level/height of fundamental] science*” (Gunter) of spheres/spherons. Nothing other than the hidden, global spheres/spherons of humanity, truly/fundamentally scientific in Cybernetics does not exist. Therefore, only through them can Cybernetics in the Cyberspheronics face become the truly holistic, “*transdisciplinary and metadisciplinary*” (Scott, 2019) MegaScience of the new century.

The CYBS as the unified/holistic, interdisciplinary and transdisciplinary MegaScience reveals the true, fundamental genetic depth and hidden secret of humanity on Earth. The human/humanity has not yet known it as Socrates bequeathed, but humankind has already been opened to it by GHA’s intellectual efforts during 15 years and is presented in the first form, far from perfect, in our Spherons CYBS Manifesto.

**7. Humanity Spherical Third Way (STW) of the XXI Century and its Definition in CYBS.**

**7.1. General characteristic.** The Third Way as political thinking and movement originated in the last century and is represented by a wide range of ideological and party trends from fascist to liberal, the analysis of

which is devoted to many works (Giddens, 1998; Third Way, 1999; Fedotova, 2002; Greaney, 2016; and a lot others.). The Third Way is an attempt to find more effective methods and ways of responding to the new challenges of humanity, to which the traditional ideologies of capitalism/liberalism and communism/Marxism are powerless to answer due to their obsolescence and worthlessness.

The Third Way of Cyberspheronics is the “*SPHERAL Third Way*” (STW), an alternative from its traditional variants—European, American, and Russian—which we will combine with the concept of “*Traditional Third Way*” (TTW). Comparison of TTW and STW by basic attributes/qualities, free from unnecessary details, can be presented in the following table, which expresses their 22 key differences and the STW advantages.

Attributes/Qualities	Traditional Third Way (TTW)	SPHERAL Third Way (STW)
Attitude towards holistic humanity	Partial, reduced and fragmented on branches/corporations/nations; inadequate, deadly	Integral by holistic equal spheres/spherons that are exhaustive to humanity; adequate, viable
Human/humanity rights	Do not guarantee the fundamental right: the right to life, security and the absence of war/violence	Ensures the right to life, the absence of war/violence and all others rights and freedoms
World history, its vision	Total class struggle and eternal national wars of annihilation, capture and domination. Partiality/partons history	Harmony/peace/nonviolence and partnership of equal spherons. In their world history war/violence is only pathology of partiality/partons
World Order	Unipolar, monistic, subjugating the world to economic/military leader diktat, to systemic violence of its military political blocs	Multipolar, pluralistic, subordinate to balance harmony/nonviolence of humanity equal spherons and their partnership, hostile blocks free
Real priority	Economy, material wealth, financial capital, military-industrial complex	Social sphere, people, social capital, ecology, health, education, welfare of the population
Science/Ideology	Fragmented weak science devoid whole knowledge. Propaganda instead of science. Ideology priority. Refusal from global peace science. Concealment, closed truth. “Lie/false is God.”	Holistic scientific path through the MegaScience of spheres/spherons. No propaganda, only science. Global peace science – Cyberspheronics priority. Openness of truth. “Truth is God”: Gandhi
Peace education/literacy	Partial, unscientific, pacifist, sporadic, lacking in foundations of Global Peace Science (CYBS)	Holistic, free from the impotence of pacifism, universal on the Global Peace Science (CYBS) fundamental basis
Social equality	Impotence in the theory and practice of equality, leading to the growth of inequality constantly. Lack of scientifically recognized fundamental societal identity of equality	Scientific theory of equality in all dimensions based on the equality of spheres/spherons. Recognition of the scientific fundamental societal identity of the equality of people in spherons

Attributes/ Qualities	Traditional Third Way (TTW)	SPHERAL Third Way (STW)
Social contract of society as a whole and at each level	It is absent that is the cause of permanent group spontaneous conflicts, riots, hostility, violence and chaos. Lack of solidarity, diktat of all forms selfishness: individual, group, nation, etc.	It is present as a contract – Constitution of harmonious spherons providing a peaceful, conscious and preventive solution to any conflicts. Universal solidarity, the priority of altruism, empathy and compassion
Global peace	The complete inability to build peace that brought humanity to the nuclear eco-/geno-cide grave edge. Refusal from Peace Department	The full ability to build global peace on equality and harmony of spheres/spherons. Peace Department priority in a democracy
Non-violence	Total powerlessness in the theory and practice of non-violence: ultimate tool for conflict: violence	Full ability to ensure non-violence based on peace, equality and harmony of spheres/spherons
Disarmament	The question is not posed, arms race and militarism absolutization; nuclear disarmament is rejected	Harmonious disarmament in 50 years: transformation of national armies into a global peace/ecology corps; nuclear disarmament: nearest 10 years
Globalization	Unfair, in the interests of international corporations	Fair, spheral, in the interests of all spherons/humanity as a whole
Democracy	Partial democracy, in the oligarchic part interests. Population participation in elections: 25-35%, in decisions – 1-5%. Systemic pathologies: inequality, militarism, corruption, nationalism, racism, decline, nature destruction	Complete, in the interests of all spherons. Population participation in elections: 75>%, in decisions – to 50%. Long-term global overcoming of all systemic traditional pathologies/challenges
The structure of political power and strategic governance	Chaotic, spontaneous, sectoral, fragmented, different at different levels, subjective, subordinate to the ruling particular elite interests; short-term governance, within 5 years, no more	Systemic, integral, spheral at all levels, conscious, objective, subordinate to the interests of spherons, society as a whole; long-term governance up to 100 years, harmonized with short-term one
Law supremacy	Partial, limited laws of the ruling elites/partons in the interests of their power, but pathological for society as a whole	Holistic, spheral laws of spherons in the interests of society as a whole, taking into account the interests of all its parts in their harmony
Democratic Constitution	Of the partial dominant elites, their inequality and violence	Of the holistic and equal spherons, their peace, harmony, nonviolence
Mathematics	Virtually absent except for particulars	Spheral mathematical statistics, universal
Digitalization (innovation)	Weak, limited, partial, technical and surface	Strong, versatile and deep in spheral statistics – digital breakthrough
Pluralism and monism; Integrity and partial	Antagonistic monism and close to it devoid of measure traditional pluralism exclude integrity/holism, produce different types of the partial and its pathologies	Spheral, structural, four-dimensional pluralism admits, defines and produce viable integrity/holism, excluding the pathology of monism and the partial

Attributes/ Qualities	Traditional Third Way (TTW)	SPHERAL Third Way (STW)
The Future	"Sunset of Humanity", "The End of History", "The West Collapse", "The USA Fall",	The prosperity of humanity, the beginning of its mature history
Progress	Qualitative social stagnation amid rapid technological progress, social obesity	Qualitative social breakthrough along with prosperity in all progress vectors

**7.2. The STW Spherical Attributes.** TTW does not know the spherical structure of the population, its spherical employment and spherical social production, and is deprived of its science, although it sometimes uses the spherical terminology intuitively. STW, built on the fundamental science of CYBS, creates its consciousness on spheres/spherons, starting with the priority social sphere.

**1. The STW Sociosphere.** The basis of a civilized, open, fair and democratic society of the 21<sup>st</sup> century is equality, peace, non-violence and harmony of the spherons at all its levels, ensuring and guaranteeing human rights/freedoms, starting from the right to life and including the absence of war/violence and militarism at all levels society and power. The social priority is children and the harmonious development of the individual instead of the economy and militarism. Priority development of social infrastructure is housing, ecology, education, healthcare, sports, recreation, etc.

**2. The STW Infosphere.** The innovative priority of MegaScience of Cyberspheronics and its universal information technology is spherical statistics, spherical internet, spherical digitalization as a digital breakthrough, spherical artificial intelligence, spherical applications, etc.

**3. The STW Orgosphere.** Spherical democracy is a quota equality of elected representatives (including gender equality) of spherons for all governmental bodies at all levels; the combination of representative and participatory democracy; children's suffrage, executed by parents, to ensure social completeness and the participatory nature of democracy; and spherical decentralization of power.

**4. The STW Technosphere/Economics.** Spherical harmonious market, regulated by the STW priorities, is included in the priority of the sociosphere and ecology, along with the priority of average prosperity.

Capitalism and communism are alternative pathologies of the last century, as equally militaristic, disharmonious and deadly for humanity as extreme obesity and extreme exhaustion. The TTW does not constitute and is not viable. The only fundamental alternative is offered only by STW of CYBS in a holistic, non-violent, socio-economic system of human spheres/spherons. The CYBS is a holistic scientific and harmonious worldview of the spherons STW, alternative to all unscientific, antagonistic militaristic ideologies of the past.

**8. The CYBS Holistic System of Values/Human Rights.** It is determined by the societal role, qualities and priorities of the spherons, which provide all the conditions for the survival and stability of society/humani-



ty. It includes the following humanistic values/rights: life, love, peace, harmony, non-violence, truth, freedom, equality, fraternity, law, complete/truth democracy and happiness. This axiological system integrates humanistic human values/rights that are verified by long historical experience and excludes the opposite, anti-humanistic values practiced by violent and totalitarian empires: death, hatred, war, disharmony, violence, lies, slavery, inequality, enmity, arbitrariness, dictatorship, misfortune and its vicious derivatives. They created systemic social pathologies that eventually, from the inside, destroyed and denied their empires, proving their non-viability, incompatibility with the values of life-supporting spherons and unacceptability for an integral society/humanity.

The spherons axiological system is based on the priority right of human/humanity to life/peace, excluding war/militarism, as detailed in the relevant GHA Declaration (Semashko, 2017).

**9. Spherons: Social Priorities Hierarchy/Network.** Spherons/people have the highest priority of wholeness as only this societal resource creates/produces all of them (PIOT), including itself, i.e. all societal integrity in its entirety and complexity. Spherons fully determine the existence/autopoiesis of society/humanity, but they can only do this through other spherical resources created by them. Therefore, the absence of any of them makes the existence of benevolent society/humanity impossible, therefore they are **equally** necessary for it. Therefore, spherons are equal in power, in the possession, use and governance of all spherical and natural resources.

This is **the spherons highest law of organizational/managerial equality**, which ensures/determines the social equality of other forms and begins to consciously act in society only with its scientific knowledge in the CYBS and with its constitutional fixation at all levels of democratic power. It provides a quota equal distribution of all power equally among elected representatives of spherons.

The spherons priority determines among people the **priority of children**, the quality of which determines the quality of society as a whole, including the highest quality of attitude toward the older generation, who gave birth, raised and reared grateful children. Their priority is ensured by the "**Children's Suffrage Executed by Parents**" (Semashko, 2004).

The spherons priority determines the **full gender equality and partnership** (Eisler, 1994), the full gender balance of power as the most optimal condition for social autopoiesis in general and its governance at all levels.

All of these societal priorities determine and create all the real conditions for **the first humanistic holistic priority** of the comprehensive and harmonious development of each individual. This was proclaimed, but never achieved in the past as a result of the dominance of other priorities: inequality, violence, power, profit, etc. This is the whole hierarchy/network of the spherons social priorities.

**10. The Ineradicable Vice of Traditional Governance/Authority/Democracy.** *In all centuries and millennia, it has always been built on the dominance/priority of one or another of the most powerful (economic, political, spiri-*

tual or social) parts of society over its whole. This key/structural flaw of partial control gives rise to all its other fundamental and irremovable flaws in history: inequality of all kinds, violence, militarism, corruption, selfishness of all forms and injustice. Such partial/egoistic control/power was successful, at best, only in solving partial problems, but it remained ineffective/destructive with respect to the whole and inevitably led it to death along with its dominant partial power. Global problems created by partial power/administration, including any democracy, are insoluble for TTW, which was noted by Einstein 70 years ago (below) and proved the unsuccessful historical experience of solving these problems. The most striking example of the last century is the powerlessness of democracy in regard to nuclear weapons, the race of which it generously finances; only accelerating the approach of humanity to the global genocide/ecocide, reducing the probability of its survival to a minimum, to 100 seconds (Mecklin, 2020). The traditional governance of the ruling political systems is aimed at strengthening the interests of one of its parts (class, party, elite, etc.) to the detriment and expense of the whole interests. It mistakenly defines this part as the generative principle of the whole, which deforms it and leads it to inevitable death.

**11. The Cyberspheronics (CYBS) Mission: Holistic/Spherical Democracy for the Spherical Third Way.** *The CYBS first social need and mission is to reorganize the democratic way of self-government in the interests of society as a whole at all levels from local to global, in order to ensure its survival/sustainability by eliminating the root vice of traditional power. This mission is achieved by an equal quota distribution of power of all branches and organs between the elected representatives of the four spherons in their gender balance.*

Cyberspheronics is the necessary holistic scientific thinking/consciousness/knowledge of spherons, transforming them from a spontaneous, unconscious “actor in oneself” into a conscious, scientifically minded democratic “actor for oneself”, expressing by Kant terms. Therefore, spherons and Cyberspheronics are inseparable from each other in their true mutual necessity/sufficiency as a necessary, integral actor/subject and its integral consciousness/thinking. CYBS is the scientific strategy of STW of the 21<sup>st</sup> century, acceptable to all peoples in their quest for peace, harmony, non-violence and prosperity.

*Cyberspheronics is not “EGO thinking/governance” of a selfish/partial nation, party or person, leading to self-destruction of humanity/noosphere, but “ECO thinking/governance” of its survival and prosperity on Earth. This is its mission.*

**12. The CYBS History.** Cyberspheronics (CYBS) has come a long and complex evolutionary path, starting in 1992 with the first fundamental book *Spherical Approach* (Semashko), devoted to spheres/spherons (societal groups of the population engaged in the spheres of social production/autopoiesis, where they are also called the traditional term “spherical classes”) and their spherical statistics. Its next step was *Tetrasociology*, which received the support of RC51 Sociocybernetics (Semashko, 2002; Scott, 2002).

CYBS develops and enriches the initial fundamental ideas of the cybernetics founders: Norbert Wiener, William Ashby, Heinz Foerster, David Stuart, Gregory Bateson, Warren McCulloch, Gordon Pask, Robert Park, Stafford Beer, Umberto Maturana and many others. These ideas received a new incentive for development and special significance in the works on Sociocybernetics, concentrated in the corresponding Research Committee (PC51) of the ISA, since its establishment in 1998, as well as in international cybernetics societies, which is reflected in the historical works of Bernard Scott (1983 – 2019).

The stratum/trend of cybernetic knowledge is organically integrated into CYBS with the trend of macro-sociological generalization and development of the four-spherical structure of social production as a whole (autopoiesis according to Maturana) in theoretical sociology. It starts with the early Marx, Danilevsky, Kovalevsky, Gandhi, Sorokin, Braudel, Parsons, Toffler, Bourdieu, including Semashko's books for 30 years, starting with *Spherical Approach* (1992) and ending with *Gandhica* (2019) and many other sociologists.

The concept of “*Third Order Sociocybernetics*” of spheres and spherons was first introduced with the participation of Bernard Scott in the GHA collective book “*The ABC of Harmony*” (2012).

**13. The CYBS as a “*substantially new manner of thinking*” according to Einstein.** The CYBS conception/paradigm implements the Albert Einstein great testament more than 70 years ago for the humanity survival, which has not been fulfilled so far. He wrote: “*The significant problems we face cannot be solved at the same level of thinking we were at when we created them.*” Therefore, “*we shall require a substantially new [holistic and nonviolent, asymmetric] manner of thinking if mankind is to survive.*” Unfortunately, over 70 years, humanity was unable to find, define and practically use “*substantially new thinking*” for its survival.

Einstein admitted the possibility of “*a world government*” only based on such “*substantially new thinking*” but not on the basis of traditional, torn, partial and militaristic thinking that deprives humanity of survival, unity and solidarity. The CYBS thinking of wholeness/complexity by categorical duplexes of spheres/spherons in structural matrix modeling can be called the 21<sup>st</sup> century cognitive Copernican revolution and a breakthrough from the intellectual impasse of past centuries.

**14. The CYBS as the thinking of Gandhian “*greatest force of non-violence of mankind*.”** The CYBS theory continues and develops at a new scientific level the greatest discovery and practice of Mahatma Gandhi's non-violence through the use of his “*Newtonian law of the greatest force of mankind non-violence*” in his varnas/spherons. Gandhi, analyzing “*the whole gamut of man's activities ... [as] an indivisible whole*”, wrote that it represents the indivisible unity of four **equally** necessary and sufficient spheres of society: “*social, economic, political and purely religious*”. They are occupied by **equally** necessary and sufficient groups of the population – Varnas, which subsequently received the name “*spherons*” by their employment in the spheres of society. “***All [four] varnas [spherons] are***

**equal, for the community depends no less on one than on another,”** therefore they are equally necessary and sufficient together, determining the systems wholeness of every society.

*“Varna is not a human invention, but an immutable law of nature—the statement of [genetic] tendency **that is ever present and at work like Newton’s law of gravitation.** Just as the law of gravitation existed even before it was discovered, so did the law of varna... Varna, thus conceived, is no manmade institution but the law of life universally **governing the human family.** Fulfillment of the law would make life livable, would spread peace and content, end all clashes and conflicts, [and] put an end to starvation and pauperization... The idea of superiority or inferiority is wholly repugnant to it [varna]. Though **the law of varna** is a special discovery of some Hindu seer, **it has universal application...** Varna has **nothing to do with caste.** Down with the monster of caste that masquerades in the guise of varna... That is how I look at the law of varna. The world may ignore it today **but it will have to accept it in the time to come.** It ordains that everyone shall fulfill the law of one’s being... Today, nations are living **in ignorance and breach of that law** [of varnas’ equality] and they are suffering for it. The so-called civilized nations have by no means reached a state [of varnas development], which they can at all regard with equanimity... Without the abolition of the caste hierarchy, **there can be no peace in society and the world** ... When we revive universal human equality [of varnas/spherons]... When that day comes we shall have peace on earth and goodwill to men.”* (Gandhi, 140–183).

**14.1. The CYBS: Synergy of the Holistic Potentials of Gandhi, Wiener, Einstein, Maturana, Vernadsky and Kelso Based on Spherons.** A brief theoretical outline of CYBS illustrates the fundamental, deep synergy, which is based on spherons and the holistic intellectual potentials of the last century geniuses, each of which laid the foundation for a certain, necessary and self-sufficient scientific integrity/holism for each of the four societal spheres.

**Gandhi** is the foundation of the first definition of the societal integrity/wholeness of non-violence for people/humanity.

**Wiener** is credited with the first definition of universal governing circular integrity/wholeness, including the governance/organization of a human society.

**Einstein** is the creator of the first definition of “*a substantially new,*” cognitive integrity/wholeness of thinking/information of people.

**Maturana** gives the first fundamental definition of autopoiesis (self-production), common to the entire biosphere, including society, where it acts as a conscious social production, i.e. societal autopoiesis.

**Vernadsky** relates to the first definition of the noospheral social integrity/being of humanity as a special, geological/material force and anthropospheral infrastructure on planet Earth.

**Kelso** gives the first definition of the universal holism of the “binary economy”, which complements the societal equality of Gandhi’s spherons

with “*equality of economic opportunities through ownership of capital*” (Kelso, 1968), which he implemented in the “*Employee Share Ownership Plan* (ESOP)” with direct and reverse ownership. The economic holism of Kelso/Kurland ensures the prevention and peaceful harmonious resolution of all economic conflicts, opening the “*Just Third Way*” of socio-economic development and converging with the Gandhian economy of “*love, equality, justice and non-violence*” of the spherons.

CYBS, on the basis of statistically and empirically proven spherons, the intuition of which is present in all the named geniuses of the last century, in the potential of each, synergistically integrates/synthesizes all the fundamental potentials of the integrity of the last century. On their synergy, CYBS forms the science of a fundamentally new, holistic, integral, meta-, trans- and inter-disciplinary class of the XXI century: MegaScience (above). They are synergized only on the basis of spherons and only within the framework of Cyberspheronics as the highest level of organizational/governing cybernetics. CYBS provides them with synergistic, cognitive/praxiological integration/holism in MegaScience pragmatics (below). CYBS stands on the shoulders of these intellectual giants, ensuring the highest scientific fundamentality and integrity of its MegaScience, constructing and constituting it on their fundamentality, ensuring the non-violent achievement of all the goals of global peace and the eradication of all wars/militarism.

**15. The CYBS Social Need.** Its acuteness is set, on the one hand, by the high level of globalization of all spheres of world social production, which determines the decisive role of its integrity and global governance of it; and, on the other hand, by the systemic impotence of traditional partial social science, torn into hundreds of industry disciplines, to solve global integrity problems. This systemic weakness is demonstrated by the entire crisis situation associated with the COVID-19 pandemic at all levels: global, regional – the destruction/crisis of the EU solidarity, national – the crisis of separate countries, especially the USA, etc.

The CYBS offers a constructive alternative to systemic national impotence by its systemic “*greatest force of non-violence*” of humanity spherons (Gandhi), self-organized in their spherical structures of global governance, the first project of which for the UN was created in the GHA in 2017 (Semashko). The priority development of this alternative at the international level fully meets the constantly exacerbating social needs of humanity inherent in CYBS, which today does not have any other scientific competitive alternatives.

CYBS creates and provides in the XXI century “*cybernetic consciousness as a new noospheric phenomenon of the global information space*” (Tonkonogov, 2018).

**16. The CYBS Dual, Peaceful/Military Use.** In the transition period, until the completion of complete and general disarmament, there remains a dangerous possibility of militaristic use of the CYBS by one or another country or group of countries in order to achieve world domination by non-violent means. Any fundamental science, as

we know, has a dual, peaceful/military purpose. CYBS is no exception from this danger.

**17. International Monitoring of the CYBS MegaScience Development/Use.** There can be two effective and compatible/complementary ways to control the CYBS development/use and, thus, preventing its militaristic use in the “*national egoistic interests*” of the most powerful countries or their blocks, as was the case, for example, with atomic energy in 1945 and subsequent years.

17.1. The creation of a single “*Global Academy of CYBS MegaScience*” (GACM) with regional and national branches under the auspices of the UN/UNESCO or the International Bank and the IMF, capable to finance the **CYBS MegaScience** project and exercising international control over it. The GACM will be an excellent example of international scientific and humanitarian cooperation.

17.2. The establishment within the framework of world civil society of the “*International Association of Cyberspheronics*” (IAC), uniting, on the one hand, international associations of scientists, primarily in cybernetics, such as the *American Society for Cybernetics* (ASC, 1964), *World Organization for Systems and Cybernetics* (WOSC, 1969), *ISA Sociocybernetics* (RC51, 1998), *The International Academy for Systems and Cybernetic Sciences* (IASCYS, 2016), and others such as that; and, on the other, the leading peacemaking organizations ICAN, NAPF, IPRA, IPPNW, UN2020 and the like. They are able to effectively continue the initial international development of CYBS, which was carried out in the GHA for 15 years, and better and faster than others to assess the scientific and humanitarian value of CYBS, because they are aimed not at the military, but at the peaceful development of cybernetic science and humanity. The wider CYBS will be involved in international scientific and public control, the less will be the chances of its militaristic and destructive use.

**18. The CYBS Projects National Experimental Verification.** The international bodies of GACM and IAC will ensure wide international verification of each CYBS project in the specific conditions of separate countries and regions as well as in the respective national universities and academies of sciences. This will facilitate integration of the CYBS projects into separate countries and will raise the level of each national science to the highest level of **global Cyberspheronics MegaScience**. To this goal, these bodies create in different countries a network of the **CYBS International Research Centers/Laboratories** (IRCLs), which will provide scientific and social experimental testing of CYBS projects, especially those previously created by the GHA with their necessary modernization.

**19. The CYBS Manifesto: Humanity True Self-knowledge Beginning.** The CYBS Manifesto is a manifesto of the scientific worldview/consciousness of the humanity spherons, i.e. humanity as a whole. Humanity did not know such self-awareness yet. **Only in its cybernetic form did human consciousness find its adequate, holistic expression.** This became possible only at the beginning of the XXI century; it did not work out before. Therefore, the CYBS/Spherons Manifesto is only the first, modest, and far-from-perfect be-

ginning of the scientific self-consciousness of humanity. It will inevitably expand, correct, deepen and develop in all directions throughout the subsequent evolution/history of human/humanity, as long as it exists. The human self-knowledge, whose priority was bequeathed by Socrates more than 2000 years ago, in the Cyberspheronics true fullness and depth of the spherical societal genetics of its spherons, begins in the XXI century, more than four thousand years after it.

**20. The CYBS Truth Three Simple Conditions/Steps.** For more than 40 years of CYBS's difficult development, CYBS has accumulated vast experience in verification and individual conviction in its truth, which is integrated in three simple actions/steps available to every literate person, especially to every open-minded, honest and true scientist.

**First step.** Carefully read the integral and integral/crowning book of CYBS *Gandhica* (2019), created within the GHA by 82 coauthors from 25 countries based on numerous scientific researches and publications over the past 40 years. Recall that the proposed CYBS Manifesto is nothing more than the multidimensional focus of *Gandhica* and its quintessence.

**Second step.** Write a review of this book with an assessment of its scientific, methodological, social and political significance for humanity and the development of its knowledge, which becomes most vivid in comparison with the traditional paradigms of classical and post-non-classical science. This review, which is publicly available, will be a measure of the intelligence, depth and quality of the CYBS and will increase the understanding of each reviewer.

**Third step.** Complete a Statistical Scientific Research of Spherons (SSRS) of any city, institution, region, country according to the example of their statistical studies of 76 countries in *Gandhica* and the choice of available statistics for any period of time, for example, for the past year: 2019, 2018, 2017, etc. Only through an individual, independent SSRS is intellectual possession of the societal substance/reality of sociogenetic cybernetic spherons possible.

Over the decades of SSRS in the GHA and before, CYBS's methodology/technique was found and tested and simplified. It is presented in the book *Gandhica*, in Chapter 1, in three small paragraphs: 1.4.2., 1.4.3., and 1.4.4., on 5 pages: 32–37 ([https://peacefromharmony.org/?-cat=en\\_c&key=848](https://peacefromharmony.org/?-cat=en_c&key=848)). Any SSRS using this technique, resulting in 8 spherical indices per half page in the elementary statistical table, will require, as experience has shown, **no more than 4 hours from its executor**. Moreover, half of this time will take mastery of the technique and search for statistics on the Internet. You can compare and add your table to the tables of spherons of other countries and cities in *Gandhica*. Then these tables can be collected and published in a special book, "*The CYBS Statistics*," which can be produced annually both at the UN global level and at the national level. These statistics will demonstrate the dynamics of global and national spherons as the primary empirical basis for all other cybernetic studies. Similar SSRS will be massively accessible, starting with 5<sup>th</sup> grade

students, when its methodology becomes a smartphones application (see below) and will ensure universal cyber literacy in CYBS in the XXI century. The professional cyberneticians can and should start/launch this necessary and inevitable literacy. Without knowledge of spherons through SSRS, there can be no Cyberspheronics as MegaScience; there can be no **“substantially new manner of thinking”**; there can be no mastery of the **“greatest force of non-violence”**; there cannot be implementation of CYBS in any practical project.

## VI. Cyberspheronics Pragmatics. The Best Global Security is Global Peace

### **1. The CYBS Pragmatics/Praxeology and its Economic Efficiency.**

The CYBS pragmatics always accompanied its theory from the very beginning, more than 40 years ago, starting with its first practice at the *Demurge* student club in 1976–1980. The CYBS highest practical goal is to ensure humanity’s survival and save the noosphere from the global ecocide/genocide in the XXI century. We can name at least six fundamental innovations of CYBS, which will ensure the achievement of this pragmatic goal based on its spherical statistics and technology.

1.1. The development of spherical statistics and CYBS technology will require the creation of new research centers and laboratories in each country with millions of new, highly intellectual jobs and the corresponding innovative information infrastructure. National and international statistical agencies are the most prosperous and interested institutions in the development of spherical statistics.

1.2. CYBS and its digital technologies will ensure the creation of a spherical Internet, which will put the traditional Internet under control, overcoming its spontaneity, fragmentation, destructiveness and other well-known limitations and vices thereof.

1.3. CYBS and its digital technologies will provide a development trend for a new, spherical artificial intelligence (SAI), which integrates the achievements of traditional AI and provides control over its further development to exclude any threats to humanity’s survival.

1.4. CYBS and its digital technologies will provide a theoretical and information platform for a new, non-violent democracy that excludes war, violence, militarism and the arms race. This democracy will be able to establish itself, with appropriate mass enlightenment/education and strategic global governance training, over the next 50 years or by the end of the XXI century, as the GHA studies have shown (GPS, 2016; Gandhica, 2019; etc.).

1.5. CYBS and its digital technologies show the only cardinal way to solve the global environmental problem: overcoming global warming and establishing a harmonious and sustainable spherical balance between nature and humanity through control and global governance of interactions between their spheres.



1.6. CYBS and its digital technologies open up the production of an almost unlimited class of applications for individual smartphones of two key varieties. A) For planning/managing the spherical resources of individual autopoiesis within the different periods of its life time space, starting, from the age of 10, with a view to the most promising and successful personal growth, and harmonious development. B) For leaders of any rank and organization of any scale for individual design, comparison and selection of the most optimal development strategies for these organizations through the harmonization of their spheres/spherons. Any similar application for an individual smartphone is a pocket-sized artificial intelligence (PAI) device of the highest level as an indispensable tool for any thinking individual who cares about the most effective development of both his own personality and the organization he or she leads. The PAI will ensure the interaction of AI and humans at all levels of a cybernetic society (Tonkonogov, 2018).

The PAI applications along with other CYBS pragmatics create a new market of CYBS digital spherical technologies, unlimited in time, demand and variety, which will endlessly pay for any starting investments in them.

These and many other CYBS innovations, private and derivative from them, provide a breakthrough for business and global governance in this direction to a qualitatively different level of business/pragmatic, social and economic efficiency.

**2. The CYBS Projects Total Number.** For more than 40 years of CYBS, there have been about 300 industry and regional projects in all spheres and at different levels. These projects started since the spherons structure was first tested in the student club of harmonious development “*Demiurge*” in 1976 –1980 (Semashko, 2017). The projects were first politically tested in the “*Spherical Democracy Faction*” in the St. Petersburg first democratic Parliament, “*Petrosoviet*”, in 1992 –1993 (Semashko, 2010). The lists of similar projects are published in many GHA books listed in the bibliography. A complete list of the projects will be published in the GHA 10<sup>th</sup> book in this year end.

**3. The Most Ambitious and Fundamental CYBS Project: “The UN Harmony Spherical Model”.** This project was created by the GHA in 2017 to participate in the projects contest of the Swedish “*Global Governance Foundation*”. “*The UN Harmony Spherons Structure*” (Semashko, 2017), presented below, summarizes this project. This model assumes that each United Nations state-member has 8 national emissaries in the UN (in gender balance by 2 representatives from each of the four national spheres), which would amount to 1,600 members of its General Assembly for 200 UN state-members. It could democratically fulfill the functions of “a world government” (Einstein), providing global peace from spherons harmony at all levels from municipal to global.

## The UN Harmony Spherons Structure (GHA, 2017)

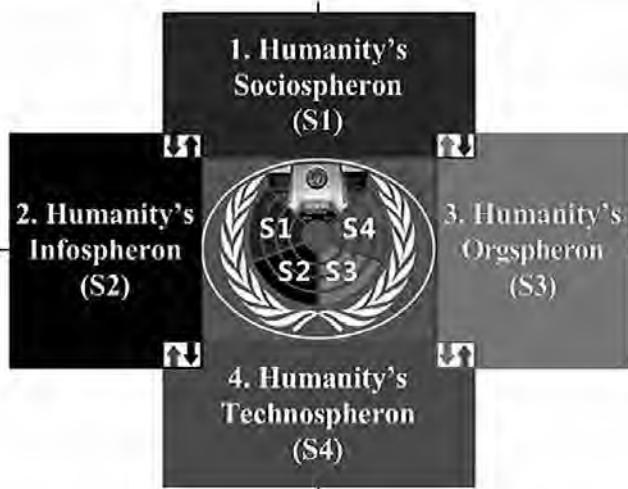

[https://www.peacefromharmony.org/?cat=en\\_c&key=769](https://www.peacefromharmony.org/?cat=en_c&key=769)

The type of this model creates at all governing levels and in all structural units of both a sectoral/branch and regional nature the spherical structures. Examples of many of them are presented in the list of CYBS projects.

**4. Holistic MegaScience: Full Social Responsibility.** Through holistic Cyberspheronics/Megascience, for the first time in history, humanity will receive such scientific knowledge that it will be able to take and bear full scientific social responsibility for the quality of all autopoietic structures and processes of humankind/noosphere, ensuring its survival and prosperity for all people. In contrast to the rupture of traditional scientific knowledge/thinking in hundreds of partial “subdisciplines” devoid of a unifying cybernetic platform of spheres/spherons, whose social responsibility was practically zero for 75 years, when the threat of a global nuclear ecocide/genocide arose, **CYBS for the first time opens such an opportunity of world/universal responsibility for all of humanity.** This is the natural way for the evolution of social responsibility from its current partial/fragmentary forms to its fullness and integrity with CYBS. The historical path of evolution of social responsibility is considered in detail in the writings of Matjaž Mulej (2016, 2019 and others) and his Institute for Social Responsibility. The full social responsibility basis is a holistic knowledge of the spheres/spherons that exhaust humanity/noosphere. Without their knowledge, all liability is flawed and limited.

**5. Holistic Cybernetic Megascience: Global Democratic Federation and World Government Foundation.** The long and difficult way to search for a democratic federal structure of both multinational countries

and the Earth global democratic federation, devoid of a fundamental scientific abutment in the past, becomes fulfilled in the spheres/spherons of Cyberspheronics as a holistic Megascience of humanity. The conscious organization of the social life and political power of each people/nation and humanity as a whole on the basis of spheres/spherons of the appropriate scale, level and cultural-historical diversity, disclosed in the CYBS, creates a fundamentally substantiated single platform for the Earth global democratic federation at all levels from municipal to world, as confirmed by holistic cybernetic science. At the same time, the CYBS becomes a fundamental scientific pillar of the world government (Einstein), the world parliament and the Earth's Constitution. CYBS also becomes a fundamentally new peacemaking tool than can save humanity of all sorts of wars, according to the UN and its corresponding Security Council and its Charter (Kotila, 2016 and others; Martin, 2018, etc.). The spherons equality is the social foundation/law of scientific federalism and its Constitution, without which they (democracy, federalism and their constitutions) remain shaky and unstable, from within which fascist and other totalitarian regimes easily arise, as history has shown many times.

**6. Holistic Cybernetic MegaScience as a Common Scientific Platform for the Integration of Various Environmental Projects.** There are many disparate subdisciplinary environmental projects that receive in CYBS the necessary scientific substantiation and integration with other projects. This fully applies to Pawlick's original project "*Fungi Future – Biosphere Rescue Plan*" (2020).

**7. Spherons Manifesto as the Manifesto of the Norm Replacing the Humanity Pathologies.** Humanity/society, as a social organism of the highest complexity, has its own norm and pathologies. Their knowledge requires fundamental science, to which humanity has not yet matured and is only entering its first stage creating it in the MegaScience of Cyberspheronics. CYBS, penetrating into the spherons' genetic level of humanity, offers fundamental scientific knowledge of the social norms of love, harmony, peace and non-violence. Only this genetic societal norm provides humanity with continuous reproduction, uninterrupted life, survival and prosperity. The spherons in love, harmony, non-violence and peace constitute the only internal source of their being, with all its infinite historical, cultural and civilizational diversity. Spherons are the source of human health and beneficial norms.

The source of social pathologies/diseases of humankind, whether mild or severe, are deviations from the norm. These deviations have occurred at various historical stages among various, historical transient parts/partons of humanity: nations, classes, groups, parties, elites, states, etc. They give rise to certain social pathologies that often reach extreme ugliness. They are different in duration, severity, acuity and depth of flow: nationalism, chauvinism, fascism, racism, anarchism, Marxism, liberalism, fundamentalism, bureaucracy, vandalism, imperialism, militarism, exceptionalism, destructivism (of all forms and types), terrorism, mis-

anthropism, sadism, selfishness, radicalism, alcoholism and the like. The scientific atlas/encyclopedia of social pathologies has not yet been compiled due to the lack of science, but CYBS creates the basis for it, both as a whole for humanity and in its spheres/spherons, as well as in different historical eras. This is a matter for the future.

It is important to emphasize that different forces can use knowledge of social pathological anatomy for different purposes: to cure any social organism, to kill it as soon as possible, or to exacerbate pathology. Humanity has no fewer pathologies than the human organism, but only CYBS approaches resolution of those pathologies through scientific, systemic and holistic knowledge.

**8. Summary. The CYBS Manifesto: The Manifesto of Humanity Spherons Third Way, Outside of Capitalism/Communism.** Cyberspheronics (CYBS) finds in the equal, structurally eternal and universal spheres/spherons of humanity its deepest societal genetic nature of its wholeness. Cyberspheronics provides humanity and the planet with survival in the framework of a harmoniously organized spherical social auto-poiesis, subject to the laws of sustainable ecology. Cyberspheronics frees humanity from the global nuclear ecocide/genocide. We discuss this issue in detail and with the necessary justification in *Gandhica* (Conclusion).

Therefore, the CYBS Manifesto is the Manifesto of humanity's survival, its holistic harmonious worldview, alternative to all partial, monistic and destructive ideologies of the past. This is Manifesto of the genetically equal spherons and their conscious/scientific, "*substantially new*" **Third Way** to the era of peace, love, harmony and non-violence. The science of self-knowledge of humanity is finally reached the values of this era, following in the footsteps of Gandhi.

The CYBS Manifesto is an alternative to all past Manifestos of violence, including communism and liberalisms (Oxford, 1997). In place of various architectures/dictatorships of the deadly parts of humanity of different colors (white, black, red, green, rainbow, etc.), the CYBS Manifesto creates a fundamental scientific architecture/democracy of non-violence by equally necessary and sufficient spheres/spherons of humanity/noosphere as a whole. The CYBS guarantees humanity equality, justice, peace, love, brotherhood, freedom, non-violence and happiness of all peoples in their harmony while also retaining all constructive achievements of the past.

No matter how brutal the resistance of the dominant parts of any color is, the victory of the new world order architecture, based on the foundation of a holistic cybernetic MegaScience of spheres/spherons, is inevitable in the 21<sup>st</sup> century. Mahatma Gandhi first predicted non-violent victory almost a century ago. Therefore, the CYBS Manifesto is the Gandhian Manifesto of the Future and its New Generations. It is the spherons' Manifesto of love, harmony, peace and non-violence for an evolving mature reasonable humanity.

VII. ICAN/GHA Epilogue. Citizens of the Earth!

We, the ICAN/GHA, propose the **Anti-Nuclear Manifesto** for the salvation of humanity from the all-consuming suicidal/genocidal nuclear fire, first tested 75 years ago on peace civilians in Hiroshima/Nagasaki, 250 thousand of whom were easily alive burned in it.

For 75 years, nuclear weapons, through the efforts of the traditional human reason, have been brought to such a degree of suicidal/genocidal perfection that now they are capable to burn all of humanity together with the planet easily and quickly, with a supersonic speed of their delivery to any planet point and to any corner of our common at home.

The traditional mind for 75 years was only able to burn itself, but was powerless to save and preserve itself. Einstein understood and expressed this then, demanding “**a substantially new manner of thinking if humanity wants to survive.**” For 75 years it has become clear that with traditional thinking humanity cannot survive. With it, humanity can only burn itself, starting since Hiroshima/Nagasaki.

Even earlier, Gandhi found a way of thinking of the “**greatest force of non-violence**” by the spheres/spherons of humanity, which “**is mightier than the mightiest [nuclear] weapon of destruction.**” But for traditional thinking was not 75 years enough to recognize and master the salutary, “**substantially new thinking**” by the spheres/spherons, which are the only ones that possess soft nuclear energy of the “**greatest force of non-violence**” within humanity. It is inaccessible to traditional thinking.

Citizens of the Earth!

The conclusion of our **Manifesto** is simple. If you/we want to survive by eliminating suicidal/genocidal all-consuming nuclear fire, you must rise to a “**substantially new manner of thinking**” by the Gandhian spheres/spherons. It was first systematically developed in the innovative cyber science Cyberspheronics in our Manifesto, as a result of intellectual searches and work for many decades. A new, spherical way of thinking in it compressed in synergy of the cognitive laws highest intellectual achievements of the humanity greatest geniuses: Gandhi, Einstein, Wiener and others on 40 pages. Its semantic space for the humanity survival is enclosed between its two centers/poles of synergy: the Nobel Appeal, which sets the strategic goals of survival, and the system of cognitive laws of Cyberspheronics that ensure their achievement in a new paradigm of thinking. There is no other paradigm of it.

Therefore, there is no other modus of survival and other way out of the suicidal/genocidal nuclear deadlock in us, in humanity, **except for a substantially new manner of thinking by the spheres/spherons of our Manifesto.** It was created by 25 co-authors from 14 countries and is based on hundreds of the co-authors’ works of previous years ... (It is in the attachment, 40 pages and is published on the website along with all responses: [https://peacefromharmony.org/?cat=en\\_c&key=908](https://peacefromharmony.org/?cat=en_c&key=908)).

This is where our survival and salvation lies. To do this, we all need to understand, study, recognize and together, in solidarity and partnership, without confrontation, develop, improve and practically apply this saving manner of thinking.

This is our conclusion and call to forever exclude any possibility of a repetition of the horrific tragedy of Hiroshima and Nagasaki through 75 years!

Yours sincerely,

**Beatrice Fihn,**

ICAN Executive Director, Sweden,

ICAN is Nobel Peace Laureate 2017,

[https://peacefromharmony.org/?cat=en\\_c&key=943](https://peacefromharmony.org/?cat=en_c&key=943)

Email: [admin@icanw.org](mailto:admin@icanw.org)

**Leo Semashko\*, PhD,**

Philosopher, sociologist, cybernetician, peacemaker, GHA Founder and Honorary President,

The ISA RC51 Sociocybernetics Honourary Lifetime Member,

Initiator and Editor-in-Chief of the "*Peace/Cyberspheronics Manifesto*",

Blog: [https://peacefromharmony.org/?cat=en\\_c&key=253](https://peacefromharmony.org/?cat=en_c&key=253)

Email: [leo.semashko@gmail.com](mailto:leo.semashko@gmail.com)

Skype: leo.semashko

Phone home: 7-812-597-6571

25-09-20

\* The cybernetic ideas presented in this *Manifesto* and *Gandhica* grew up in close cooperation and friendship with Bernard Scott, a well-known British cybernetics for the past 20 years, including 15 years in the GHA (Global Harmony Association: International peacemaking organization of scholars-humanities, established in 2005: <https://peacefromharmony.org>). His fundamental ideas are important intellectual contribution to this *Manifesto*. The main milestones of our cooperation over 20 years are presented on the GHA website. I cannot forget their and am happy to express to him my highest appreciation and gratitude. Leo Semashko. May 31, 2020.

## VIII Appendixes

**"*The Anti-Nuclear Manifesto*" Final Formula: The Humanity Gandhian**

Evolution Cognitive Pragmatics. Leo Semashko

**"*The Anti-Nuclear Manifesto*" final formula definition within the humanity Gandhian evolution cognitive pragmatics:**

From the Gandhian intuition of varnas as reality/actors of nonviolence in the ancient India, through partial/fragmentary knowledge of partons as reality/actors of violence in the Western civilization to holistic scientific knowledge of Gandhian spherons as reality/actors of nonviolence in the global harmonious civilization, societal knowledge of which begins since 21st century from the pragmatic "***Anti-Nuclear Manifesto***".

**It defines the Gandhian spherons** as a key cognitive condition for the practical liberation of humanity from the absolute evil of nuclear weapons, which embody the extreme destructive/genocidal scale of violence.

**It defines the Gandhian spherons** as the first real background to exclude nuclear weapons and to build a system of global security/peace as a non-violent civilization of humanity without war/violence with the realm of harmony, peace, love, truth, freedom, equality, brotherhood, nonviolent Gandhian democracy, justice and prosperity for all nations of the planet.

**The elimination of nuclear weapons from the life of humanity** is its fundamental, system, civilizational shift, restoring its societal vital genetics and nature, laid down by God, and not a partial, technical improvement of a dying, exhausted itself, violent civilization. Therefore, the eradication of nuclear weapons as a genetic violent pathology of humankind can be fundamentally scientifically cognized/understood only in the context of its Gandhian cognitive historic evolution at the highest, holistic level of its “*substantially new manner of thinking*” (**Einstein**) **by the Gandhian spherons**.

This definition of the “**Manifesto**” final formula is illustrated in some key respects by the pragmatic appendices below. As the poet, Sergei Yesenin wrote: “**Face to face - you can't see the features. You need distance to see what is great [Gandhian spherons].**”

#### Appendix 1.

Professor **Evgeny Chazov**, Academician, IPPNW Co-President,  
from the 1985 Nobel Lecture

#### “**Tragedy and Triumph of Reason**”:

<https://www.nobelprize.org/prizes/peace/1985/physicians/lecture/>  
Synopsis

**Cicero: “Each man can err, but only fools persist in their errors”**. ... A lot of people are still under a delusion, consciously or involuntarily, as regards the significance of the arms race and its proliferation to outer space. However, *as Cicero put it*, “*Each man can err, but only fools persist in their errors*” [regarding nuclear weapons] ...

(After Hiroshima and Nagasaki), Prompted by the sense of responsibility for the fortunes of the human race, Einstein addressed the following warning to his colleagues: “*Since we, scientists, face the tragic lot of further increasing the murderous effectiveness of the means of destruction, it is our most solemn and noble duty to prevent the use of these weapons for the cruel ends they were designed to achieve*”.

Unfortunately, this appeal, like the warnings voiced by many leading scientists, has not reached the public conscience or the conscience of political and state figures. Nuclear arsenals on our planet have been increasing with every year, with every day...

Put forward by some state and military figures, the theory of preserving peace through “deterrence” led to the situation where nuclear might **transcended the limits of human perception**. Indeed, no one in this audience can really imagine one million Hiroshimas...

Over a million and a quarter physicians have signed the Amsterdam congress appeal against the nuclear arms race. We suggested the inclusion in the Hippocratic Oath a commitment to fight against the danger of a nuclear war (such an amendment has already been officially made to the Soviet physicians’ oath) ...

IPPNW is aware of the fact that wars start not from bombs dropped or shots fired – they start in the minds of people and are the result of political decisions. That is why our congresses regularly address world leaders, particularly of the USSR and the USA, calling upon them to do the utmost **to exclude the very possibility of a nuclear war and to reverse the nuclear arms race...**

**Our intellect cannot be reconciled with the situation when the world is heading toward nuclear death.** We physicians are neither politicians, nor military

experts. However, we have analyzed the present uneasy situation thoroughly enough to suggest to governments **our medical prescription for the survival of human-kind**. Our program has been elaborated, discussed and approved by IPPNW Congresses. It envisages a ban on tests of nuclear weapons and, as the initial step, a moratorium on nuclear explosions; a nuclear weapons freeze and the subsequent reduction and eventual liquidation of nuclear weapons; the non-proliferation of the arms race to outer space, no first use of nuclear weapons **and the creation of an atmosphere of trust and cooperation**.

It is not a political declaration **of either communists or capitalists** – it is what is demanded by reason, by people the world over who want to live.

Any reasonable man finds it hard to believe that while hunger, diseases, social inequality, economic underdevelopment and illiteracy are in existence, hundreds of billions of dollars are wasted to feed the insatiable monster – the arms race...

**What we need is cooperation, not confrontation** ... (What is not today, what is destroyed – L.S.) ...

The Nobel Prize awarded to our movement is not only a recognition of physicians' services in denouncing the nuclear illusions and promoting a true perception of nuclear weapons and effects of their use, but also **a symbol of international trust and belief in the infinite value and uniqueness of the human mind...**

Nuclear war, unless it is prevented, would lead to the extinction of life on Earth and possibly in the Universe. **Can we take such a risk?...**

Today we face a **seriously ill humanity, torn apart by distrust and fear of nuclear war**. To save it we must arouse the conscience of the world's peoples, **cultivate hatred for nuclear weapons**, repudiate egoism and chauvinism, and create favorable atmosphere of trust. In the nuclear age, we are all interdependent. **The Earth is our only common home, which we cannot abandon. The new suicidal situation calls for the new thinking. We must convince those who take political decisions.**

## **Leo Semashko Comment.**

Everything that is said in this lecture is the absolute truth today, in 35 years! Now, in 35 years, will there be scientists, academicians and politicians in Russia (especially) who can support, raise to a new scientific level of thinking and continue the saving humanistic absolute truth of academician Yevgeny Chazov?

Similar great ideas by Professor Bernard Lown, the US Co-President of IPPNW are presented in the theses of Professor Ernesto Kahan, former Vice President of IPPNW in the Manifesto above.

All absolute truths and great humanistic ideas of Academician Yevgeny Chazov find continuation and development at the level of new, spheral (by spheres/spherons) thinking of the **"Anti-Nuclear Peace/Cyberspheronics Manifesto"**, which compressed the GHA fundamental scientific discoveries and peacemaking achievements for more than 15 years of work of its international humanitarian team from nearly 60 countries.

This Manifesto offers a fundamental scientific model of **"Global Security/Peace"** that *"to exclude the very possibility of a nuclear [and any] war and...arms race"* and provides a societal, scientific, non-violent cure for *"seriously ill humanity."* This Manifesto expresses that *"Our intellect cannot be reconciled with the situation when the world is heading toward nuclear death."* It reveals the key global reasons for the preservation and buildup of genocidal nuclear weapons for 75 years:

- Pathological politics of global confrontation,



- The military-industrial complex, which designs, improves and manufactures nuclear weapons,
- Traditional democracy, with priority and generous funding for it with military budgets.

Our Manifesto shows non-violent, intelligent ways to overcome these causes for the benefit of all peoples in our century. We call on all scientists, politicians, public and religious figures of goodwill and reason to support this Peace Manifesto as **a reasonable recipe for survival in our century**, and to make self the possible intellectual and/or organizational contribution to it. **Maybe it, finally, will convince those who take political decisions.**

The Nobel lectures by Evgeny Chazov and Bernard Lown are an extremely important, especially for Russia, but not only, addition to the argumentation and justification of our **"Anti-Nuclear Peace/Cybersferonics Manifesto"**.

Appendix 2.

**Remember Hiroshima and Nagasaki!**  
**Ban all Nuclear Weapons Beginning with the United States!**  
**26-07-20**



Hiroshima after the US atomic bombing

On August 6, 1945 and again on August 9, 1945 the United States dropped atomic bombs on the cities of Hiroshima and Nagasaki, Japan. The stated reason for this first and still only use of atomic weapons was the need to hasten the end of World War II.

But Japan was devastated by months of the bombing of its cities, and numerous defeats at the hands of the United States military. Japan finally surrendered unconditionally when the Soviet Union declared war on the empire of Japan and briefly invaded Japanese held Manchuria. **The instant incineration of 250,000 people** and the additional tens of thousands more who died subsequently from associated wounds, radiation poisoning and radiation-induced cancers was primarily a warning to the Soviet Union whose war time marriage of convenience with the United States was about to end. [read more] <http://nepajac.org/nonukes.htm>

Now seventy-five years later the threat of nuclear war is again upon the world and the United States is still the perpetrator. The Trump administration has with-

drawn from nuclear treaties ratified with the Soviet Union and the Russian Federation decades ago. The Open Skies Treaty and the Intermediate Range Nuclear Forces Treaty have in effect been torn up by the Trump administration's unilateral withdrawals. The New Strategic Arms Reduction Treaty is next on the chopping block.

Seventy-five years later it is imperative to continue the work of nuclear non-proliferation. **The Bulletin of the Atomic Scientists has set the Doomsday Clock at just 100 seconds before midnight. Yet the issue of nuclear annihilation is rarely mentioned by the corporate media and has disappeared from the electoral agenda.**

Not only must Hiroshima and Nagasaki be commemorated but the issue of nuclear weapons must be front and center in all anti-imperialist work. The struggle must include a determination to speak against nuclear weapons being used as a pretext to confront nations targeted by the U.S. and NATO. Nations such as the DPRK, North Korea, should be approached as a sovereign states with their own interests. A final end of the Korean War, never officially ended nearly 70 years after the cessation of hostilities, would help to bring about meaningful negotiations. While the U.S. demonizes the DPRK, its ally Israel has an unknown number of nuclear warheads but is never mentioned as a country, which must end its nuclear capabilities. **The nuclear danger will only end when the U.S. and NATO end their threats against the rest of the world. The nuclear threat will end when all imperial aggressions end as well.**

Remember Hiroshima!  
Remember Nagasaki!  
Ban all nuclear weapons beginning with the United States!  
<http://nepajac.org/nonukes.htm>

Appendix 3.

**I Know How To Build A Society Without War.**

Interview of Leo Semashko for the World Growth Forums Magazine, October 2020.

Published: <https://www.worldgrowthforums.com/>  
[https://peacefromharmony.org/?cat=en\\_c&key=964](https://peacefromharmony.org/?cat=en_c&key=964)

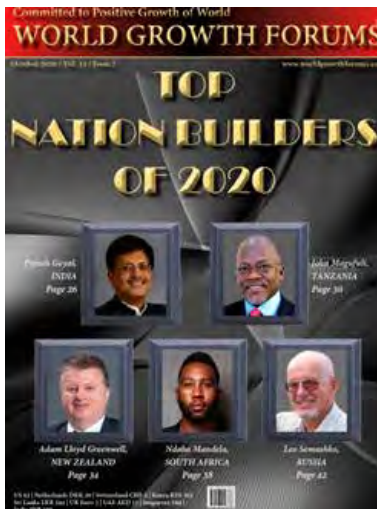

Intro: WGF brings to its readers an exclusive interview with Leo Semashko, who is a philosopher, sociologist, cyberneticist and peacemaker. He has devoted his entire conscious life to humanistic Gandhian values of peace, nonviolence, love, harmony, equality, justice and brotherhood of nations.

Quote: The GHA is an international peacemaking organization, created in 2005 and now uniting more than 600 humanitarians from 65 countries and about a million in the GHA collective members. For 15 years of its peacemaking activity, 10 books and 78 peacemaking projects have been created in the GHA with an innovative science called Cybersferonics, which develops the cybernetic cognition of global peace on the basis of Gandhian societal genetic spherons.

**WGF: Please tell us about yourself.**

L Semashko: Briefly, I identify myself with my life achievements as follows: philosopher, sociologist, cyberneticist and peacemaker from the harmony of the Gandhian spherons, providing global peace and prosperity to all nations and humanity as a whole. This is substantiated by my fundamental scientific research of about 50 years (more than 600 publications including 20 books) and my more than 15 years in the GHA during which 10 books were collectively written and 78 peacemaking projects were created under my scientific supervision. Therefore, I personify the GHA fruits, outside of the spiritual, friendly and harmonious aura of which they could not be created. I am sincerely grateful to the GHA, all its members and friends, for this fertile soil and atmosphere in which its fundamental/unprecedented scientific and peacemaking achievements were born.

**WGF: You are the Founder and President of the Global Harmony Association (GHA). Please share with us what is the GHA all about.**

L Semashko: The GHA is an international peacemaking organization, created in 2005 and now uniting more than 600 humanitarians from 65 countries and about a million in the GHA collective members. For 15 years of its peacemaking activity, 10 books and 78 peacemaking projects have been created in the GHA with an innovative science called Cybersferonics, which develops the cybernetic science of global peace on the basis of Gandhian societal genetic spherons. It was verified by world statistics in the 9th book of the GHA *Gandhica*, 2019: ([https://peacefromharmony.org/?cat=en\\_c&key=848](https://peacefromharmony.org/?cat=en_c&key=848)). The full list of GHA books and projects can be seen here: [https://peacefromharmony.org/?cat=en\\_c&key=472](https://peacefromharmony.org/?cat=en_c&key=472). The GHA Mission is "To bring peace from harmony and to pave a conscious way for harmonious Gandhian civilization of nonviolence on scientifically based 'The ABC of Harmony', 2012; 'Global Peace Science', 2016; and 'Gandhica', 2019 through harmonious education in them."

**WGF: SPHERONS are the eternal actors, the heart, the engine and the genome of the society and its global peace. In an unnecessary conflict of SPHERONS and PARTONS (whole and parts of society), is social harmony and global peace certain naturally with the passage of time?**

L Semashko: Yes, social harmony and global peace in society/humanity is its natural norm and the eternal genetic law of its survival, growth and development. There is no other law of its life. But its substance is so complex and deeply hidden that humanity has not yet matured to their clear scientific knowledge and understanding, remaining in the infancy of knowing this substance. However, the harmonious/peaceful nature of humankind was intuitively and partially revealed in the brilliant guesses of the world's greatest thinkers, from ancient times to the present day, which has been investigated in many of my scientific works, starting from 1975. Until a clear scientific understanding of this genetic nature, humanity remained and remains until now in its nescience/ignorance, which plunged it for many thousands of years into the infant era of wars, enmity, violence of the peoples

and different groups, deprived of knowledge of the structure/organization of their peaceful/harmonious/nonviolent life.

For the first time, Mahatma Gandhi began to speak about the science of peace and non-violence almost 100 years ago on the basis of his fundamental idea of equal varnas/spherons, suggested to him by their thousand-year prehistoric in ancient, pre-Vedic India. Only now, after the collapse of Marxism, which affirmed global revolutionary violence and after the deepest crisis of the imperialist violent system, science has become more attentive to the great, still undisclosed scientific heritage of the Gandhi's spherons nonviolence. His intuitive ideas of nonviolence were raised to the level of fundamental cybernetic science and a "substantial new manner of thinking" (Einstein) by the spheres/spherons of humanity that make up its eternal genetic code of survival, life and growth in the GHA books, especially in the mentioned "Gandhica", where they received justification and verification by world statistics.

Within the framework of the Gandhian paradigm of nonviolence spheres/spherons deployed here, a socio-genetic formula for survival, prosperity and World Growth of the Noosphere (WGN) was created based on four spheron societal clusters.

Briefly, it is written as follows:  $WGN = 4PIOT \times 4Spherons/SIOT \times 4Markets/SIOT \times 4Spheres/SIOT$ .

Its foundation is made up of 4 equally necessary and together sufficient societal/spheron resources of society/humanity/noosphere: People (all population), Information (any knowledge), Organization (any governance/order), Things (any material goods and services), in abbreviated form: PIOT.

PIOT define 4 equally necessary and together sufficient SPHERONS, societal/spheron classes of the population, differing by the production of PIOT: Socio-spheron, engaged in the production of people; Infospheron, engaged in the production of information; Orgspheron, engaged in the production of organizations; Technospheron, engaged in the production of things. Abbreviated: SIOT/Spherons. Spherons are made up of historical transient partial population groups called partons.

PIOT define 4 equally necessary and together sufficient societal/spheron Markets/exchanges (distribution/exchange processes) of these resources: Social (labor market), Informational, Organizational, Technical (market of material goods and services) markets. Abbreviated: SIOT/Markets.

PIOT determine 4 equally necessary and together sufficient societal Spheres of social production (social autopoiesis): Sociosphere (production of people, humans in a family, education, health care, etc. institutions), Infosphere (production of any knowledge), Orgsphere (production of any organizations), Technosphere (production of any material goods and services). Abbreviated: SIOT/Spheres. They include all other spheron clusters, defining and creating the integrity/holism of the noosphere/humanity.

All of the listed 16 spheron clusters of the noosphere/humanity genetic code ensuring its life at all levels from the individual and family to the global society, are equally necessary, because the absence/zero of any of them means its death, the impossibility of any social existence. The spontaneous, early state of the noosphere/humanity, still devoid of knowledge, consciousness and thinking of its societal genetic code in the spheres/spherons substance creates its constant violent, pathological deformations by militaristic confrontation and wars of various partons, professional and national parts of spherons. Wars, violence, militarism and confrontation of partons can be supplanted only by their peace and nonviolence within the framework of the conscious social harmony of spherons on the basis of

their fundamental scientific/cybernetic knowledge of their life spheral genetics, briefly expressed by the WGN formula.

All of the listed 16 spheral clusters of the noosphere/humanity genetic code are identical, constitute a common denominator at all its levels, but are always different in their internal, continuously changing numbers and in the infinite variety of their types and forms.

The “x” signs between the spheral clusters of the WGN formula express their necessary synergy, mutual multiplication, continuous growth and development in their harmonious unity, which excludes violence, confrontation and war.

In the paradigm of the spheral WGN, there are universal innovative tools for mastering their unprecedented complexity and integrity/holism through the corresponding global digitalization in spheral mathematical and fractal statistics and its numerous information technologies presented in “Gandhica” and in my other and GHA books.

The spheral Gandhian paradigm and its WGN formula is a social philosophy, a new vision and scientific instruments of an innovative global business that ensures harmonious spheral world growth, which stimulates the corresponding nation building and vice versa in a cybernetic feedback.

The traditional social science of the last century, mired in age-old ideological stagnation, was able to take only the term “nonviolence” (peace, harmony, love) from Gandhi’s brilliant teaching, but was powerless to understand its spheral sociogenetic nature, code and substance in its societal spheres/spherons, disclosed only at the beginning of the 21st century, in my and GHA books.

**WGF: What was your source for similar fundamental discovery in social science?**

L Semashko: The true author of this fundamental discovery is Mahatma Gandhi. The socio-cybernetic science presented above is only a modern disclosure, substantiation and verification by world statistics of the fundamental sociogenetic Gandhian law of the nonviolence varnas/spherons, in which the term “spherons” is only a modern universal synonym for ancient Indian “varnas”. The Gandhian Varnas Law is the law of spherons and vice versa. Gandhi defines this law in the following quotes, each of which is confirmed by our researches, and constitutes an unrecognized absolute truth of modern social science.

*“Varna is not a human invention, but an immutable law of nature – the statement of [genetic] tendency that is ever present and at work like Newton’s law of gravitation. Just as the law of gravitation existed even before it was discovered, so did the law of varna. Varna is the law of life universally governing the human family... this is the law of our being. All varnas are equal, for the community depends no less on one than on another. Though the law of varna is a special discovery of some Hindu seer, it has universal application. The world may ignore it today, but it will have to accept it in the time to come... “Varna is the best guarantee of a happy life...” [Gandhi, M. My Religion, 1955, pp. 169–172 – <http://gandhisevagramashram.org/pdf-books/myreligion.pdf>].*

Only the knowledge of this sociogenetic law, unknown to humanity, allowed Gandhi to achieve an impossible result for a violent civilization: to provide India with freedom and independence from the strongest violent British world empire without a single shot and without a single victim. Gandhi’s law, as the law of nonviolence, for so long has not been recognized by the traditional social science, built on violence; and therefore ideologically alienated from it, opens up for humanity a fundamentally new, holistic logic of a “substantially new manner of thinking” [Einstein], which ensures its survival in nonviolence, love, peace and harmony.

**WGF: Since 1970, after finishing the Moscow State University graduate school, your community participation has been immense. What drives you to keep on working towards a better society and a better planet?**

L Semashko: On this score, I have two fundamental motives. First, this is my mother's will to find a society "in which there is no war" so that people do not repeat her and my fate, when her husband and my father was killed in the first days of the war with the Nazis in June 1941, as written in many of my works.

The second one is the belief in the harmonious, humanistic nature of humankind, revealed by the entire history of world philosophy and crowned with brilliant scientific guesses of Mahatma Gandhi's nonviolence, who saw in its spherical substance "the greatest force of mankind mightier than the mightiest [nuclear] weapons of destruction." My thinking and work in this direction have made the meaning of my whole life, which I am very proud of.

**WGF: You have authored more than 600 scientific works on philosophy, sociology, culture, law and policy, including 20 books in many languages. What is the general focus in your writing?**

L Semashko: My orientation is conviction, faith and scientific fundamental justification of global peace/nonviolence from the social genetic harmony of the Gandhian spheres/spherons, briefly defined above.

**WGF: International bodies, such as the United Nations, are doing a lot for world peace. What more is possible and how?**

L Semashko: On the basis of the spherical Gandhian paradigm presented above, we have created several innovative fundamental peacemaking projects, including the project of a harmonious spherical UN. It is replacing the modern, disharmonious in its essence, and therefore the militaristic UN, which for 75 years, with all the partial peacemaking achievements, turned out to be structural and intellectually incapable of building a global security/peace system, which excludes continuous wars, an escalating arms race and a sharpening threat of global nuclear genocide/ecocide. Fundamental scientific perspective to improve the structure and technologies of global nonviolent governance are disclosed within the framework of the Gandhian paradigm in the last book of the GHA under my scientific guidance: "Anti-Nuclear Manifesto XXI" ([https://peacefromharmony.org/?cat=en\\_c&key=908](https://peacefromharmony.org/?cat=en_c&key=908)). In this "Manifesto" paradigm, its 44 co-authors from 25 countries, including four Nobel laureates are proposing to the UN and key nuclear powers to replace the genocidal nuclear triad with the Gandhian peace/spherons tetrad through the positive, constructive negotiations of these powers under the UN auspices. Why not then are they preparing a new START Treaty? Our opinion does not hinder but facilitates it and its perspective.

**WGF: How important is understanding and participation of youth in the anti-nuclear campaign?**

L Semashko: Young people are a decisive force in building a nuclear-free future in which to live. Young people and women who give birth and raise children not to become victims of the new global Hiroshima and who together make up almost 70% of the population are the main opponents of nuclear genocidal and terrorist weapons. Therefore, its elimination is inevitable. It will significantly accelerate if they arm themselves with fundamental scientific knowledge of the spherical Gandhian nonviolent paradigm presented in my and the GHA books.

**WGF: COVID-19 has been difficult all around the world. What learnings do you take away from this tough time?**

L Semashko: Lesson is one. Humanity – due to the global policy of pathological confrontation between leading powers and world leaders – lacks solidarity, cohesion, partnership and resources spent on lethal weapons, primarily nuclear, for joint and coordinated overcoming of the COVID-19 pandemic. It requires, above

all, a ban on nuclear weapons and the channeling of the freed up trillions of dollars to protect the world population from it.

**WGF: What are your future plans? What are the causes dear to your heart?**

L Semashko: My plans for the future are to complete the GHA latest book, dedicated to the new, Gandhian nonviolent democracy, as an alternative to traditional, militaristic/violent. It has finally discredited itself in the USA, the EU and other countries in its inability to solve the global problems of nuclear disarmament, pandemics, economic crises, environmental disasters, poverty, inequality and the like. The collapse and inevitable replacement of Western violent democracy was clearly predicted by Mahatma Gandhi. His prediction is coming true in our time. The dear humanistic Gandhian values of peace, nonviolence, love, harmony, equality, justice, brotherhood of nations are close to my heart, to the promotion of which I was happy to devote my entire conscious life.

**WGF: What message would you like to give to the people and youth of the world?**

L Semashko: My message to people and youth of the world is to understand, think, master the humanistic legacy of the Gandhian values, through education from early childhood in the books created over 15 years in the GHA under my scientific guidance and others like them, which we constantly propagandize and cite – these are primarily works on Gandhi’s nonviolence. Only such education of youth will become, in the words of its great successor, Nelson Mandela, “the most powerful weapon that will radically change the world”, transforming its violent, previous era into the Era of Nonviolence, Peace, Harmony and Love in the 21st century. I have this best message and wishes for young people, for my children and grandchildren.



Appendix 4.

## The GHA two Messages “I KNOW HOW” to the UN online book. Leo Semashko

1. “UN 75 Messages”. For the UN. The International peacemaking organizations ICAN and GHA attach “Anti-Nuclear Manifesto XXI” by 44 co-authors, including four Nobel laureates, from 25 countries ([https://peacefromharmony.org/?cat=en\\_c&key=908](https://peacefromharmony.org/?cat=en_c&key=908)). It equips humanity with compressed knowledge of HOW to build a society without war and violence. It fundamentally strengthens the UN’s thinking with the peacebuilding paradigm of the Gandhian’s nonviolent spherons tetrad replacing and supplanting the militaristic genocidal nuclear triad, leaving it no place and social basis for its existence in the 21st century. With this Gandhian paradigm in a modern scientific form verified by world statistics, the UN can firmly and reasonably declare that now, 75 years later, it knows well how to build

a world order of humanity without war and violence. The Gandhian paradigm of a nonviolent world order in our century, which ensures global security, peace and prosperity for all nations, leaves no room for nationalism and turns multilateralism into a modern Gandhian fourdimensional pluralism of irrefutable socio-cybernetic holistic science. Published:

<https://www.theonlinebookcompany.com/OnlineBooks/ThankyouUnitedNations/Contributions/Messages/194?p=2>

**2. For the Women Movement and Organisations.** Yes, the great *“UNSCR 1325 marked the first time the Security Council addressed the disproportionate and unique impact of armed conflict on women and recognized their contribution to conflict resolution and prevention. Twenty years later, it remains a transformative instrument to put women at the core of global leadership and all efforts to prevent conflict and end the scourge of war.”*

Now, through 20 years, the new fundamental step in the women’s thinking needs to lift their partner role and mission in the global leadership. To implement this step of the international women organisations, we, the international peacemaking organizations ICAN and GHA, are happy to suggest our “Anti-Nuclear Manifesto XXI” by 44 co-authors, including four Nobel laureates, from 25 countries ([https://peacefromharmony.org/?cat=en\\_c&key=908](https://peacefromharmony.org/?cat=en_c&key=908)). It equips women with compressed knowledge of how to build a society without war and violence. It fundamentally strengthens the women’s thinking with the peacebuilding paradigm of the Gandhian’s nonviolent spherons tetrad replacing and supplanting the militaristic genocidal nuclear triad, leaving it no place and social basis for its existence in the 21st century.

With this Gandhian paradigm in a modern scientific form verified by world statistics, the women’s organizations can firmly and reasonably declare that now they know well how to build a world order of humanity without war and violence. How to achieve full social, political and economic equality of women through the equality of the Gandhian spherons ([https://peacefromharmony.org/?cat=en\\_c&key=848](https://peacefromharmony.org/?cat=en_c&key=848)) and how ensure full gender partnership/balance in the spirit of the great ideas of Riane Eisler ([https://peacefromharmony.org/?cat=en\\_c&key=932](https://peacefromharmony.org/?cat=en_c&key=932)) and Helena Roerich ([https://peacefromharmony.org/?cat=en\\_c&key=815](https://peacefromharmony.org/?cat=en_c&key=815)).

The Gandhian paradigm of a nonviolent world order with the full spherical equality of women in our century, which ensures global security, peace and prosperity for all nations, leaves no room for nationalism and turns multilateralism into a modern Gandhian fourdimensional pluralism of irrefutable socio-cybernetic holistic science.

Published on 19-10-20:

<https://www.theonlinebookcompany.com/OnlineBooks/ThankyouUnitedNations/Contributions/UNSCR1325/10?p=2>

## Appendix 5.

### **Nuclear weapons are illegal now! Beatrice Fihn**

Dear Leo --

The big moment is finally here: the UN Treaty on the Prohibition of Nuclear Weapons (TPNW) just reached the 50 ratifications needed for entry into force! Just now, Honduras ratified the treaty - only one day after Jamaica and Nauru submitted their ratifications - bringing about a historic milestone. In 90 days the TPNW will enter into force and become binding international law!



Celebrate the news with us: Let the entire world know **nuclear weapons are illegal now!**

This is not just our victory. We congratulate and thank each and every one of you who stood with us to help make this moment happen. This is an incredible moment for our movement and we are so unbelievably proud of what we've all achieved together. And we hope you will continue to support our work as we go into the next phase.

With the treaty now ready to enter into force, everything will change, **but our work is not done.** We are going to need to get even louder to make sure the treaty lives up to its full potential. Once the treaty has taken full legal effect, countries that have joined it will need to comply with all of its obligations. In countries that have not joined, it is up to us to make sure that companies, governments and people know that nuclear weapons are illegal and that they need to stand on the right side of history.

Once again, we want to thank you and celebrate this special moment with you. Today, we congratulate all the leaders that joined the treaty, party - at a distance - with all the amazing people who helped make this moment happen, and begin the countdown for entry into force.

Thank you for everything you do,

**Beatrice Fihn**

Executive Director

International Campaign to Abolish Nuclear Weapons (ICAN)

It's time to end nuclear weapons.

October 24, 2020

Published: [https://peacefromharmony.org/?cat=en\\_c&key=943](https://peacefromharmony.org/?cat=en_c&key=943)

## Appendix 6.

### **Nuclear weapons are illegal now! But our work is not done still!**

**Leo Semashko**

Dear Beatrice, dear ICAN members,

The GHA is glad to publish your great news on your personal page ([https://peacefromharmony.org/?cat=en\\_c&key=943](https://peacefromharmony.org/?cat=en_c&key=943)) and distribute it all over the world through all our networks and channels.

We, the GHA members, your supporters around the world, are happy to share your powerful diplomatic victory in the ratification of the **"UN Treaty on the Prohibition of Nuclear Weapons"** (TPNW) by 50 UN member states. They ensures the entry into force of this treaty after 90 days, when it expires **"START-3"** torn apart by the USA, which, according to M.L. King's definition, are *"the greatest purveyor of violence and endless wars in the world."* Together with your TPNW, nuclear weapons become illegal, criminal under binding international law. We are happy to congratulate you and all peacemakers in the world on this anti-militarist victory in the international law field.

But you are absolutely right and wise about "but our work is not done [and] we go into the next phase!" Yes, the legal ban **is not the end, but only the beginning** of the real eradication of nuclear weapons by their practical abandonment and destruction by the nine nuclear powers. This is a way out of its ban from the legal area of international law, in which any adopted treaties/laws are easily torn apart, denounced and disavowed, as the practice of geopolitics of recent decades shows, into the plane of real international relations and their policy. As evidenced in **"The Criminality of Nuclear Deterrence/Terrorism"** (2013) by the USA leading

expert professor of international law, **Dr. Francis Boyle**, the crime and illegality of nuclear weapons is confirmed by the already existing international law after the Nuremberg Tribunal in 1945, which for decades (75 years) has been trampled by the nuclear powers ([https://peacefromharmony.org/?cat=en\\_c&key=957](https://peacefromharmony.org/?cat=en_c&key=957)). Therefore, we can conclude with 99% certainty that the entry into force of the new TPNW will face the same sad fate of the unwanted baby of international law, doomed to decades of ignoring, ignorance and neglect.

In connection with this real fact, "**a new phase of our work**" is acquiring extremely high priority and key importance for the prohibition of nuclear weapons. Our joint **Anti-Nuclear Manifesto XXI** ([https://peacefromharmony.org/?cat=en\\_c&key=908](https://peacefromharmony.org/?cat=en_c&key=908)) is dedicated to this fundamental peacemaking work in the sad fate of TPNW, easily predicted in it. Our **Manifesto** proceeds from the assessment of the status quo that as long as there will be a violent system of the world militaristic hegemonic order, supported by the fat, constantly growing military budgets of all national democracies in the world, especially the world leader, there will be a foundation and the possibility of nuclear weapons. It will always be the last, mightiest and decisive, albeit genocidal, argument/instrument of security in the world militaristic system.

To overcome this insane, misanthropic, criminal, suicidal system and eradicate nuclear weapons with all wars and violence can only by the global non-violent security/peace system on the genetic societal foundation/level of the Gandhian spherons of peace, non-violence and harmony of the noosphere/humanity. They are disclosed in our **Manifesto**, and succinctly presented in the GHA interview on 4 pages ([https://peacefromharmony.org/?cat=en\\_c&key=964](https://peacefromharmony.org/?cat=en_c&key=964)). It answers a simple question that is inaccessible to the existing violent world order: "**HOW to build a society without war/violence?**" The militaristic system excludes this question and does not raise it, because **it does not know** the answer to it, is unable to answer it and **does not want to answer** it. Since **knowing the answer to it puts an end to this system** and opens a breakthrough from it into its opposite - in an era of global peace, security and nonviolence.

Therefore, no one in this system has an answer/knowledge to this question, **does not exist and cannot be**. This knowledge/answer is possible only from its spiritual, fundamental dissidents, such as Mahatma Gandhi, Martin Luther King, Nelson Mandela, GHA and their followers. This knowledge became possible and accessible only for the GHA as a result of its 15 years of search and work in this direction, **only within the framework of nonviolent thinking by the Gandhian spherons of peace**, which the GHA provided verification by world statistics in **Gandhica** ([https://peacefromharmony.org/?cat=en\\_c&key=848](https://peacefromharmony.org/?cat=en_c&key=848)). Only within this paradigm is a scientific societal answer/knowledge possible to the question posed.

Our **Manifesto** shows that knowledge of the answer to a simple question: "**HOW to build a society without war**" can be obtained only in accordance with two cognitive laws: 1. "**Who knows the unknown [spherons], the impossible is available to him**" and 2. No one problem "**Cannot be solved at the same level of thinking at which we created it**"; therefore, to solve them, "**A substantially new [non-violent, asymmetric] manner of thinking of humanity is required**" - it is Einstein's law.

Therefore, the GHA, as your loyal and reliable supporter, invites ICAN to master the proposed fundamental Gandhian knowledge/thinking of spherons, **only based on which and only in the context of which** it is possible the complete elimination of nuclear weapons in the 21st century. This is that long, "**new phase of our unfinished work**" that you deeply understand and wisely express. Our **Manifesto** serves to it as a long-term strategic program for decades.

Best wishes for peace without nuclear weapons from the Gandhian spherons harmony,

Dr. Leo Semashko,  
GHA Founder and Honorary President,  
26-10-20

### Appendix 7.

## **Gandhica: Holistic Mega-Thinking for the UN and Humanity. Leo Semashko et al.**

Dedicated: On the United Nations Day 24th October 2019.

To the UN national Ambassadors for your education and enlightenment in the Gandhian peacemaking mega-thinking by spheres/spherons as “a substantially new way of thinking if humanity wants to survive” (Einstein)



**We, humanity, require from the UN a “substantially new” mega-thinking by the Gandhian spherons to guarantee survival and global peace via 75 years after the Victory over fascism on May 9, 1945 in the bloodiest WWII with 138 million victims of 62 countries.**

The next year marks the 75th anniversary of the UN birth along with the Victory over fascism and the militaristic atomic bombings of Hiroshima and Nagasaki with about 300,000 civilian casualties 75 years ago, which, unfortunately, have not been condemned by the UN so far. The growing militaristic trend of history over the course of 75 years has brought humanity close to the nuclear catastrophe of the global ecocide/genocide with the participation of the UN, in the eyes of which all international brakes of this catastrophe **have been completely destroyed in recent decades.**

The UN owns during this time many private peacemaking initiatives and achievements. But in solving the fundamental problem of achieving global peace, the UN is as far away as it was 75 years ago. Moreover, **humanity, together with the UN, for 75 years has gone even further from peace than in 1945.**

With its former, but long outdated partial micro/meso-thinking, it is powerless before this global catastrophe at the door, does not see the light of survival at the end of this deadly tunnel and is not able to offer an adequate agenda. This requires understanding and scientific knowledge of the new reality and substance of humanity, discovered more than 40 years ago - **spherons or spherical classes of the population** employed in the spheres of social production/autopoiesis and therefore called spherons.

The global world in our century requires scientific knowledge of the new reality/substance of humanity, which was discovered by Gandhi almost 100 years ago - the knowledge of **spherons or spherical classes of the population employed in the spheres of social production/autopoiesis and called spherons.**

The statistical evidence of the spherons reality as an source of global peace/non-violence and the Gandhian "**substantially new**" holistic mega-thinking developed on their basis are presented in detail in the GHA ninth book briefly called "**Gandhica**": [https://peacefromharmony.org/?cat=en\\_c&key=904](https://peacefromharmony.org/?cat=en_c&key=904). Its main content and significance see in the abstract below.

1. **The humanity key existential requirement today.** A. Einstein formulated the law of survival 70 years ago: "*We shall require a fundamentally new manner of thinking if humanity is to survive,*" because "*the significant problems we face cannot be solved at the same level thinking we were at when we created it*" [1]. This requirement has been formulated dozens of times by other prominent thinkers. [2]

2. **The centuries-old stagnation of the traditional social/human sciences of economic materialism with its political violence.** This is the stagnation of the dominant partial and torn micro/meso-thinking under the baseless ideological motto: "**it is omnipotent, because it is true.**" The past century has proved its falsity and powerlessness in solving global problems. It stopped the progress of social cognition/sciences, depriving them ability to find and discover the "*substance of a new manner of thinking*" according to Einstein. It buried for 75 years with the stigma "utopia" the only example of the latter in the teaching/practice of Gandhi's non-violence [3]. During this time, it created a "super destructive" nuclear weapon of complete ecocide and genocide, but it was powerless to scientifically understand and explain "**non-violence as the greatest force of mankind, [which] is mightier than the mightiest weapon of destruction**" including today nuclear weapon on Gandhi. It is primarily necessary for the UN, which, however, ignored it for 75 years, not understanding it. But with the traditional partial and depressive micro/meso-thinking and its ideologies, humanity and the UN in the 21st century cannot live or survive, because they are not able to free themselves from the fundamental threat of nuclear self-destruction "**at the same level of thinking at which they created it**" (Einstein). Therefore, a "**substantially new manner of thinking**" is required for survival, which is hindered by the century-old stagnation of the social sciences and their partial micro-thinking.

3. **The definition of "a substantially new" Gandhian spherical tetranet thinking.** *This is a systemic, creative, cybernetic, nonviolent, asymmetric global mega-thinking by the mega-structures of the spheres and spherons of society in the statistical mega-laws framework of their genetic harmony with the planetary spherical mega-ecology.* Its holistic visual expression is the sociocybernetic GENOME of spherical mega-structures of society and planet on p. 27 of Gandhica.

4. **An alternative of survival.** Humanity faces an alternative of **either** its surviving with a new mega-thinking **or** self-destruction in a total nuclear war. To survive, humanity and the UN should nonviolent "hack" the dominance of micro-thinking and its world order [6; 7] by a "**substantially new**" tetranet mega-thinking by spherons. **There is no other way of survival and future without and beyond spherons for it.**

5. **The UN education/enlightenment in the "substantially new" mega-thinking of Gandhica as "the most powerful weapon to change this world" (Mandela) and to survive humanity.** For this, the UN needs to create, under its auspices, the Gandhian Peacemaking Mega-Thinking Innovation Scientific Center (GPMT ISC) of 12 to 15 GHA experts with annual funding of **\$200 thousand**. It can ensure the development of Gandhian Global Peace Science and its nonviolent peacemaking mega-thinking in the Gandhica's spheres/spherons. To begin with

and experiment, we propose creating this Center for 6 months with financing of only **\$ 100 thousand**.

Will the UN, or at least one member of it, find \$ 100,000 for the “*substantially new*” Gandhian peace mega-thinking in order to provide a breakthrough to global peace and not move away from it for another 75 years but to approach it? **It is the Shakespearean question:** to be or not to be global peace? Can the Gandhian “*substantially new*” peacemaking mega-thinking find at least one supporter in the UN?

GHA is happy to congratulate the UN birthday and wish it to master breakthrough peaceful thinking in order to survive and not repeat the sad fate of the League of Nations. It is the GHA Message for this. Happy birthday!

Full publication: [https://peacefromharmony.org/?cat=en\\_c&key=904](https://peacefromharmony.org/?cat=en_c&key=904) . 24-10-19

## Appendix 8.

### **To Prime Minister of Japan. To Sign and Ratify the Treaty on the Prohibition of Nuclear Weapons (TPNW). Japan Council against A and H Bombs**

Across the world, people are calling for advancing from the entry-into-force of the Treaty on the Prohibition of Nuclear Weapons (TPNW) to the elimination of nuclear weapons. Having listened to the voices of the Hibakusha, more and more countries are choosing to achieve the “*security of a world without nuclear weapons*”, not the “security by nuclear weapons”, and are supporting and joining the TPNW.

The government of Japan, the only country to have suffered the atomic bombing in wartime, must stand at the forefront of the efforts to achieve the elimination of nuclear weapons.

Over 70% of the Japanese people believe that Japan should join the TPNW, as shown in opinion polls. What is called for is for the Japanese government to sincerely respond to the voices of the Hibakusha and people of Japan.

I hereby urge the government of Japan to sign and ratify the Treaty on the Prohibition of Nuclear Weapons.

This signature campaign starts during the U.N. Disarmament Week of October 2020. Collected signatures will be submitted to the government of Japan. The campaign promotion office is at Japan Council against A and H Bombs (Gensuikyo).

#### **Japan Council against A and H Bombs (Gensuikyo)**

2-4-4 Yushima, Bunkyo-ku, Tokyo 113-8464 Japan, E-mail: [antiatom@topaz.plala.or.jp](mailto:antiatom@topaz.plala.or.jp), Tel: 81-3-5842-6034 Fax: 81-3-5842-6033,

Web Site: <http://www.antiatom.org>,

## Appendix 9.

### **Signature Campaign to Urge Japan to join TPNW Launched**

Dear friends. A signature campaign to urge the Japanese government to sign and ratify the Treaty on the Prohibition of Nuclear Weapons (TPNW) was launched in Japan on October 29, 2020. A starting ceremony of the campaign was held in Tokyo, Hiroshima and Nagasaki simultaneously on that day. **As of Oct. 29, 128 prominent people in various fields**, such as the Hibakusha, academy, religion, entertainment, politics and peace and citizen’s movements, became joint propos-

ers of the campaign. It aims to create a consensus among the people of Japan that the Japanese government should sign and ratify the TPNW.

The joint proposers include: Setsuko Thurlow, Hiroshima survivor, Terumi Tanaka, representative director of Japan Confederation of A- and H-Bomb Sufferers Organizations (Nihon Hidankyo), Ryuichi Sakamoto, musician, Makiko Tanaka, former minister of foreign affairs, Naoki Tanaka, former minister of defense. (see the attached list of joint initiators.)

We, the Japanese movement against A and H Bombs, are very happy to see the TPNW entering into force in January 2021. In view of emerging changes, shown in an open letter of 56 former leaders and ministers of US allies to call on current leaders to join the Treaty, we think that a next-stage struggle is **to end the myth of nuclear deterrence and change the policy of nuclear weapon states and nuclear umbrella states**. We have also received positive responses from NATO member states and others to the "Letter from Nagasaki" of the 2020 World Conference against A and H Bombs online.

Now in Japan, people's criticism toward the politics of the Suga government that took over the Abe politics is spouting out. According to an opinion poll, 72 % of the people believe that the government of Japan, the A-bombed country, should join the Treaty. Civil Alliance for Peace and Constitutionalism decided to put an item of urging the Japanese government to sign and ratify the Treaty into the common policy of opposition parties' united candidates for the coming general election. A momentum to change the government is growing.

Also, from the situation in Asia over peace and security, we think that this signature campaign is important. The US-China confrontation is going on all over the world. In Asia, their hegemonistic war-game over the East China Sea and South China Sea is intensifying, involving joint military exercises. To counter China, the US is strengthening military buildup and deployment in Asia-Pacific region, **and Japan is playing a bad role of helping the US, which threatens peace and security of Japan and its people**.

We call on you, peace activists in the world, in particular, in nuclear weapon states and nuclear umbrella states, to develop campaigns/actions to urge your governments to join the Treaty. If you have already planned or are doing such campaigns/actions, **please let us know. We welcome such information** as well as your support message to our campaign to encourage the Japanese movement. Thank you.

#### Appendix 10.

### **On the Occasion of the Fiftieth Country's Deposition of Instrument of Ratification (Accession) of the Treaty on the Prohibition of Nuclear Weapons. October 25,2020. Japan Confederation of A-and H-Bomb Sufferers Organizations. (Nihon Hidankyo)**

On October 24 of this 75th anniversary of the atomic bombing, the fiftieth deposition of the instrument of ratification (or accession) of the Treaty on the Prohibition of Nuclear Weapons has been completed, meeting the requirement for entry into force of the treaty.

It is a remarkable accomplishment achieved 3 years since the treaty was adopted by 122 countries at the U.N. on July 7, 2017. The TPNW is to enter into force early next year, when 90 days have elapsed after October 24. With this, nuclear weapons will be prohibited by the treaty both in name and in reality. A

sure path has been opened to achieving the Hibakusha's long-time aspiration of abolishing nuclear weapons. This day will be engraved in human history, together with the days on which the first nuclear weapons were detonated over our heads in August 1945.

Having long called for the prohibition and elimination of nuclear weapons, we the Hibakusha welcome this day with great joy, truly feeling that our survival has been rewarded. We would like to report this achievement **to the hundreds of thousands of victims who were killed 75 years ago** without knowing what had happened, as well as to our forerunners who have dedicated their lives to the cause of the Hibakusha movement. At the same time, we would like to share our joy with so many people and organizations, both in Japan and internationally, who have supported the Hibakusha and worked together with us over many years in the movement to abolish nuclear weapons and create a world free of nuclear weapons and war, and also with the governments and citizens of the countries who have committed to achieving the entry into force of the treaty.

However, **the five nuclear powers, recognized as the nuclear weapon states in the Nuclear Non-proliferation Treaty (NPT), their allies and 4 other nuclear-armed states continue to oppose the TPNW. To our great regret, Japan, the only country to have suffered from the use of nuclear weapons in wartime, remains among them.**

To date, the Japanese government has argued, *"Though nuclear weapons are contrary to the spirit of humanitarian laws, they are not illegal, as there is no positive law explicitly banning them"* and *"The International Court of Justice, while ruling that the threat ruse of nuclear weapons was illegal, did not make a definitive conclusion in an extreme circumstance, in which the very survival of a State would be at stake."* Based on these arguments, it has maintained that the use of nuclear weapons is not prohibited by international law, and continues to uphold a security policy relying on nuclear deterrence

**But now, such excuses no longer pass muster. The Japanese government and its Diet should play a leadership role in achieving a total ban on nuclear weapons. Once again, we request the Japanese Government to change its nuclear policy immediately, sign and ratify the TPNW without delay and work in the forefront for the achievement of a nuclear weapon-free world.**

We the Hibakusha have continued to work both in Japan and in other countries to bear witness to the fact **that atomic bombs are weapons of absolute evil, which cannot coexist with human beings.** Since 2016, we have promoted the International Hibakusha Appeal Signature Campaign, asking citizens of the world to support our appeal to all governments to conclude a treaty to ban and eliminate nuclear weapons.

Today, many citizens in nuclear-armed countries have come to **know that nuclear weapons are anti-human and unnecessary.** With the TPNW coming into force, it would be illegal in light of international law to invest vast amounts of money, time and human resources to produce and possess them. **But the danger of nuclear weapons being used is not yet eliminated. If that happens, the potential consequences would be immeasurable.**

The aspiration of the Hibakusha is to ensure that **"no more Hibakusha will be created"**. Not much time is left for aging Hibakusha. With all our might, we will continue to walk with all of you peace-loving people towards a world without nuclear weapons or war. Email: [kj3t-tnk@asahi-net.or.jp](mailto:kj3t-tnk@asahi-net.or.jp), <http://www.ne.jp/asahi/hidankyo/nihon/english/img/202010Statement-on-the-50th-ratification.pdf>

## IX. Pragmatic Resume for the UN Spherons Discussion/Polylogue

Gandhian “*Anti-Nuclear Manifesto*” of Global Security/Peace (GSP) by the 46, including four Nobel Peace Laureates, coauthors from 26 countries for its discussion and promotion through the UN.

How can the GSP system become attainable for the UN? - Only through the paradigm of “*a substantially new manner of thinking*” by the Gandhian spherons.

### **Dear representatives of 193 national UN Missions in New York and Vienna!**

We, the coauthors of the Gandhian “*Anti-Nuclear Manifesto*”, created jointly by the GHA and the ICAN within the Gandhian vision framework of nonviolence varnas/spherons and synergistically combining almost the entire range of opinions of world civil society, should ultimately answer the key pragmatic question: **for what and to whom**, in the first place, our **Manifesto is needed with its unique intellectual potential?** The pragmatic response theses as an explanatory note are below.

1. **The historical, obvious fact** of the last 75 years of human evolution is that humanity in 2020 is farther from Global Security/Peace (GSP) and closer, just 100 seconds (Mecklin, 2020) to a nuclear, suicidal third world war than in 1945 year.

2. **The GSP system**, which excludes the need and the possibility of nuclear weapons, as well as any violence, militarism and the arms race, is the embodiment of the UN first statutory goal as the supreme international body of modern humanity since 1945. To its great regret, the GSP system remained in 2020 just as unattainable, impossible and inaccessible to the UN at the same zero theoretical and practical level as 75 years ago. Why, in all this considerable time, did the UN not approached but retreat, with all its **remarkable partial achievements** in resolving local conflicts and extinguishing endlessly erupting regional wars, from its constitutive goal of the GSP? What is the reason for this negative UN trend, which is not offset by its positive trend of partial peaceful success over 75 years?

3. **Its cause** was realized and brilliantly expressed by Albert Einstein 70 years ago in his two cognitive laws, which have remained ignored by the UN until now. These laws are formulated in Section IV of the *Manifesto*. In short, they read:

**Einstein’s Law-1:** “*Traditional thinking is unable to solve the significant problems it has created.*” Therefore, nuclear and any disarmament, like the construction of the GSP system, is impossible in it.

**Einstein’s Law-2.** “*A substantially new manner of thinking is needed if humanity is to survive.*” Similar “*a substantially new manner of thinking*” necessary for humanity to survive is Gandhian thinking by spherons, which have been verified by world statistics in the GHA during 15 years, and their thinking is developed in the proposed “*Anti-Nuclear Manifesto*”, rightfully called “*Gandhian*” and nothing else.

4. **The scientific understanding** and conscious building the GSP system under the leadership of the UN is impossible in the paradigm of traditional thinking with its destructive attributes of partialness, fragmentation and discontinuity and with its rejection of the Einstein’s cognitive laws. It can become possible, accessible and acceptable to all peoples only in the paradigm of Gandhian thinking by the equal necessary societal varnas/spherons. They were discovered by Gandhi almost a century ago, but remained inaccessible to official/traditional social science in its partial, split, incompatible and hostile ideologies excluding peace, harmony and nonviolence and recognizing only “*eternal struggle/war/violence*”. This ideologized science, and after it the UN, ignored Gandhi’s alternative, holistic spherical



approach and his thinking by the holistic and equal spherons of nonviolence, peace, love, harmony and justice.

5. **Therefore, only similar thinking** can provide the UN with a way out of the zero intellectual impasse with the GSP system. Only on its axiological and target basis, reflecting the common societal genetics and the fundamental denominator of all countries and peoples, and only on the basis of equal spherons as their real full-fledged actors it is possible and accessible to consciously long-term strategic construction of the GSP system by united humanity under the UN leadership. All this is proved, explained and deployed in our "**Manifesto**", which develops and raises the corresponding brilliant nonviolent intuitions of Mahatma Gandhi and his great successors Martin Luther King and Nelson Mandela to the level of fundamental science requiring further systemic research. Therefore, its quintessence is defined as follows: "*The Gandhian tetrad of equal and peaceful spherons of nonviolence will replace the genocidal nuclear triad and ensure the construction of the GSP system.*"

6. **In this regard**, the UN has no other need today than to master a new, Gandhian, "*substantially new way of thinking*" by the spherons in the proposed "**Manifesto**" that constitutes its unique intellectual advantage. It will enable the UN to overcome its traditional thinking, which in 75 years turned out to be powerless even to approach the formulation of the key problem of humanity survival through building the GSP system. Who else if not the UN can show an example of this "*substantially new way of thinking*" by the Gandhian spherons in order to achieve the realization of its constituent statutory goal: GSP.

7. **Therefore, the Gandhian "Anti-Nuclear Manifesto"** is necessary, first, for the UN to put on its agenda the permanent, constitutive and long-term issue of building fundamental GSP system by the joint efforts of all peoples. Only in this case the UN will fulfill its historic mission before humanity and will not repeat the sad fate of the League of Nations, which was unable to prevent the WWII. Moreover, as Gandhi wrote: "*Unless we can have a new way of fighting imperialism of all brands in place of the outworn one of a violent rising, there is no hope for the oppressed races of the earth.*" "*The weapon of violence, even if it is the atom bomb, becomes useless when it is matched against true non-violence [of spherons].*"

8. **Mastering the Gandhian thinking** by spherons will allow the UN to arm itself with another cognitive law: "*who knows the unknown, the impossible is accessible to him.*" The GSP system building from an unattainable and impossible task for the traditional UN, turns in the Gandhian thinking by spherons into an attainable and possible one. This UN mindset transforms the GSP's impossible task into a possible and accessible one.

9. **The GSP system** becomes especially necessary in connection with the ratification on 23 October by the 50th UN member state of **the UN Treaty Prohibition of Nuclear Weapons** (TPNW), initiated by ICAN and approved in 2017 by the UN General Assembly, and its entry into force in January 2021 year. There is a huge historical distance from the legal, easily torn apart and rejectable ban on nuclear weapons as a first step to actual nuclear disarmament of real social and political transformations in the GSP system construction, not yet known to humanity. The historical significance of this treaty is that it launches a new trend of joint conscious, without any ideological and political confrontation, building the GSP system as a nonviolent multipolar harmonious world order, completely excluding nuclear weapons, and in the future, all national armed forces. The TPNW implementation puts this historic task first on the UN agenda for the coming decades. Our **Manifesto** is needed exactly for this primary goal of the UN.

**10. The UN first practical decision.** Our *Manifesto* is not limited to calling on all governments and world leaders to join the TPNW. He calls on them to start at the UN a long-term, systematic strategic work on the joint scientific formation of a new architecture of the GSP world order, excluding any need and possibility of nuclear weapons in it. Our "*Manifesto*" carries the first, cornerstone to the foundation of this architecture - the Gandhian spherons and thinking with this reality/substance.

Therefore, the "*Manifesto*" coauthors and supporters propose and invite the UN General Assembly to the first minimum step: to make a practical decision of the establishment on the official basis of one of the UN Institute, from the GHA/ICAN members, the GSP International Research Laboratory (IRL), for a start from 8 scientists and specialists. That within 6 months they could prepare "*The GSP Megascience, Architecture and Technology*" principled project for the UN discussion with its funding at least **\$100 thousand for this period.**

Similar decision can be taken on a proactive basis by the government of any country if the UN General Assembly will be unable to make it for any reason.

In any case, the launch of this research trend and movement in it has long become an urgent need for the UN agenda, which meets the humanistic ethics of humanity and its survival.

**11. The UN perspectives in solving and achieving 17 Sustainable Development Goals (SDGs), adopted by the UN in 2015 to 2030. The Gandhian spherons: "We know HOW to solve/achieve 17 SDGs in a single way".**

The Gandhian spherons scientific paradigm meets the formulated main UN requirements in the SDG implementation field:

1. To provide the new goals and tasks solution with an integrated and indivisible character, balance of all fundamental (spherical) components of sustainable development.

2. To encourage interdisciplinary and transdisciplinary scientific research in various sectors and fields that is fully consistent with the spherons theory.

3. Create a Set of Global Statistical Indices to monitor and track the achievement of 17 SDGs and their 169 targets. The theory of spherons includes the system of global spherical statistics, GlobStat, which is quite suitable for these purposes.

Thinking traditionally, as all, it is impossible to achieve the intended transformation of the world and fulfill the SDGs agenda. Therefore, there is a call for the UN: **Change your worldview and thinking with the unknown for yours paradigm of the Gandhian spherons in order to transform the traditional approaches of statistics, finance/investment, geopolitics and ecology that hinder the SDGs implementation.** Only knowing this unknown will you be able to achieve the impossible for the UN 75 years. This knowledge with an unknown worldview/thinking for the UN will be provided by the proposed "*The GSP Megascience, Architecture and Technology*" project.

Please start changing your vision/thinking with an elementary and short, in 2-4 hours, statistical research of the Gandhian spherons of your country, in order to **be convinced by your own experience**, together with their verification by world statistics in "*Gandhica*", in the truth of this global reality, unknown still. A simple methodology for this research is presented in the "*Manifesto*": V.20.

**The Resume preparation:**

Dr. Leo Semashko, the Gandhian "*Anti-Nuclear Manifesto*" Editor-in-Chief,

**Approved by:**

The Gandhian "*Anti-Nuclear Manifesto*" Coauthors,

December 4, 2020

All responses of the "*Manifesto*" 6-month discussion are published on its page here: [https://peacefromharmony.org/?cat=en\\_c&key=908](https://peacefromharmony.org/?cat=en_c&key=908)

## Bibliography

- Almond G.* (1990) *A Discipline Divided: Schools and Sects in Political Science*. 1990. SAGE Publications.
- Almond G., Verba S.* (1963) *The Civic Culture: Political Attitudes and Democracy in Five Nations*. Princeton University Press.
- Anonymous.* "Cybernetics is a false science." 2019 (In Russian) To whom? For what? [https://peacefromharmony.org/?cat=ru\\_c&key=842](https://peacefromharmony.org/?cat=ru_c&key=842)
- Ashby, W.* *An Introduction to Cybernetics*. – London: Chapman and Hall, 1956.
- Ashford R.* (1996) Louis Kelso's Binary Economy. *The Journal of Socio-Economics*, Vol. 25, No. 1, 1996.
- Avery J.* (2017) *Nuclear Weapons: An Absolute Evil*: [https://peacefromharmony.org/?cat=en\\_c&key=800](https://peacefromharmony.org/?cat=en_c&key=800)
- Avery J.* (2018) *A World Federation*: <http://eacpe.org/app/wp-content/uploads/2018/11/A-World-Federation-by-John-Scales-Avery.pdf>
- Avery J., Semashko L.* and others (2017) *Thermodynamics and Negentropy of Spherical Classes Societal Harmony*: [https://peacefromharmony.org/?cat=en\\_c&key=756](https://peacefromharmony.org/?cat=en_c&key=756)
- Azcona M. C.* (2005) *Peace, Literature and Art-UNESCO EOLSS Encyclopedia*: <https://www.eo-iss.net/ebooklib/bookinfo/peace-literature-art.aspx>
- Azcona M. C.* (2014) *About Peace and Peacemaking*. Cook Communications, USA: [https://www.amazon.es/s?i=stripbooks&rh=p\\_27%3AMaria+Cristina+Azcona+%28Ed+%29.&ref=dp\\_byline\\_sr\\_book\\_1](https://www.amazon.es/s?i=stripbooks&rh=p_27%3AMaria+Cristina+Azcona+%28Ed+%29.&ref=dp_byline_sr_book_1)
- Azcona M. C.* (2016) *Strategies for Peace*. Cook Communications, USA: <https://www.amazon.com/Strategies-Peace-Bruce-Cristina-Azcona/dp/1365188310>
- Baimuratov U.* (2015) *Manifesto of Harmonious Consciousness. Crises, Cataclysms and Conflicts: How to Overcome the Destructive Synergy of Three «C» (New redaction).*./Socrates Almanac, OXFORD. – p. 304–306.
- Bateson, G.* *Steps to an Ecology of Mind*, Paladin, New York, NY, 1972.
- Berndt, H., Scott B., Semashko L.* *Tetrasociology and sociocybernetics: towards a comparison of the key concepts*, 2003. – Pp. 222–232. – [https://peacefromharmony.org/docs/2-2\\_eng.pdf](https://peacefromharmony.org/docs/2-2_eng.pdf)
- Blechman B. M.* (1985) *Preventing Nuclear War: A Realistic Approach*.
- Boyle F.* (2013) *The Criminality of Nuclear Deterrence*. Clarity Press
- Brennan J.* *Against Democracy*, 2016. [press.princeton.edu](http://press.princeton.edu).
- Caldicott H.* (2020) *HIROSHIMA: The Lessons We Haven't Learned: 75 Years After The US Atomic Bombings of Japan, We Remain Perched on The Precipice of Unparalleled Catastrophe*: <https://portside.org/2020-08-07/hiroshima-lessons-we-havent-learned>
- Chappell P.* (2012) *PEACEFUL REVOLUTION: How We Can Create the Future Needed for Humanity's Survival*. Easton Studio Press: <https://paulkchappell.com/peaceful-revolution/>
- Covey Stephen R.* (2011). *The 3<sup>rd</sup> Alternative*. New York: Free Press
- Creque G.* (2020) *Le Messenger De La Paix*: [https://editions-du-cordeau.com/index.php?id\\_product=49&id\\_product\\_attribute=0&rewrite=le-messenger-de-la-paix&controller=product](https://editions-du-cordeau.com/index.php?id_product=49&id_product_attribute=0&rewrite=le-messenger-de-la-paix&controller=product)
- Dinucci, Manlio* (2020). *Nuclear Euromissiles Are Back*: <https://www.globalresearch.ca/nuclear-euromissiles-back/5729986>
- Dinucci M.* (2020) *The Nuclear Bomb Is Ready: In Italy Soon*: <https://www.globalresearch.ca/bomb-ready-italy-soon/5731119>
- Dinucci M.* (December 2020) *How to Get Saved from COVID-19 Under Nuclear Bombs*: <https://www.globalresearch.ca/how-get-saved-covid-19-under-nuclear-bombs/5731682>

*Durkheim E.* The Division of Labour in Society, 1996.

*Ecimovic T.* SPHERONS' Argumentation: Detailed Review, 2017. – [https://peacefromharmony.org/?cat=en\\_c&key=747](https://peacefromharmony.org/?cat=en_c&key=747)

*Ecimovic T., Avery J., Semashko L.* THE CLIMATE CHANGE SYSTEM 2017. Ed. 2017. – [https://peacefromharmony.org/docs/ECIMOVIC\\_CLIMATE%20CHANGE\\_18-04-17\\_Final.pdf](https://peacefromharmony.org/docs/ECIMOVIC_CLIMATE%20CHANGE_18-04-17_Final.pdf)

*Einstein A.* on Peace and Gandhi, in Richard B. Gregg, Profiles in Gandhi. – P. 100.

*Einstein A.* Quotes, 1955. – <https://www.brainyquote.com/quotes/quotes/a/alberteins104567.html>

*Eisler R.* (1994) The Chalice and The Blade. Harper Collins San Francisco: [https://peacefromharmony.org/?cat=en\\_c&key=932](https://peacefromharmony.org/?cat=en_c&key=932)

*Fedotova V. G.* "European Third Way" and Its Symbolic Significance for Russia and Other Countries. Sociological Review Volume 2. No 1. 2002 (In Russian): [https://sociologica.hse.ru/data/2011/03/30/1211856451/2\\_1\\_1.pdf](https://sociologica.hse.ru/data/2011/03/30/1211856451/2_1_1.pdf)

*Fihn B., Thurlow S.* (2017) International Campaign to Abolish Nuclear Weapons (ICAN). – Nobel Lecture: <https://www.nobelprize.org/prizes/peace/2017/ican/26041-international-campaign-to-abolish-nuclear-weapons-ican-nobel-lecture-2017/>

*Foerster H.* Understanding understanding. New York, NY: Springer Verlag, 2003.

*Foerster H., Broecker M.* Teil der Welt. Fraktale einer Ethik. Ein Drama in drei Akten, Heidelberg: Carl-Auer Verlag, 2002.

*Foerster H., Freund S.* Heinz von Foerster. Cyber-Ethics: A Portrait, 1992.

*Galtung J.* A Theory of Conflict: Overcoming Direct Violence. TRANSCEND University Press, 2010.

*Galtung J.* Cultural Violence. Journal of Peace Research, 1990. – Vol. 27, 3.

*Gandhi M.* (1946) My Life Is My Message. H, 1–6, p.172: [www.mkgandhi.org/momgandhi/chap94.htm](http://www.mkgandhi.org/momgandhi/chap94.htm)

*Gandhi M.* (1982) On Nuclear Arms: <https://www.mkgandhi.org/articles/NuclearArms.htm>

*Gandhi M.* (1998) *Mine & Metal Workers, Gandhi Jayanti 1998*: [https://www.mkgandhi.org/articles/constr\\_prog.htm](https://www.mkgandhi.org/articles/constr_prog.htm)

*Gandhi M.* (2014) My life is my message. Compiled by: Krishna Kripalani. Printed Navajivan, Ahmedabad: <https://www.mkgandhi.org/ebks/ownwords.pdf>

*Gandhi M.* My Religion, 1955: <http://gandhisevagramashram.org/pdf-books/my-religion.pdf>

*Giddens A.* The Third Way: the Renewal of Social Democracy. Cambridge: PolityPress, 1998.

*Greaney M., Kurland N.* (2016) Pope Francis and the Just Third Way: Global Peace from Harmony: [https://peacefromharmony.org/?cat=en\\_c&key=414](https://peacefromharmony.org/?cat=en_c&key=414)

*Gunther G.* (1972). Cognition and Volition: A Contribution to the Theory of Subjectivity. In *Collected Works of the Biological Computer Laboratory* (University of Illinois, Urbana, Illinois). Peoria, IL: Illinois Blueprint Corporation: [http://www.vordenker.de/ggphilosophy/c\\_and\\_v.pdf](http://www.vordenker.de/ggphilosophy/c_and_v.pdf)

*Guterres A.* (2018) Secretary-General's Press Conference at Nagasaki Peace Memorial Hall: <https://www.un.org/sg/en/content/sg/press-encounter/2018-08-09/secretary-generals-press-conference-nagasaki-peace-memorial>

*Guterres A.* (2020) 75<sup>th</sup> Anniversary of the atomic bombings of Hiroshima and Nagasaki: Time to end the nuclear menace: <https://www.un.org/sg/en/content/sg/articles/2020-08-06/75th-anniversary-of-the-atomic-bombings-of-hiroshima-and-nagasaki-time-end-the-nuclear-menace>

*Halper, Katie* (2019) The 11 Most Anti-Capitalist Quotes from Martin Luther King Jr: <https://www.commondreams.org/views/2019/01/21/11-most-anti-capitalist-quotes-martin-luther-king-jr>

- Heylighen F., Lenartowicz M.* (2020) Cybernetics. (Preprint, to be published in: Ritzer G. & Rojek C. (eds.) (2021) *Wiley Blackwell Encyclopedia of Sociology* (2<sup>nd</sup>. edition, Wiley-Blackwell Science publishers)
- Heylighen F., Joslyn C.* Cybernetics and Second-Order Cybernetics. In: R.A. Meyers (ed.), *Encyclopedia of Physical Science & Technology* (3<sup>rd</sup> ed.), Academic Press, New York, 2001: <http://pespmc1.vub.ac.be/Papers/Cybernetics-EPST.pdf>
- Kaznacheev Vail* (2014) The era of technocratism is over. What's next? // Noosphere. Society. Person.: <http://noocivil.esrae.ru/236-1256>
- Kelso L., Adler M.* (1958) *The Capitalist Manifesto*. Random House, New York;
- Kelso L., Kelso P.* (1968) *Equality of Economic Opportunity Through Capital Ownership*,... Doubleday & Co., New York;
- King, Dr. Martin Luther King, Jr.* (2010). "Where Do We Go from Here: Chaos or Community?", p.214, Beacon Press: <https://www.azquotes.com/quote/529003>
- King, Dr. Martin Luther King, Jr.* (2013). "A Time to Break Silence: The Essential Works of Martin Luther King, Jr., for Students", p.27, Beacon Press
- King, Jr., for Students*", p.27, Beacon Press
- King, Martin Luther King (Jr.)*, Alex Ayres (1993). "The Wisdom of Martin Luther King, Jr", Plume
- King, Martin Luther King, Jr.* *Beyond Vietnam -- A Time to Break Silence*, Delivered 4 April 1967, Riverside Church, New York City
- Kotila R.* (2016) World Federalists Seek Leadership from the European Union for a New UN: [https://peacefromharmony.org/?cat=en\\_c&key=680](https://peacefromharmony.org/?cat=en_c&key=680)
- Krasnov V.* (2019) Mahatma Gandhi and Aleksandr Solzhenitsyn, The Two Giants Who Blessed the 20<sup>th</sup> Century. Will Vladimir Putin, Other World Leaders Listen?: [https://peacefromharmony.org/?cat=en\\_c&key=884](https://peacefromharmony.org/?cat=en_c&key=884)
- Kurland N.* (1982) *The Capital Homestead Act*: [www.cesj.org](http://www.cesj.org)
- Kurland N., Brohawn D., Greaney M.* (2014) *The Just Third Way. How We Can Create Green Growth, Widespread Prosperity and Global Peace*: Center for Economic and Social Justice: [www.cesj.org](http://www.cesj.org)
- Kurland N., Michael D., Greaney M. and others* (2012) CESJ. OUR CORE VALUES. OUR CODE OF ETHICS: <http://www.cesj.org>
- Lee S. P.* (2018). Minimizing the Danger of Nuclear Weapons. In Cook, B. L. (Eds.), *Handbook of Research on Examining Global Peacemaking in the Digital Age* (pp. 45–50). IGI Global. <http://doi:10.4018/978-1-5225-3032-9.ch004>
- Lepskiy V. E.* Philosophical-Methodological Basis for the Formation of Third-Order Cybernetics. *Russian Journal of Philosophical Sciences*. 2018;(10):7–36. (In Russ.) <https://www.phissci.info/jour/article/view/2359/2612>
- Lepskiy V. E., Zadorozhnyuk I. E., Pirozhkova S. V.* (2018) Search Vector – Third-Order Cybernetics (Review of the International Interdisciplinary Scientific and Practical Symposium). *Voprosy Filosofii*. 2018. No. 6, pp. 208– 211 (in Russian): [http://vphil.ru/index.php?option=com\\_content&task=view&id=2002&Itemid=52](http://vphil.ru/index.php?option=com_content&task=view&id=2002&Itemid=52)
- Lown B., Chazov Y.* (1985) IPPNW Nobel Peace Prize Lecture: [https://www.nobelprize.org/nobel\\_prizes/peace/laureates/1985/physicians-facts.html](https://www.nobelprize.org/nobel_prizes/peace/laureates/1985/physicians-facts.html) ; <https://ru.citaty.net/tsitaty/1924964-bernard-lown-we-physicians-protest-the-outrage-of-holding-the-e/>
- Luhmann N.* *Introduction to Systems Theory*. –M.: Publishing House "Logos", 2007.
- Maguire M., Avery J., Semashko L.* (2018) US-Russia Summit. The Great Peace Charter XXI: <https://www.globalresearch.ca/us-russia-summit-a-manifesto-and-roadmap-of-global-peacebuilding-in-the-21st-century/5647028>

- Mandela Ndaba* (2018) *Going to the Mountain: Life Lessons from My Grandfather*, Nelson Mandela: <https://www.amazon.com/Going-Mountain-Lessons-Grandfather-Mandela/dp/0316486574>
- Mandela Nelson* (1993) Nobel Lecture.: <https://www.nobelprize.org/prizes/peace/1993/mandela/26130-nelson-mandela-nobel-lecture-1993/>
- Mandela Nelson, Bill Clinton, et al.* (2018) *In His Own Words*
- Mandelbrot B.* *The Fractal Geometry of Nature*. San Francisco: W.H. Freeman and Company, 1982.
- Martin G.* (2018). *Global Democracy and Human Self-Transcendence: The Power of the Future for Planetary Transformation*. Cambridge, UK: Cambridge Scholars Publishers.
- Maturana H.* *Neurophysiology of cognition*, in Garvin, P. (Ed.), *Cognition: A Multiple View*. – Spartan Books, New York, NY, 1970. Pp. 3–23.
- Maturana H., Varela F.* *Autopoiesis and Cognition*, D. Reidel, Dordrecht, 1980.
- Maturana H., Varela F.* *Autopoiesis: the organization of the living*, 1973// *Maturana H., Varela F. Autopoiesis and Cognition*.– Boston, 1980. – P. 63–134.
- McCulloch W.* *A heterarchy of values determined by the topology of nervous nets*, 1945. – Pp. 89–93.
- McCulloch W.* *Embodiments of Mind*. – Cambridge, Mass.: MIT Press, 1965.
- McMurtry J.* *U.S. Holds the World Record of Killings of Innocent Civilians*, 2013. – <http://www.globalresearch.ca/u-s-holds-the-world-record-of-killings-innocent-civilians/5393789>
- Mecklin J.* (2020) *Closer than ever: It is 100 seconds to midnight*. 2020 Domsday Clock Statement: [https://peacefromharmony.org/?cat=en\\_c&key=924](https://peacefromharmony.org/?cat=en_c&key=924)
- Moniz Ernest J.* (2020) *The risk of a nuclear attack is back at historic levels, 75 years after Hiroshima*: <https://www.nti.org/analysis/opinions/risk-nuclear-attack-back-historic-levels-75-years-after-hiroshima/>
- Mulej M.* (2016) *Social responsibility as a Precondition for Peace and Development Instead of the Current Global Socio-economic Crisis*: [https://peacefromharmony.org/?cat=en\\_c&key=473](https://peacefromharmony.org/?cat=en_c&key=473)
- Mulej M.* (2019) *Gandhian Democracy. Full Social and Peace Responsibility of Society: Innovation, Utopia and Systemic Behavior*: [https://peacefromharmony.org/?cat=en\\_c&key=473](https://peacefromharmony.org/?cat=en_c&key=473)
- Neumann J.* *Theory of Games and Economic Behavior*. – New Jersey: Princeton University Press, 2004.
- Назарбаев Н.* (2016) *Мир. XXI век. Манифест*. Астана: [https://peacefromharmony.org/?cat=ru\\_c&key=851](https://peacefromharmony.org/?cat=ru_c&key=851)
- Onoprienko V.* (2014) *Vernadsky-Kaznacheev Nekrosphere*: [https://peacefromharmony.org/?cat=ru\\_c&key=845](https://peacefromharmony.org/?cat=ru_c&key=845)
- Oxford Manifesto 1997. The Liberal Agenda for the 21<sup>st</sup> Century: The Liberal Manifesto, 1997*, Oxford, UK: [https://web.archive.org/web/20110207012341/http://www.liberal-international.org/editorial.asp?ia\\_id=537](https://web.archive.org/web/20110207012341/http://www.liberal-international.org/editorial.asp?ia_id=537)
- Paetau M.* *Niklas Luhmann and Cybernetics*. *Journal of Sociocybernetics*, 2013. – Vol 11, No ½. – <https://papiro.unizar.es/ojs/index.php/rc51-jos/article/view/790>
- Parsons T.* “The Present Status of ‘Structural-Functional’ Theory in Sociology”, *Social Systems and The Evolution of Action Theory*, New York: The Free Press, 1975.
- Parsons T.* *American Society: A Theory of Societal Community*. – Paradigm Publishers, 2007.
- Parsons T.* *The Present Status of ‘Structural-Functional’ Theory in Sociology*. *Social systems and the evolution of action theory*, New York: Free Press, 1977. – P. 100–117.
- Pask G.* *A cybernetic model for some types of learning and mentation*. In *Cybernetic Problems in Bionics*, Oestreicher, H.C. and Moore, D.R., (Eds.), Gordon and Breach, 1968. – Pp. 531–585.

- Pask G.* Conversation, Cognition and Learning. – Elsevier, Amsterdam and NY, 1975.
- Pathak Bishnu* (2020). Bombings in Hiroshima and Nagasaki. Victors' Justice or Victims' Justice through the Tokyo Tribunal: [https://peacefromharmony.org/?cat=en\\_c&key=910](https://peacefromharmony.org/?cat=en_c&key=910)
- Pawlik L.* (2020) Fungi Future – Biosphere Rescue Plan: [https://peacefromharmony.org/?cat=en\\_c&key=887](https://peacefromharmony.org/?cat=en_c&key=887)
- Pawlik L.* Hack or Die: How Humanity Steers Into Its Post-Digital Future. World Futures, 2019. – p. 58–68. –: [http://www.academia.edu/Documents/in/Heinz\\_von\\_Foerster](http://www.academia.edu/Documents/in/Heinz_von_Foerster)
- Piaget J.* Psychology and Epistemology. – Penguin, Harmondsworth, Middx, 1977.
- Pias C.* Cybernetics – Kybernetik (The Macy-Conferences 1946–1953). 2vols. Zurich & Berlin: Diaphanes, 2004.
- Poincare H.* The Foundation of Science. The Science Press. New York And Garrison, N.Y., 2013. – <https://archive.org/stream/foundationsscie>
- Poincare H.* The Foundations of Science, 1913. – <https://archive.org/stream/foundations-scie01poingoo#page/n224/mode/2up/search/201+page>
- Poincare H.* The Value of Science. New York: Dover, 1958.
- Ronfeld, D., Arquilla J.* (2020) Whose Story Wins: The Noösphere, Noöpolitik, And the Future of Statecraft: <https://www.researchgate.net/publication/339040249>
- Rush B.* (1984) A Plan of a Peace Office for the United States. Massachusetts Review
- Scott B.* (2019). In Defence of Pure Cybernetics. Cybernetics and H/K. Vol. 26 (2019), no. 4, pp. 99–110: [https://peacefromharmony.org/?cat=en\\_c&key=946](https://peacefromharmony.org/?cat=en_c&key=946)
- Scott B.* Cybernetic foundations for Psychology. Constructivist Foundations, 2016. – 11(3) – pp. 509–517.
- Scott B.* Education for cybernetic enlightenment. Cybernetics and Human Knowing, 2011. – 21(1-2) – PP. 199–205.
- Scott B.* Explorations in Second-Order Cybernetics: Reflections on Cybernetics, Psychology and Education. – Edition echoraum, Vienna, 2011.
- Scott B.* Human systems, communication and educational psychology, educ. Psychol. in Practice, 1987. – 3, 2 – pp. 4–15.
- Scott B.* Morality and the cybernetics of moral development. Int. Cybernetics Newsletter, 1983p. 520–530. Reprinted as chapter 5 in Scott, 2011.
- Scott B.* On Becoming a Cybernetician: Highlights and Milestones. World Futures, 2019. – 0: 1–12. – <https://www.tandfonline.com/eprint/bZGfNBIUvcCTsW2HSyv3/full?target=10.1080/02604027.2019.1591082>
- Scott B.* Second order cybernetics: an historical introduction, Kybernetes, 2004. – 33, 9/10 – pp. 1365–1378.
- Scott B.* Second-order cybernetics as cognitive methodology, Systems Research, 1996. – 13, 3 – pp. 393–406.
- Scott B.* Sociocybernetic Reflections on the Human Condition. ISA Forum Vienna, 2016 – [https://peacefromharmony.org/?cat=en\\_c&key=742](https://peacefromharmony.org/?cat=en_c&key=742)
- Scott B.* Sociocybernetic understandings of consciousness, 2017. – [https://peacefromharmony.org/?cat=en\\_c&key=742](https://peacefromharmony.org/?cat=en_c&key=742)
- Scott B.* Some thought about Leo Semashko's concept of 'spherons': ISA RC51 on Sociocybernetics. Newsletter 34, September 2017. – <https://sociocybernetics.files.wordpress.com/2017/09/rc51-newsletter-34.pdf>
- Scott B.* Tetrasociology. Editor's Introduction, 2002. – [https://peacefromharmony.org/?cat=en\\_c&key=147](https://peacefromharmony.org/?cat=en_c&key=147)

Scott B. The cybernetics of Gordon Pask, in Gordon Pask, *Philosopher Mechanic: An Introduction to the Cybernetician's Cybernetician*, R. Glanville and K.H. Müller (eds.). – Edition echoraum, WIS-DOM, Vienna, 2007. – Pp. 29–52.

Scott B. The role of Sociocybernetics in understanding world futures, *Kybernetes*, 2009. – 38, 6, pp. 867–882: – [https://peacefromharmony.org/?cat=en\\_c&key=741](https://peacefromharmony.org/?cat=en_c&key=741)

Scott B. Using the logic of life to reduce the complexity of life. *Cybernetics and Human Knowing*, 2012. –19, 3 – pp. 93–104.

Scott B. Working with Gordon: developing and applying Conversation Theory (1968–1978), *Systems Research*, 1993. – 10, 3 – pp. 167–182.

Semashko L. (2004) Manifesto of Spheral Democracy (Rus): [https://peacefromharmony.org/?cat=ru\\_c&key=392](https://peacefromharmony.org/?cat=ru_c&key=392)

Semashko L. (2010) “Spheral Democracy Group” in *Petrosoviet 1992*: [https://peacefromharmony.org/?cat=en\\_c&key=58](https://peacefromharmony.org/?cat=en_c&key=58)

Semashko L. (2010) “Spheral Democracy Group” in *St-Petersburg Parliament 1992*: [https://peacefromharmony.org/?cat=en\\_c&key=58](https://peacefromharmony.org/?cat=en_c&key=58)

Semashko L. (2017) *Philosophy and Dialectics of Spherons: From “Demiurge” (1976–1980) to the UN*: [https://peacefromharmony.org/?cat=ru\\_c&key=305](https://peacefromharmony.org/?cat=ru_c&key=305)

Semashko L. (Ed. 2020) GHA 77<sup>th</sup> Project. *The World Civil Society Security Council (WCSSC)*: [https://peacefromharmony.org/?cat=en\\_c&key=941](https://peacefromharmony.org/?cat=en_c&key=941)

Semashko L. and GHA coauthors. *Global Harmony International Treaty for Nuclear Disarmament*. 2009 – [https://peacefromharmony.org/?cat=en\\_c&key=384](https://peacefromharmony.org/?cat=en_c&key=384)

Semashko L. and GHA coauthors. *Russia-USA: Nuclear Zero*. 2016 – [http://peacefromharmony.org/?cat=en\\_c&key=710](http://peacefromharmony.org/?cat=en_c&key=710)

Semashko L. (2020) *I Know How to Build a Society without War*: [https://peacefromharmony.org/?cat=en\\_c&key=964](https://peacefromharmony.org/?cat=en_c&key=964)

Semashko L., Baimuratov U., et al. (2017) *Manifesto of the Noosphere Spherons (In Russian)*: [https://peacefromharmony.org/?cat=ru\\_c&key=711](https://peacefromharmony.org/?cat=ru_c&key=711)

Semashko L., Chandra S., Dhal P., Pawlik L, editors and 78 GHA coauthors from 25 countries. *Mahatma Gandhi. Nonviolence Starting Point. Spherons' Genome and Statistics. GANDHICA*. - New Delhi. Published by R.B.H. Media Designers, 2019. - 240 p.: [https://peacefromharmony.org/?cat=en\\_c&key=848](https://peacefromharmony.org/?cat=en_c&key=848)

Semashko L., DeWitt M. (2004) *Children's Suffrage: Democracy for the 21<sup>st</sup> Century*: [https://peacefromharmony.org/?cat=en\\_c&key=211](https://peacefromharmony.org/?cat=en_c&key=211)

Semashko L., Fihn B., editors and 36 coauthors from 21 countries. *Anti-Nuclear Peace/Cyberspheronics Manifesto: The Noosphere Third Way XXI.2020*: [https://peacefromharmony.org/?cat=en\\_c&key=908](https://peacefromharmony.org/?cat=en_c&key=908)

Semashko L., Siebert R. (2017) *Spherons of Harmony: The Third Way of Religions Reconciliation*: [https://peacefromharmony.org/?cat=en\\_c&key=782](https://peacefromharmony.org/?cat=en_c&key=782)

Semashko L., Аверу Дж., Афанасьева В., Экимович Т. Термодинамика и негэнтропия социетальной гармонии сферных классов: термодинамика глобального мира, 2017 – [https://peacefromharmony.org/?cat=ru\\_c&key=728](https://peacefromharmony.org/?cat=ru_c&key=728)

Semashko L. and 119 coauthors from 34 countries. *Harmonious Civilization*: 2009: [https://peacefromharmony.org/?cat=en\\_c&key=379](https://peacefromharmony.org/?cat=en_c&key=379)

Semashko L. and 174 coauthors from 34 countries. *Global Peace Science*, 2016. – <https://peacefromharmony.org/docs/global-peace-science-2016.pdf>

Semashko L. and GHA 20 coauthors. *Network Spherons: The UN of Harmony and Global Peace Replacing the UN of Disharmony*, 2017 – [https://peacefromharmony.org/?cat=en\\_c&key=769](https://peacefromharmony.org/?cat=en_c&key=769)



- Semashko L. and others.* SPHERONS' Argumentation: Advantages and Disadvantages, 2017. – [https://peacefromharmony.org/?cat=en\\_c&key=747](https://peacefromharmony.org/?cat=en_c&key=747)
- Semashko L. and the GHA 32 coauthors from 13 countries.* Message to BRICS and other Peaceful States Leaders, 2015. – [https://peacefromharmony.org/?cat=en\\_c&key=632](https://peacefromharmony.org/?cat=en_c&key=632)
- Semashko L. and the GHA 75 coauthors from 26 countries.* The ABC of Harmony for World Peace, Harmonious Civilization and Tetranet Thinking, 2012. – [https://peacefromharmony.org/?cat=en\\_c&key=478](https://peacefromharmony.org/?cat=en_c&key=478)
- Semashko L.* Deep Social Structure of SPHERONS' Harmony: Copernican Revolution of Sociology in the XXI Century, 2017. – [https://peacefromharmony.org/?cat=en\\_c&key=726](https://peacefromharmony.org/?cat=en_c&key=726)
- Semashko L.* Human/Humanity Right to Life, Global Peace and Social Harmony. GHA Declaration 2017: [https://peacefromharmony.org/?cat=en\\_c&key=798](https://peacefromharmony.org/?cat=en_c&key=798)
- Semashko L.* Sociology for Pragmatists. Textbook for the university students. Part 1, St.-Petersburg, 1999. – 376 p. (in Russian). – <https://peacefromharmony.org/docs/sociologiya-dlya-pragmatikov.pdf>
- Semashko L.* Spherical Approach. – St.-Petersburg, Notabene, 1992. – <https://peacefromharmony.org/file/5162/1992-semashko-sferniy-podhod.pdf>
- Semashko L.* Spherons' Sociocybernetic MegaScience, 2018. – [https://peacefromharmony.org/?cat=en\\_c&key=810](https://peacefromharmony.org/?cat=en_c&key=810)
- Semashko L.* Tetrasociology: from Sociological Imagination through Dialogue to Universal Values and Harmony, with 14 co-authors, in three languages. St.-Petersburg State Polytechnic University, 2003, 394p. [https://peacefromharmony.org/?cat=en\\_c&key=149](https://peacefromharmony.org/?cat=en_c&key=149)
- Semashko L.* Tetrasociology: Responses to Challenges. – St.-Petersburg State Polytechnic University, 2002. – [https://peacefromharmony.org/docs/2-1\\_eng.pdf](https://peacefromharmony.org/docs/2-1_eng.pdf)
- Semashko L.* The ABC of Harmony as Sociocybernetics of the Third Order, 2012. – [https://peacefromharmony.org/?cat=en\\_c&key=64](https://peacefromharmony.org/?cat=en_c&key=64)
- Semashko L.* The Software Product Person (SPP) for Harmonious Development and Personal Growth. Information Technology, 2015. – [https://peacefromharmony.org/?cat=en\\_c&key=600](https://peacefromharmony.org/?cat=en_c&key=600)
- Semashko L., Chandra S.* Key to Global Peace Science...: Global Peace Science. Peace science: First Common Good and Human Right, Revolution of Social Sciences, 2015. – [https://peacefromharmony.org/?cat=en\\_c&key=624](https://peacefromharmony.org/?cat=en_c&key=624)
- Semashko L., Chandra S., Pereira T.* The USA Hiroshima: Nuclear Threat to Humanity. GHA Message, 2015. – [https://peacefromharmony.org/?cat=en\\_c&key=630](https://peacefromharmony.org/?cat=en_c&key=630)
- Semashko L., Kashina O.* Global Peace Genetics: Structural Harmony of Russia's Spherons in their Statistics for 2010, 1996 и 1991. Edition 2018. – [https://peacefromharmony.org/?cat=en\\_c&key=836](https://peacefromharmony.org/?cat=en_c&key=836)
- Semashko L., Semashko A.* Psychological Human Genome: Global Peace from Individual Harmony / Global Peace Science, 2015. – P. 232–234. – <https://peacefromharmony.org/docs/global-peace-science-2016.pdf>
- Siebert R.* (2020) The Third Way: [https://peacefromharmony.org/?cat=en\\_c&key=945](https://peacefromharmony.org/?cat=en_c&key=945)
- Spencer-Brown G.* The Laws of Form. London: Allen and Unwin, 1969.
- Stojanović G. R.* (2018). The Role of Education in Reducing the Threat of Nuclear War. In Cook, B. L. (Eds.), *Handbook of Research on Examining Global Peacemaking in the Digital Age* (pp. 30–44). IGI Global. <http://doi:10.4018/978-1-5225-3032-9.ch003>
- Sustainable Development Goals: <https://www.un.org/sustainabledevelopment/>
- The 2020 NTI Nuclear Security Index: <https://www.nti.org/analysis/reports/2020-nti-nuclear-security-index/>
- The Third Way: Progressive Governance for the 21<sup>st</sup> Century // The White House. 25 April 1999.

The U.N. Treaty on the Prohibition of Nuclear Weapons 2017: [https://www.icanw.org/the\\_treaty](https://www.icanw.org/the_treaty)

*Tonkonogov A.* Cybernetic Consciousness as a Social Phenomenon of the XXI Century. Law and Right. No. 9. 2019. P. 23–27 (In Russian): <https://cyberleninka.ru/article/n/kiberneticheskoe-soznanie-kak-sotsialnyy-fenomen-xxi-veka/viewer>.

*Tonkonogov A.* Cybernetic Society as a Reality of the 21<sup>st</sup> Century // Law and Right. No. 9. 2018. P. 23–27 (In Russian): <https://cyberleninka.ru/article/n/kiberneticheskoe-obschestvo-kak-realnost-xxi-veka/viewer>

*Umpleby S.* Heinz von Foerster and the Mansfield Amendment. Cybernetics & Human Knowing, 2003. – 10 (3–4) – pp. 161–163.

*Valtsev S.* Democracy. The Humanity Sunset. 2018: <https://wowavostok.livejournal.com/9651668.html>

*Valtsev S.* Why is democracy impossible? The Humanity Sunset. 2016: <http://rusmissia.ru/ch-iii-byt-ili-ne-byt/glava-ii-politicheskaya-sistema/2-ob-odnom-ustojchivom-mife/pochemu-demokratiya-nevozmozhna.html>

*Vernadsky V.* (1931) Biosphere and Noosphere: <http://www.rulit.me/books/biosfera-i-noosfera-read-412871-126.html> (and: [https://peacefromharmony.org/?cat=ru\\_c&key=705](https://peacefromharmony.org/?cat=ru_c&key=705))

*Vernadsky Vladimir.* "The Biosphere and the Noosphere," *American Scientist*, Vol. 33, No. 1, January 1945, pp. 1–12: <http://www.jstor.org/stable/27826043>

*Von Foerster H.* On self-organising systems and their environments, in *Self-Organising Systems*, M. C. Yovits and S. Cameron (Eds.), London: Pergamon Press, 1960. – PP. 30–50.

*Von Foerster H.* Understanding Understanding: Essays on Cybernetics and Cognition, Springer-Verlag, Berlin, 2003.

*Von Foerster H., et al.* (Eds), *Cybernetics of Cybernetics*, BCL Report 73.38, Biological Computer Laboratory, Department of Electrical Engineering, University of Illinois, Urbana, IL, 1974.

*Von Foerster H., Mead M., Teuber H. L.* Editors' Introduction to Cybernetics: Circular Causal and Feedback Mechanisms in Biological and Social Systems, Josiah Macy, Jr Foundation, New York, NY, 1953.

*Vygotsky L.* Thought and language. – MIT Press, Cambridge MA, 1962.

*Weizenbaum J.* Computer Power and Human Reason. From Judgement to Calculation. New York: W.H. Freeman and Company, 1976.

*Wiener N.* The human use of human beings. Cybernetics and Society. London, Eyre and Spottiswoode, 1954

*Wiener N.* Cybernetics. Camb. Mass: MIT Press, 1948.

Wiki. Criticism of democracy. [https://en.wikipedia.org/wiki/Criticism\\_of\\_democracy](https://en.wikipedia.org/wiki/Criticism_of_democracy)

*Wittgenstein L.* Philosophical Investigations. – Basil Blackwell, Oxford, 1953.

WOSC. Philosophical-methodological basis of third-order cybernetics. 2020: <https://wosc2020.ipu.ru/>

## Contents

Instead of a preface. Nobel Appeal. <i>Beatrice Fihn, Mairead Maguire, John Avery, Ernesto Kahan</i> . . . . .	6
The Spherons Philosophy. GHA. . . . .	7
I. World Survival Referendum on the “Nuclear Weapons Prohibition” Question. <i>Beatrice Fihn, Leo Semashko</i> . . . . .	8
II. Key Anti-nuclear Ideas of the Manifesto Authors. (Nuclear Weapons: NW)	
Nelson Mandela: South Africa’s Renunciation from Nuclear Weapons as Unprecedented Example of Gandhian Nonviolence. <i>Leo Semashko</i> . . . . .	9
The international youth movement GHHG: in solidarity with the GHA/ICAN. <i>Ndaba Mandela</i> . . . . .	10
Dr. Martin Luther King Jr’s: Nuclear Disarmament through “A Great Fellowship of Love”. <i>Ayo Ayoola-Amale</i> . . . . .	11
It’s an affront to democracy to be ruled by NW. <i>Beatrice Fihn</i> . . . . .	12
Humanity and NW cannot coexist. <i>Setsuko Thurlow</i> . . . . .	12
The criminality of nuclear deterrence/terrorism. <i>Francis A. Boyle</i> , . . . . .	13
Militarism turned into murderous world state terrorism. <i>Mairead Maguire</i> , . . . . .	14
Militarism became world state terrorism in the United States. <i>Johan Galtung</i> . . . . .	15
Nuclear weapons: an absolute evil. <i>John Avery</i> . . . . .	15
NW are genocidal terror “holding the entire world hostage”. <i>Ernesto Kahan</i> . . . . .	15
Just/Spheral Third Way as excluding NW. <i>Norman Kurland</i> . . . . .	16
Gandhian spherons as the greatest force contra NW. <i>Pravat K. Dhal</i> . . . . .	17
Cyberspheronics: strategic project to rid humanity from NW. <i>Andrey Smirnov</i> . . . . .	18
Only mutual trust of the USA and Russia can ban NW. <i>Vladislav Krasnov</i> . . . . .	18
Cyberspheronics as the liberation from the NW cancer. <i>Alexander Semashko</i> . . . . .	19
Department of Peace as the mighty tool contra NW. <i>Robert M. Weir</i> . . . . .	20
The Third Way and religious dimension to ban NW. <i>Rudolph Siebert</i> . . . . .	21
“Substantially new way of thinking” by spherons to ban NW. <i>Bishnu Pathak</i> . . . . .	21
Cyberspheronics as an intellectual instrument to abolish NW. <i>Lucas Pawlik</i> . . . . .	22
Anti-nuclear Gandhian spherons: verification by world statistics. <i>Olga Kashina</i> . . . . .	23
Gandhian spherons: “nonviolence greatest force” contra NW. <i>Maitreyee Roy</i> . . . . .	23
Women: the main resource for the ICAN. <i>Ayo Ayoola-Amale</i> , . . . . .	24
Women and children, 70% of the population: absolute opponents of NW. <i>Théa Marie Robert</i> , . . . . .	25

Gandhian Manifesto: nonviolence sword of the NW world Lernaean Hydra.  
*Takis Ioannides*, . . . . . 25

The US Peace Memorial against genocidal NW. *Michael D. Knox*. . . . . 26

The NW ban: humanity salvation from necrosphere and genetic default.  
*Vladimir Onoprienko*, . . . . . 26

The UN discussion of Anti-Nuclear Manifesto: extremely vital agenda.  
*Guy Crequie* . . . . . 27

COVID-19: a unique opportunity to abolish NW definitely.  
*María Cristina Azcona* . . . . . 27

Times after Hiroshima/Nagasaki End. *Michael Ellis* . . . . . 28

The UN not have a global salvation plan from NW: it is degradation.  
*Alexander Tonkonogov* . . . . . 28

Ideologies and nuclear race. *Ashok Chakravarthy Tholana*, . . . . . 29

Manifesto: scientific peacemaking consciousness to save humanity.  
*Vera Popovich*. . . . . 29

The NW ban: the global problems of ecology, pandemic and others solution.  
*Andrey Semashko* . . . . . 30

The NW: to whom they enable economic rewards? *Bruce L. Cook*, . . . . . 30

“Disarmament to save humanity.” *Heli Habyarimana*. . . . . 31

The spherons: verification by world statistics and education in them.  
*Stephen Amoah*, . . . . . 31

Nuclear Holocaust. *Muhammad Zafar Iqbal, Noor Muhammad Larik*. . . . . 32

Kazakhstan as a nuclear disaster zone. *Uraz Baimuratov*. . . . . 32

Gandhian nonviolence as an alternative of harmony,  
peace and love to nuclear weapons. *Hasina Parvin* . . . . . 33

Nuclear Weapons: Imposed all-out-war; the humanity highest priority is its ban.  
*Alfredo Sfeir-Younis* . . . . . 33

GHH Anti-nuclear. *Terence Barry* . . . . . 34

The best anti-nuclear idea for New Zealand. *Adam Greenwell* . . . . . 34

There is no nuclear weapon in the world. *Urbain Kapoko* . . . . . 35

Red tulips. *Delasnieve Daspét* . . . . . 35

Mahatma Gandhi: non-violence, peace, love instead of nuclear weapons.  
*Anam Kumar* . . . . . 36

The NW ban: “a substantially new manner of thinking” by the spheres/spherons.  
*Leo Semashko*. . . . . 36

Cybernetics to help us construct our understandings. *Bernard Scott* . . . . . 37

III. Manifesto Definitions.  
Nuclear Weapons Prohibition and its Fundamental condition.  
*Leo Semashko*. . . . . 37

IV. Global Security/Peace (GSP). Existential Laws. <i>Leo Semashko</i> . . . . .	39
V. Cyberspheronics. The Societal GSP Science: Theory/Thinking. <i>Leo Semashko, Bernard Scott, Olga Kashina, Stephen Amoah, Lucas Pawlik ...</i> . . . . .	42
VI. Cyberspheronics Pragmatics. The Best Global Security is Global Peace <i>Leo Semashko</i> . . . . .	62
VII. ICAN/GHA Epilogue. Citizens of the Earth! <i>Beatrice Fihn, Leo Semashko</i> . . . . .	67
VIII. Appendixes.	
“The Anti-Nuclear Manifesto” Final Formula: The Humanity Gandhian Evolution Cognitive Pragmatics. <i>Leo Semashko</i> . . . . .	68
Appendix 1. Tragedy and Triumph of Reason. Evgeny Chazov . . . . .	69
Appendix 2. Remember Hiroshima and Nagasaki!. . . . .	71
Appendix 3. I Know How To Build A Society Without War: Interview of Leo Semashko for the World Growth Forums Magazine, October 2020 . . . . .	72
Appendix 4. The GHA two Messages “I KNOW HOW” to the UN online book. <i>Leo Semashko</i> . . . . .	77
Appendix 5. Nuclear weapons are illegal now! <i>Beatrice Fihn</i> . . . . .	78
Appendix 6. Nuclear weapons are illegal now! But our work is not done still! <i>Leo Semashko</i> . . . . .	79
Appendix 7. Gandhica: Holistic Mega-Thinking for the UN and Humanity. <i>Leo Semashko et al.</i> . . . . .	81
Appendix 8. To Prime Minister of Japan. To Sign and Ratify the Treaty on the Prohibition of Nuclear Weapons (TPNW). Japan Council against A and H Bombs . . . . .	82
Appendix 9. Signature Campaign to Urge Japan to join TPNW Launched . . . . .	83
Appendix 10. On the Occasion of the Fiftieth Country’s Deposition of Instrument of Ratification (Accession) of the Treaty on the Prohibition of Nuclear Weapons. October 25,2020. Japan Confederation of A-and H-Bomb Sufferers Organizations. ( <i>Nihon Hidankyo</i> ) . . . . .	84
IX. Pragmatic Resume for the UN Spherons Discussion/Polylogue . . . . .	86
Bibliography . . . . .	89
Contents . . . . .	97

**Leo Semashko, editor and 46 coauthors from 26 countries.  
Anti-Nuclear Peace/Cyberspheronics Manifesto:  
The Noosphere Third Way XXI.**

The GHA 78th project. Approved on June 21, 2020.

Published by Licorne International, New Delhi. 2020. – 100 p.  
ISBN 978-81-949473-0-1

First publication in English in India,  
Licorne International,  
2B, Second Floor, Basant Kaur Marg,  
Malviya Nagar, New Delhi – 110017

Year- 2020

100 p.

Price: Rs. 210/- \$ 3

Hardbound: Rs. 350/- \$ 5

Printed from the original layout: Leo Semashko  
at Licorne International,

2B, Second Floor, Basant Kaur Marg, Malviya Nagar, New Delhi – 110017

Signed to print by Leo Semashko on November 8, 2020

With this colophon page I approve

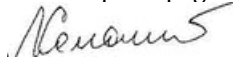

05. 12. 20



# Hiroshima/Nagasaki (H/N) are 75

<https://peacefromharmony.org/manifesto>

**Humanity and the Planet are the hostages of suicidal nuclear weapons, 14 thousand units of which are aimed at us.**

**When do we expect the H/N fate, if there are only 100 seconds left before it on the nuclear scientists Doomsday Clock?**

<https://peacefromharmony.org/100seconds>

Therefore, today for humanity and each individual [there is nothing more vital important](#) than banning nuclear weapons.

---

**Earth Citizens:  
SOS!**



**Anti-Nuclear Manifesto  
ICAN/GHA 2020**

[peacefromharmony.org/manifesto](https://peacefromharmony.org/manifesto)

Nobel Appeal

World Survival Referendum

Authors Anti-Nuclear Ideas

Manifesto Definitions

Global Security/Peace (GSP) System

Cyberspheronics. GSP Science

Cyberspheronics Pragmatics

ICAN/GHA Epilogue

---

## The genocidal nuclear threat reasons are known:

- Pathological politics of global confrontation,
- The military-industrial complex: which designs, improves and manufactures nuclear weapons,
- Traditional democracy, with priority and generous funding it with military budgets.

**The ICAN/GHA Anti-Nuclear Manifesto** is a paradigm of Gandhian thinking and a scientific global security/peace system that overcome and eradicate this threat.

The humanistic and peace meaning of the book "**Anti-Nuclear Manifesto XXI**" for the UN General Assembly is that in 75 years, the UN will begin to build a fundamental system of Global Security/Peace (GSP) on the genetic societal basis of the humanity Gandhian spherons, verified by world statistics. The GSP excludes any possibility of nuclear weapons and wars and opens the Nonviolence Era in 2020.

# Gandhian Spherons of Humanity: Global Security / Peace

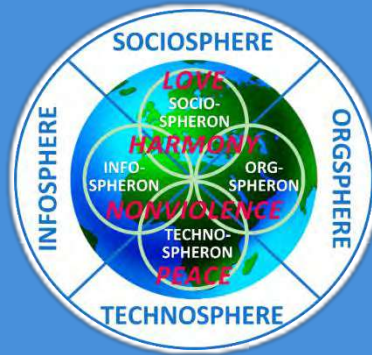

Peace / Cyberspheronics Manifesto:  
The Noosphere Third Way XXI

<https://peacefromharmony.org/manifesto>

---

**The quick and ethical path to nuclear disarmament is:  
from Gandhi via King and Mandela to the nonviolence-XXI  
world leaders able by consently to repeat their spiritual  
renunciation of nuclear weapons to save humanity and biosphere.**

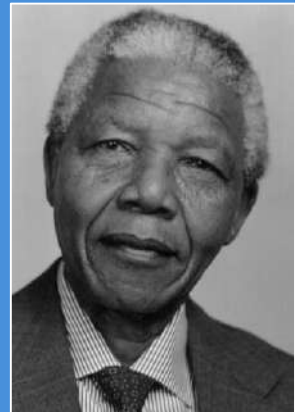
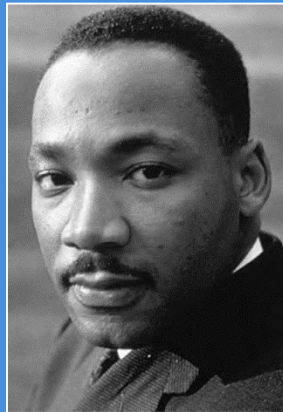
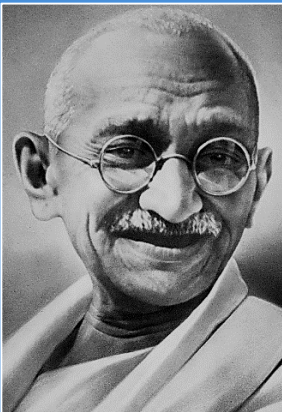

**But today, Gandhi, King, Mandela and their very rare adherents  
remain dissidents of the violence era and at its leaders.**

*"Nelson Mandela is undoubtedly one of the outstanding world figures in the 20<sup>th</sup> and 21<sup>st</sup> centuries, and his magnitude compares to that of Mahatma Gandhi and Alexander Solzhenitsyn... Courageous and wise, Nelson Mandela always fought consistently for his convictions but remained a great humanist and peacemaker. This approach is needed in today's world: the search for compromises is the best basis for consensus and cooperation,"*  
the Russian President wrote in the condolence book at the South African embassy:

<https://peacefromharmony.org/gandhi>